



MID-AMERICA
TRANSPORTATION CENTER



Report # TRP-03-275-12

Final Report
25-1121-0001-428

Cable Median Barrier Failure Analysis and Prevention

Dean L. Sicking, Ph.D., P.E.

Professor

Department of Civil Engineering
University of Nebraska-Lincoln

Cody S. Stolle, Ph.D., E.I.T.

Postdoctoral Research Associate

2012

Nebraska Transportation Center
262 WHIT
2200 Vine Street
Lincoln, NE 68583-0851
(402) 472-1975

NTC

"This report was funded in part through grant[s] from the Federal Highway Administration [and Federal Transit Administration], U.S. Department of Transportation. The views and opinions of the authors [or agency] expressed herein do not necessarily state or reflect those of the U. S. Department of Transportation."



*MATC University Transportation Center Research Program
Fiscal Years 2010-2012*

CABLE MEDIAN BARRIER FAILURE ANALYSIS AND PREVENTION

Submitted by

Cody S. Stolle, Ph.D., E.I.T.
Postdoctoral Research Associate

Dean L. Sicking, Ph.D., P.E.
Professor, Civil Engineering

MIDWEST ROADSIDE SAFETY FACILITY

Nebraska Transportation Center
University of Nebraska-Lincoln
130 Whittier Research Center
2200 Vine Street
Lincoln, Nebraska 68583-0853
(402) 472-0965

Submitted to

MIDWEST STATES REGIONAL POOLED FUND PROGRAM

Nebraska Department of Roads
1500 Nebraska Highway 2
Lincoln, Nebraska 68502

MID-AMERICA TRANSPORTATION CENTER

U.S. Department of Transportation, Region VII University Transportation Center
University of Nebraska-Lincoln
2200 Vine Street, 262 Whittier Building
Lincoln, Nebraska 68583-0853

MwRSF Research Report No. TRP-03-275-12

December 17, 2012

TECHNICAL REPORT DOCUMENTATION PAGE

| | | | |
|--|---|---|-----------|
| 1. Report No. TRP-03-275-12 | 2. | 3. Recipient's Accession No. | |
| 4. Title and Subtitle Cable Median Barrier Failure Analysis and Prevention | | 5. Report Date December 17, 2012 | |
| | | 6. | |
| 7. Author(s) Stolle, C.S. and Sicking, D.L. | | 8. Performing Organization Report No. TRP-03-275-12; MATC WBS: 25-1121-0001-428 | |
| 9. Performing Organization Name and Address Midwest Roadside Safety Facility (MwRSF) Nebraska Transportation Center University of Nebraska-Lincoln 130 Whittier Research Center 2200 Vine Street Lincoln, Nebraska 68583-0853 | | 10. Project/Task/Work Unit No. | |
| | | 11. Contract © or Grant (G) No. | |
| 12. Sponsoring Organization Name and Address Midwest States Regional Pooled Fund Program Nebraska Department of Roads 1500 Nebraska Highway 2 Lincoln, Nebraska 68502 Mid-America Transportation Center U.S. Department of Transportation Region VII University Transportation Center University of Nebraska-Lincoln 2200 Vine Street 262 Whittier Building Lincoln, Nebraska 68583-0853 | | 13. Type of Report and Period Covered Final Report: 2010 – 2012 | |
| | | 14. Sponsoring Agency Code MATC TRB RiP No. 28495 | |
| 15. Supplementary Notes | | | |
| 16. Abstract (Limit: 200 words) <p>Cross-median crashes have been identified as one of the highest injury or fatality risk crash types. Although cross-median crashes account for only 2% to 5% of all median crash events, they are disproportionately represented in the number and frequency of fatalities on interstate roadways. Many states have utilized cable median barriers to reduce the risk of cross-median crashes, frequently with great success.</p> <p>However, cable median barriers are also fixed obstacles to errant vehicles. Cable median barriers can place occupants at increased risk of severe injury or fatality if the barrier fails to adequately contain and redirect errant vehicles, resulting in a vehicular penetration through the barrier or rollover. As total cable median barrier mileage continues to climb, there is an opportunity to prevent many penetration, rollover, and serious injury or fatality crashes by improving barrier design, installation guidelines, and crash-testing guidelines to more adequately address crash concerns with these barrier types. More than 6,000 cable median barrier crashes from 12 different states were analyzed to determine causes of barrier containment failures, and new crash test conditions which were reflective of these impact conditions were identified. Further crash testing and barrier redesign should reduce the frequency of barrier penetrations and rollovers.</p> | | | |
| 17. Document Analysis/Descriptors Highway Safety, Roadside Appurtenances, Cable Barriers, Impact Conditions, In-Service Performance | | 18. Availability Statement No restrictions. Document available from: National Technical Information Services, Springfield, Virginia 22161 | |
| 19. Security Class (this report) Unclassified | 20. Security Class (this page) Unclassified | 21. No. of Pages 216 | 22. Price |

DISCLAIMER STATEMENT

This report was completed with funding from the Federal Highway Administration, U.S. Department of Transportation. The contents of this report reflect the views and opinions of the authors who are responsible for the facts and the accuracy of the data presented herein. The contents do not necessarily reflect the official views or policies of the state highway departments participating in the Midwest States Regional Pooled Fund Program nor the Federal Highway Administration, U.S. Department of Transportation. This report does not constitute a standard, specification, regulation, product endorsement, or an endorsement of manufacturers.

ACKNOWLEDGEMENTS

The authors wish to acknowledge several sources that made a contribution to this project:

(1) the Illinois Department of Transportation, Iowa Department of Transportation, Kentucky Department of Transportation, Minnesota Department of Transportation, Missouri Department of Transportation, North Carolina Department of Transportation, Ohio Department of Transportation, Ohio Department of Public Safety, Ohio Highway State Patrol, Oklahoma Department of Transportation, Oregon Department of Transportation, Texas Department of Transportation, Utah Department of Transportation, Washington Department of Transportation, Wisconsin Department of Transportation for providing crash data; and (2) MwRSF personnel for constructing the barriers and conducting the crash tests.

Acknowledgement is also given to the following individuals who made a contribution to the completion of this research project.

Midwest Roadside Safety Facility

F.D.B. Albuquerque, Ph.D., Research Assistant Engineer
J.D. Reid, Ph.D., Professor
R.K. Faller, Ph.D., P.E., Research Assistant Professor
K.A. Lechtenberg, M.S.M.E., E.I.T., Research Associate Engineer
R.W. Bielenberg, M.S.M.E., E.I.T., Research Associate Engineer
M. Mongiardini, Ph.D., Post-Doctoral Research Assistant
Y. Shi, M.S.STAT, Undergraduate Assistant

Illinois Department of Transportation

David Piper, P.E., Safety Implementation Engineer
Priscilla Tobias, State Safety Engineer

Iowa Department of Transportation

Chris Poole, P.E., Roadside Design Engineer
Michael Pawlovich, Ph.D., P.E., Office of Traffic and Safety

Kentucky Department of Transportation

Nathan Dean, Traffic Records Coordinator

Minnesota Department of Transportation

Michael Elle, P.E., Design Standard Engineer

Missouri Department of Transportation

Joseph G. Jones, P.E., Engineering Policy Administrator
Jon Nelson, P.E., Traffic Management and Operations Engineer
John P. Miller, P.E., Traffic Safety Engineer
Darla Stumpe, P.E., Sr. Traffic Studies Specialist

North Carolina Department of Transportation

Shawn Troy, P.E., Safety Evaluation Engineer
Brian G. Murphy, P.E., Traffic Safety Project Engineer

Oklahoma Department of Transportation

Matt Warren, E.I.T., Traffic Division
Faria Emamian, P.E., Assistant Division Engineer

Ohio Department of Transportation

Michael Bline, P.E., Standards and Geometrics Engineer
Jeffery Maute, Department of Public Records
Ohio Department of Public Safety
Sgt. John Thorne, Ohio State Highway Patrol

Oregon Department of Transportation

Dave Thompson, Public Information Section Manager

Texas Department of Transportation

Rory Meza, P.E., Director, Roadway Design Section

Utah Department of Transportation

W. Scott Jones, P.E., PTOE, Safety Programs Engineer
Danielle Herrscher, P.E., Crash Studies Engineer
Glenn Schulte, Transportation Safety Specialist

Washington Department of Transportation

Dave Olson, Design Policy, Standards, and Research Manager
Brad Manchias, Design Research Analyst

Wisconsin Department of Transportation

Jerry Zogg, P.E., Chief Roadway Standards Engineer

John Bridwell, P.E., Standards Development Engineer

Erik Emerson, P.E., Standards Development Engineer

Sgt. Duane Meyers, Technical Reconstruction Unit Supervisor, Wisconsin State Patrol Academy

Trooper Ryan Zukowski, Wisconsin State Patrol Academy

TABLE OF CONTENTS

TECHNICAL REPORT DOCUMENTATION PAGE i

DISCLAIMER STATEMENT ii

ACKNOWLEDGEMENTS iii

TABLE OF CONTENTS vi

LIST OF FIGURES ix

LIST OF TABLES xi

1 INTRODUCTION 1

 1.1 Problem Statement 1

 1.2 Research Objective 2

 1.3 Scope 2

2 LITERATURE REVIEW 3

3 STATE BARRIER INSTALLATION GUIDELINES 8

 3.1 Summary of Barrier Installation Practice by State 8

 3.2 Reference Definitions 11

4 SUMMARY OF CABLE BARRIER CRASHES 14

 4.1 Description of Study 14

 4.2 Cable Barrier Impacts 18

 4.2.1 Weather and Road Conditions 19

 4.2.2 Weather Conditions and Barrier Type 27

 4.2.3 Weather and Time of Year 29

 4.2.4 Slope Characteristics 31

 4.2.5 Vehicle Types 40

 4.2.6 Vehicles Involved in Cable Median Barrier Crashes 44

 4.2.7 Impact Conditions 52

 4.2.8 Comparison of Missouri and North Carolina 60

 4.2.9 Crash Severity 62

 4.3 Discussion 67

 4.4 Conclusions 68

5 CASE STUDY OF CABLE MEDIAN BARRIER PERFORMANCE 70

 5.1 Weather Conditions 70

 5.2 Traffic Volumes 71

 5.3 Avoidance Maneuvers 71

 5.4 Median Geometries 72

 5.5 Barrier Placement 73

 5.6 Conclusions 73

| | |
|--|-----|
| 6 CAUSES OF CABLE MEDIAN BARRIER PENETRATIONS | 76 |
| 6.1 System Design Details | 76 |
| 6.1.1 Nucor NU-CABLE TL-3 3-Cable System..... | 76 |
| 6.1.2 Trinity Cable Safety System (CASS) 3-Cable Barrier | 82 |
| 6.1.3 Brifen TL-3 Wire Rope Safety Fence (WRSF) | 87 |
| 6.1.4 Low-Tension, 3-Cable Median Barrier | 91 |
| 6.2 Overview of Crash Data..... | 98 |
| 6.3 Types of Penetrations..... | 100 |
| 6.3.1 Diving Penetrations..... | 100 |
| 6.3.2 Prying Underride Failures..... | 101 |
| 6.3.3 Bounce-Over Penetrations | 102 |
| 6.3.4 Override Penetrations..... | 103 |
| 6.3.5 Low CG Trajectory Angle Penetrations | 103 |
| 6.4 Approximate Equivalent Vehicle Profile..... | 104 |
| 6.5 Cable Tension and Dynamic Deflection | 106 |
| 6.6 Energetic Capture Concept | 108 |
| 6.7 Overall Discussion and Recommendations | 110 |
| 7 PENETRATION CRASH ANALYSIS | 114 |
| 7.1 Nucor TL-3 System on Flange Channel Posts | 114 |
| 7.1.1 Override Penetrations..... | 114 |
| 7.1.2 Prying Underride Penetrations | 121 |
| 7.1.3 Diving Underride Penetrations | 127 |
| 7.1.4 Nucor NU-CABLE Penetrations Discussion | 130 |
| 7.2 Trinity CASS Cable Barrier..... | 131 |
| 7.2.1 Ramp Formation Override Penetrations | 131 |
| 7.2.2 Prying Underride Penetrations | 132 |
| 7.2.3 Low CG Trajectory Angle Penetrations | 135 |
| 7.2.4 Diving Underride Penetrations | 136 |
| 7.2.5 Trinity CASS Penetrations Discussion | 137 |
| 7.3 Brifen Wire Rope Safety Fence (WRSF)..... | 138 |
| 7.3.1 Prying Underride Penetrations | 138 |
| 7.3.1.1 Other Penetration Types | 141 |
| 7.3.1.2 Brifen WRSF Penetration Discussion..... | 141 |
| 7.3.2 Low-Tension Non-Proprietary 3-Cable Median Barrier..... | 142 |
| 7.3.2.1 Override Penetration Crashes | 142 |
| 7.3.2.2 Diving Underride Crashes..... | 143 |
| 7.3.2.3 Prying Underride Penetrations | 147 |
| 7.3.2.4 System Failures | 156 |
| 7.3.2.5 Other Penetration Causes | 156 |
| 7.3.2.6 Discussion | 159 |
| 8 CAUSES OF CABLE MEDIAN BARRIER ROLLOVERS | 161 |
| 8.1 Overview of Crash Data..... | 161 |
| 8.2 Rollover Analysis..... | 162 |
| 8.2.1 Steep Median Slope Rollovers..... | 162 |
| 8.2.2 Broadside Skid Rollovers | 167 |

| | |
|--|-----|
| 8.2.3 Contact with Post Rollovers..... | 173 |
| 8.2.4 Other Rollover Causes | 180 |
| 8.3 Discussion..... | 180 |
| 9 DISCUSSION | 183 |
| 9.1 Penetration Crashes..... | 183 |
| 9.2 Rollover Crashes..... | 185 |
| 9.3 Barrier Placement and Median Grading | 186 |
| 9.4 Full-Scale Crash Testing..... | 190 |
| 9.4.1 Background..... | 190 |
| 9.4.2 Cable Barrier Crash Observations | 191 |
| 10 SUMMARY AND CONCLUSIONS | 196 |
| 11 RECOMMENDATIONS..... | 201 |
| 11.1 Modifications to Barrier Designs..... | 201 |
| 11.1.1 Cable-to-Post Attachments and Vertical Positions | 201 |
| 11.1.2 Cable Tension | 203 |
| 11.1.3 Number of Cables | 203 |
| 11.1.4 Summary of Design Improvements | 204 |
| 11.2 Barrier Placement in Medians..... | 205 |
| 11.3 Full-Scale Crash Testing..... | 205 |
| 11.3.1 Full-Scale Crash Testing on Slopes | 205 |
| 11.3.2 Impact Conditions | 206 |
| 11.3.3 Vehicle Selection | 207 |
| 11.3.4 Summary of Full-Scale Crash Testing Recommendations | 208 |
| 12 REFERENCES | 210 |
| 13 ADDITIONAL RELEVANT STUDIES | 215 |

LIST OF FIGURES

| | |
|---|-----|
| Figure 1. Selected Approximate Barrier Locations with Annual Precipitation Estimates [16].... | 22 |
| Figure 2. Crash Frequency and Severity by Week Number | 30 |
| Figure 3. Crash Frequency and Severity by Month | 31 |
| Figure 4. Statistical Analysis of Penetration and Rollover Risk by Median Slope | 37 |
| Figure 5. Estimated Median Approach Slope Risk Curves by Approach Slope Grade..... | 37 |
| Figure 6. Estimated Median Approach Slope Risk Curves by Approach Slope Steepness..... | 38 |
| Figure 7. Vehicle Types Involved in Cable Barrier Crashes | 41 |
| Figure 8. Frequency of Barrier Failure by Vehicle Type..... | 41 |
| Figure 9. Risk of A+K Crash by Vehicle Type | 42 |
| Figure 10. Frequency of Severe Injury by Crash Result and Vehicle Type | 43 |
| Figure 11. Distribution of Vehicle Wheelbase in CMB Impacts by Crash Result | 45 |
| Figure 12. Distribution of Vehicle Wheelbase in Severe CMB Impacts by Crash Result | 45 |
| Figure 13. Distribution of Longitudinal CG Location in CMB Impacts by Crash Result..... | 46 |
| Figure 14. Distribution of Longitudinal CG Location in Severe CMB Impacts by Crash Result | 46 |
| Figure 15. Distribution of Curb Weight in CMB Impacts by Crash Result | 47 |
| Figure 16. Distribution of Curb Weight in CMB Impacts, All Crashes | 47 |
| Figure 17. Distribution of Curb Weight in CMB Impacts, Penetration and Rollover Crashes | 48 |
| Figure 18. CG Trajectory and Orientation Angles in Severe Cable Median Barrier Crashes | 53 |
| Figure 19. CG Trajectory and Sideslip Angles in Severe Cable Median Barrier Crashes | 53 |
| Figure 20. Comparison of Trajectory Angle Distributions..... | 55 |
| Figure 21. CG Trajectory and Orientation Angles by Crash Result | 56 |
| Figure 22. Detail View of Severe Crash CG Trajectory and Orientation Angles in Missouri | 57 |
| Figure 23. Cumulative Distribution of CG Trajectory Angles by Severe Crash Result..... | 59 |
| Figure 24. Probability Distribution of Containment Failure in Severe Crashes | 60 |
| Figure 25. Comparison of North Carolina, Missouri, and NCHRP Crashes | 61 |
| Figure 26. Nucor Cable Barrier Design Details [29] | 77 |
| Figure 27. Nucor Cable Barrier Design Details [29] | 78 |
| Figure 28. Nucor Cable Barrier Long Clip Design Details [30]..... | 79 |
| Figure 29. Nucor Cable Barrier Short Clip Design Details [30]..... | 80 |
| Figure 30. Vertical Pullout Moment Couple on Nucor Cable-To-Post Attachment..... | 81 |
| Figure 31. Trinity CASS C-Shape Post System Details [31]..... | 83 |
| Figure 32. Trinity CASS C-Shaped Post System Details [31]..... | 84 |
| Figure 33. Trinity CASS TL-3 S-Post System Details [32]..... | 85 |
| Figure 34. Trinity CASS TL-3 S-Post System Details [32]..... | 86 |
| Figure 35. Typical TL-3 Brifen WRSF Design Details [34] | 88 |
| Figure 36. Typical TL-3 Brifen WRSF Design Details [34] | 89 |
| Figure 37. Typical TL-3 Brifen WRSF Surface-Mounted Post Design Details [34] | 90 |
| Figure 38. Low-Tension 3-Cable Median Barrier Standard Plans, North Carolina DOT, 2002 .. | 92 |
| Figure 39. Low-Tension 3-Cable Median Barrier Standard Plans, North Carolina DOT, 2002 .. | 93 |
| Figure 40. Low-Tension 3-Cable Median Barrier Standard Plans, North Carolina DOT, 2002 .. | 94 |
| Figure 41. Low-Tension 3-Cable Median Barrier Standard Plans, North Carolina DOT, 2002 .. | 95 |
| Figure 42. Low-Tension 3-Cable Median Barrier Standard Plans, North Carolina DOT, 2002 .. | 96 |
| Figure 43. Low-Tension 3-Cable Median Barrier Standard Plans, North Carolina DOT, 2002 .. | 97 |
| Figure 44. Approximate Equivalent Vehicle Profile Concept | 105 |
| Figure 45. Dynamic Deflection Comparison, Low- and High-Tension Cable Barriers | 107 |

Figure 46. Penetration Crash Caused by Strong Cable-to-Post Attachment 115
Figure 47. Crash Result Due to Strong Cable-to-Post Connection..... 116
Figure 48. Override Penetration Crash Caused by Strong Cable-to-Post Attachment 119
Figure 49. Override Penetration Crash Vehicle Final Position and Removed Bumper Cover... 120
Figure 50. Prying Penetration Crash on Nucor NU-CABLE Barrier 123
Figure 51. Prying Penetration Failure on Nucor NU-CABLE Barrier 124
Figure 52. Potential Penetration Crash on Nucor NU-CABLE Barrier..... 126
Figure 53. Diving Underride Penetration Crash on Nucor NU-CABLE Barrier..... 128
Figure 54. Diving Potential Underride Penetration Crash on Nucor NU-CABLE Barrier 129
Figure 55. Scene Diagram of High-Orientation Angle Crash..... 133
Figure 56. 2002 Dodge Stratus Similar to Vehicle Involved in High-Orientation Angle
Penetration Crash [33] 134
Figure 57. Prying Underride Failure on Brifen WRSF..... 139
Figure 58. High-Angle Override Penetration Crash Example 143
Figure 59. Diving Underride Penetration Crash in North Carolina 146
Figure 60. Additional Example of Diving Penetration Crash..... 148
Figure 61. Additional Example of Diving Penetration Crash..... 149
Figure 62. Comparison of Prying Penetration CG Trajectory and Orientation Angles..... 150
Figure 63. Middle Cable Release from Many Downstream Posts Resulting in Penetration 152
Figure 64. Middle Cable Release from 11 Downstream Posts Resulting in Penetration 153
Figure 65. Prying Penetration Failure with SUV Caused by Brush Guard 154
Figure 66. Brush Guard Prying Penetration with Cable Contact Striations on A-Pillar..... 155
Figure 67. High-Tension Splice Tearout Penetration 157
Figure 68. High-Tension Splice Tearout Penetration 158
Figure 69. Entrapment Rollover Crash in which Vehicle Extends Over SBP of 6:1 Slope 164
Figure 70. Example Rollover Crash Caused by High Redirection on Back Slope..... 165
Figure 71. Example Rollover Crash Caused by Redirection on Back Slope (continued) 166
Figure 72. Impact at High Orientation Angle with Unbalanced Force Diagram..... 169
Figure 73. Example Rollover Crash Caused by High Orientation Angle at Impact..... 170
Figure 74. Example Rollover Crash Caused by High Orientation Angle at Impact..... 171
Figure 75. Example Rollover Crash Caused by High Orientation Angle at Impact..... 172
Figure 76. Example of Post Snag Rollover Crash 174
Figure 77. Example of Post Snag Rollover Crash 175
Figure 78. High-Tension Post Section Shapes..... 178
Figure 79. Y-Axis (Typ. Weak Axis) Yield Moment Relationship with Rollover Frequency... 179
Figure 80. X-Axis (Typ. Strong Axis) Yield Moment Relationship with Rollover Frequency . 179
Figure 81. Gibraltar System Details, TL-3 System [44]..... 184
Figure 82. Cable Median Barrier Stratification Concept 202
Figure 83. Representative Crash Testing Impact Diagram 208

LIST OF TABLES

| | |
|--|-----|
| Table 1. Average Number of Days with Rainfall in Select Surveyed States..... | 20 |
| Table 2. Average Number of Days with Snowfall in Select Surveyed States | 20 |
| Table 3. Average Monthly Precipitation in Select Surveyed States | 21 |
| Table 4. Average Monthly Snowfall in Select Surveyed States | 21 |
| Table 5. Crash Result in States by Predominant Weather Condition | 24 |
| Table 6. Crash Result in States with Complete Data Sets by Predominant Weather Condition .. | 24 |
| Table 7. Crash Result in States by Predominant Road Condition | 25 |
| Table 8. Crash Result in States with Complete Data Sets by Predominant Road Condition | 25 |
| Table 9. Average Rates of Barrier Containment Failure by Predominant Weather Condition | 26 |
| Table 10. Average Rates of Barrier Containment Failure by Predominant Road Condition | 26 |
| Table 11. Crash Result per System in States with Complete Data Sets by Predominant Weather Condition..... | 28 |
| Table 12. Crash Result per System in States with Complete Data Sets by Predominant Road Condition..... | 28 |
| Table 13. Crash Results for Flat or V-Ditch Medians with Barriers on Traffic-Side Slopes | 33 |
| Table 14. Crash Results for V-Ditch Medians with Barriers in Center of Ditch..... | 33 |
| Table 15. Crash Results for V-Ditch Medians with Barriers Installed on Back Slope..... | 34 |
| Table 16. Missouri’s Severe Penetration Crash Median Slope Summary | 39 |
| Table 17. Missouri’s Severe Rollover Crash Median Slope Summary | 39 |
| Table 18. Test Vehicle Dimensions and Weights | 48 |
| Table 19. Crash Severities by System Type and Penetration Crash Outcome | 63 |
| Table 20. Crash Severities by System Type and Rollover Crash Outcome..... | 63 |
| Table 21. Risk Factor Summary for Barrier Systems | 64 |
| Table 22. Crash Severity by Barrier Location | 66 |
| Table 23. Causes of Penetrations | 99 |
| Table 24. Ohio Cable Median Barrier Location Severity and Crash Result..... | 112 |
| Table 25. Causes of Rollovers with Cable Median Barriers..... | 162 |
| Table 26. Summary of Post Characteristics in High-Tension Cable Guardrail Systems..... | 176 |
| Table 27. Standard Cable Heights and Tensions | 177 |
| Table 28. Vehicles Frequently Involved in (a) High Penetrations and (b) High Rollovers..... | 192 |
| Table 29. Summary of Barrier Design Improvement Recommendations..... | 204 |
| Table 30. Recommended Crash Testing Impact Conditions for Cable Median Barriers | 208 |

THIS PAGE INTENTIONALLY LEFT BLANK

1 INTRODUCTION

1.1 Problem Statement

A cross-median crash is the most severe type of run-off-road event in the United States. Cross-median crashes represent approximately 2% to 5% of all divided interstate crashes; yet fatalities and serious injuries occur in as much as 30% of these crashes. With the significantly disproportionate number of severe crashes occurring due to cross-median crash events, many states have turned to cable median barriers to reduce the risk of these types of severe crashes.

Cable median barriers have been extensively studied to determine the cost-effectiveness of installation, in-service performance, rate of severe injury, fatality reduction, and maintenance and post-impact performance evaluation. For examples of these studies, the reader is encouraged to refer to Chapter 13.

However, cable median barriers are median obstacles as well. They can place occupants at increased risk of severe injury or fatality if the barriers fail to adequately contain and redirect errant vehicles, resulting in rollover or vehicular penetration through the barrier. Furthermore, these barriers are also involved in many non-rollover, non-penetration fatalities and serious injuries, though no concerted effort has yet been made to determine the causes of these serious and fatal injuries.

Many industry experts expect the total mileage of cable median barrier to double within the next 10 years. As total cable median barrier mileage continues to climb, there is an opportunity to prevent many penetration, rollover, and serious injury or fatality crashes by improving barrier design, installation guidelines, and crash-testing guidelines to mitigate crash concerns with these barrier types.

1.2 Research Objective

The objective of this study was to evaluate cable median barrier crashes across a broad spectrum of states to determine containment failure causation and preventative measures to improve motorist safety performance.

1.3 Scope

In order to accomplish the research objective, a series of tasks were undertaken, and are summarized as follows:

- (1) Cable barrier crash data was requested from many states with prominent histories of studying cable median barriers;
- (2) Crash data was analyzed and segregated by state, vehicle type, vehicle class, impact conditions, median geometry, barrier type, crash result, crash severity, and containment failure mechanism; and
- (3) Containment failure mechanisms of cable barriers were evaluated extensively using a combination of scene diagrams, crash narratives, photographic evidence, site measurements, and crash reconstruction techniques.

Additional studies are planned in the future to address specific vehicle types in vehicle-to-barrier interactions which may aggravate penetration or rollover tendencies.

2 LITERATURE REVIEW

Much of the U.S. freeway system was designed and constructed in the 1950s and 1960s. During this time, it was common to build high-speed facilities with 30-ft (9-m) and 40-ft (12-m) wide medians. With the low traffic volumes found on freeways during this period, the frequency of tragic cross-median crashes was low. The California Department of Transportation (Caltrans) conducted a study to determine the benefits of using cable barriers in these relatively narrow medians [1]. This study indicated that barriers could not be justified in medians wider than 50 ft (15 m). Caltrans repeated this study several times between 1973 and 1993. Each time, the authors arrived at the same conclusion; barriers were not cost-effective when installed in medians wider than 50 ft (15 m), despite rising traffic volumes. However, findings from the 1997 version of this study were quite different and recommended that barriers be placed in medians as wide as 75 ft (22 m) [2]. The primary change between the 1997 study and the preceding study from 1993 was the elimination of the national speed limit law. Elimination of this law produced a speed limit increase on most rural freeways of 15 to 20 mph (24 to 32 km/h). This magnitude of speed increase could easily explain the large increase in cross-median crashes and the differences in the benefits of using cable median barriers.

Following a trend of a high rate of cross-median crashes and associated fatalities, the North Carolina Department of Transportation (DOT) investigated the use of median barriers between 1997 and 2004, to mitigate the severity of median crashes and to reduce the frequency of cross-median crash events [3-4]. This pilot study analyzed 400 miles (644 km) of interstate with barrier, which included 175 miles (282 km) of cable barrier and an additional 44 miles (71 km) of cable barrier and W-beam combinations. Researchers observed a 71% drop in the number of cross-median crashes and associated fatalities or serious injuries due to the introduction of these cable median barriers. The total drop in severe and fatal injuries was 35% over this same

period, while moderate injuries increased by 26%. The reason for the disparity between the drops in cross-median crash rates and severe crash rates is that, any barrier system which can be struck by an errant motorist is a roadside obstacle. Every roadside obstacle can contribute to the number and frequency of severe crashes. Researchers postulated that by installing cable median barriers, 95 cross-median crashes were prevented and more than 100 lives were saved. The barriers prevented a large number of cross-median crashes and were ultimately successful in significantly reducing cumulative A+K crash frequency. Even though cable median barriers were very effective at reducing the number of cross-median crashes, cable median barriers also contributed to fatalities unassociated with cross-median events. Therefore, it is necessary to investigate methods of reducing the number of unassociated fatalities as well as barrier penetration frequency to further improve roadside safety with respect to these barriers.

A similar study was conducted at Rowan University in 2005, identifying types of median barriers and crash histories for the New Jersey Department of Transportation [5]. Although a net safety improvement was noted after median barrier installations, the crash frequency increased. Also, researchers noted that after cable barrier hits, maintenance personnel were slow to repair barriers often allowing the cables to sag to the ground in impact regions for up to several weeks.

The Wisconsin DOT also investigated the correlation between cross-median crashes on the number of cross-median fatalities [6]. Researchers observed that between 2001 and 2003, Wisconsin roads and highways experienced 53 fatalities and more than 600 injuries in 631 cross-median crashes. Although most divided roadways were consistent with Wisconsin and American Association of State Highway and Transportation Officials (AASHTO) design standards, cross-median crashes were observed to be relatively independent of median width, average daily traffic (ADT), and lane width. The study was further expanded to determine median barrier warrants based on median widths [7]. Results were similar to the study in North Carolina and California,

in which many roadways with medians as wide as 70 ft (21 m) were applicable for median barrier installation.

A statistical analysis was conducted on cross-median crashes in the state of Minnesota to determine effectiveness of countermeasures as well as to validate or change the recommendations provided by AASHTO in the 2002 and 2006 Roadside Design Guides between 2005 and 2008. Cross-median events were tabulated based on site statistics and used to generate statistical models of median encroachment frequencies [8]. The encroachment frequencies were then applied to models of freeway and rural expressway roads in the Roadside Safety Analysis Program (RSAP), and used in a benefit-to-cost analysis of median barrier types. Because Minnesota did not tabulate cross-median events directly on crash report forms, statistical data selection methods were used to determine frequency of cross-median encroachments based on subsamples. Based on the data analysis, cross-median events were most common during the period between December and February, when snowfall and ice formation was prevalent on Minnesota roads and medians. By reducing friction, vehicles that departed the roadway were unable to come to a stop before entering opposing travel lanes, despite typically lower travel speeds. Probabilities of vehicle collision, median encroachment, cross-median encroachment, and ADT were factored into a simulation using the Monte Carlo technique and the model was recommended for evaluation against existing crash studies.

Cable barriers have long been recognized as an effective way of preventing vehicles from encountering side slopes which increase the risk of serious crashes, as well as embankments and separating traffic on high-speed facilities. Cash data analysis has indicated that cable barriers provide the highest overall level of safety when compared to concrete safety shapes and steel beam guardrails [9-10]. Further, study of guardrail performance on slopes indicated that cable barriers can perform effectively when installed on slopes as steep as 5:1 [11], while metal beam

guardrails did not demonstrate crashworthy performance on 6:1 slopes. Finally, cable barriers were the least expensive barrier option for use in medians of high-speed freeways. In view of the positive safety performance, capability of performing when installed on sloping medians, and low construction costs, it was not surprising that many highway agencies in the U.S. have decided to implement cable barriers whenever it was necessary to prevent cross-median crashes through depressed median ditches. As of today, the DOTs in more than 40 states have adopted this policy, and many of them have installed more than 100 miles of barrier. Industry experts have begun to predict that the installed base of cable median barriers in the U.S. will more than double over the next 7 to 10 years.

Even though cable median barrier has compiled a positive performance record, the high number of crashes that occur in narrow medians on high-speed, high-volume freeways still produces significant numbers of serious injury and fatal crashes involving cable barrier. A study of more than 5,000 cable barrier crashes over a two-year period found 12 fatal and 25 serious injury crashes [12]. Surprisingly, only half of the fatal crashes involved vehicles penetrating through the barrier and entering opposing traffic lanes. The remaining fatalities appeared to be related to impact with the cable barrier itself. Although the rate of six fatal crashes per year represented a 90% reduction in fatal crash rates when compared to the time prior to installation of cable barrier, these six fatal crashes per year would indicate that as many as 250 fatal crashes occur annually when extrapolated to data nationwide.

Further, if industry experts are correct and the installed base of cable barrier doubles over the next decade, up to 500 motorists could die annually during cable median barrier crashes within 10 short years. If this situation is to be avoided, improved cable barrier designs and deployment guidelines must be developed while construction of the barriers is still ongoing. The

first step in developing better barrier designs and placement guidelines is to discover the primary causes associated with cable barrier crashes that produce fatalities and serious injuries.

In recognition of the critical need for a better understanding of the causes of cable barrier penetrations and serious injury and fatal crashes, the Mid-America Transportation Center (MATC), in collaboration with Safence Incorporated, funded the study described herein. The goal of this study was to take the first step toward improving cable median barrier performance by determining the factors, such as impact conditions, vehicle type, median slope, and barrier placement, which tend to produce cable barrier penetrations and serious injury and fatal crashes. Safence, Mid-America Transportation Center, and the Midwest Roadside Safety Facility expect to utilize the findings from this study to develop better barrier designs and prepare guidelines for barrier implementation that can significantly reduce serious injury and fatal crash rates involving cable median barrier.

3 STATE BARRIER INSTALLATION GUIDELINES

3.1 Summary of Barrier Installation Practice by State

Each state surveyed in this study indicated guidelines by which cable median barriers were to be installed in the states. While all current state design standards are reflective of the state-of-the-art with respect to cable median barrier placement in divided medians to mitigate barrier underride, override, and rollover frequency, some historical systems were constructed prior to this important guidance. Those systems may not reflect the standards identified in this chapter.

The information presented in this report is accurate and current to the best knowledge of the reporting authors. However, state design and installation guidelines available from state DOTs should be consulted for the most up-to-date, accurate, and detailed design standards available. This guide is not intended for use as a reference manual. It is intended to summarize the current practices of states for overall comparison.

The Iowa DOT currently requires cable median barriers to be placed 12 ft (3.7 m) from the edge of the travel way. Iowa required that on narrow ditches approximately 30 ft (9.1 m) or less, ditches be filled and slopes graded to 8:1 in front of the cable median barrier. The barrier is then installed adjacent to the median centerline. On wider medians, the Iowa DOT required that the approach slope to the barrier from the adjacent travel lanes be graded to 8:1, and the slope behind the barrier be tapered to match the existing slope with a slope shallower than or equal to 4:1. The grading in front of the cable median barrier was 10 ft (3.0 m) or wider.

The Missouri DOT permitted the use of high-tension cable median barriers on 4:1 slopes when those systems were eligible for installation based on acceptable crash testing results. Low-tension cable median barriers on steep slopes were eligible for replacement, and new or existing low-tension, 3-cable median barriers may only be installed on 6:1 or flatter slopes. Barriers were

installed on slopes based on median widths. For medians greater than 30 ft (9.1 m) wide, barriers could be installed at least 8 ft (2.4 m) from the edge of the travel way and up to 4 ft (1.2 m) down the approach slope. For medians less than 30 ft (9.1 m) wide, median barriers were placed within 1 ft (0.3 m) of the center of the ditch. Vegetative barriers were located up to 2 ft (0.6 m) behind the barrier system.

The Ohio DOT required barrier installation a minimum of 12 ft (3.7 m) from the travel way and 8 ft (2.4 m) from the center of the ditch, on 6:1 or flatter V-ditches. Cable median barrier could also be placed adjacent to the shoulder if the shoulder was sufficiently wide enough; shoulder placement was required on slopes steeper than 4:1. The maximum slope behind the barrier relative to adjacent travel lanes was 4:1. The maximum post spacing permitted was 15 ft (4.6 m).

The Oklahoma DOT permitted cable median barrier installation on 6:1 V-ditches or flatter. Generally, cable median barriers were only placed on medians which permitted at least 8 ft (2.4 m) on both sides of the median barrier without encroaching into adjacent travel lanes, but there is consideration for narrower medians on the grounds that small encroachments into opposing travel lanes are more desirable than cross-median crashes. Barriers are not permitted between 1 ft (0.3 m) and 8 ft (2.4 m) of the center of the ditch.

The Oregon DOT permitted limited installations in 4:1 V-ditches where crash testing indicated acceptable performance. The Oregon DOT prohibited the use of cable median barriers in median V-ditches between 1 and 8 ft (0.3 and 2.4 m) from the center of the ditch. Barriers were always recommended to be placed as far from the travel lanes as could be practically installed. Median slopes were generally clear of debris, smooth, and frequently seeded with grass.

The Texas DOT also recommended barrier placement as far from the roadway as practical. Barriers could be placed within 1 ft (0.3 m) of the center of the median, or more than 8 ft (2.4 m) from the center of the median, and as far from the travel lanes as practicable. Barriers were not permitted for installation in medians less than 24 ft (7.3 m) wide. Also, slopes in front of and behind the barrier were not permitted to be steeper than 6:1. On tight curves with radii of 650 to 2,500 ft (198 to 762 m), post spacing was required to be 6 ft – 8 in. (2.0 m) on center. For radii between 2,501 and 5,500 ft (762 to 1,676 m), cable barrier post spacing was 10 ft (3.0 m) on center, and for larger radii standard post spacing was utilized.

The Utah DOT required that cable median barriers be placed 1 ft (0.3 m) from the ditch center, 8 ft (2.4 m) from the ditch center, or between 8 and 16 ft (2.4 and 4.9 m) from one edge of the travel way. The Utah DOT complied with studies which indicated that the best capture behavior and rollover management indicated that the optimum placement was between 8 and 15 ft (2.4 and 4.6 m) from the edge of the road. In stepped medians, offsets were usually made with respect to the higher-elevated roadway. Cable median barriers were not used on medians with slopes steeper than 6:1.

The Washington DOT required that cable median barriers be located 0 to 1 ft (0 to 0.3 m) from the center of the ditch, beyond 8 ft (2.4 m) from the center of the ditch, or near roadway shoulders. Barriers located at ditch shoulders were required to have a minimum clearance of 8 ft (2.4 m) from the roadway, and barriers were not permitted between 1 ft and 8 ft (0.3 m and 2.4 m) of the center of the ditch for slopes between 10:1 and 6:1. Cable median barriers could be installed on approach slopes of 6:1 or flatter, but required a minimum of 1 ft (0.3 m) lateral offset from the slope break point of a slope steeper than 6:1. Cable median barriers were also required to have a minimum top cable height of 35 in. (889 mm) and a bottom cable height not greater

than 19 in. (483 mm). In general, cable barriers were always recommended to be located as far from the roadway as practicable.

The Wisconsin DOT required that cable median barriers be placed 4 ft (1.2 m) from the slope break point in 4:1 V-ditches, although frequently cable median barrier was not selected for such steep terrain. At the time of this report, cable median barrier was limited to installations on 6:1 V-ditches, and when cable median barrier was necessary on roadways with 4:1 V-ditches, typically two installations of cable median barrier were used adjacent to each shoulder. On 6:1 V-ditches, cable median barriers were located a minimum of 8 ft (2.4 m) from the center of the ditch, due to drainage and erosion concerns and to reduce risk of underride or override from vehicles traversing through the center of the median.

3.2 Reference Definitions

Unless defined explicitly, the following definitions were utilized:

1. Shoulder

The shoulder was defined as the relatively flat extension of the roadway outside of the travel lanes. Shoulders could be paved or unpaved. The edge of the shoulder was defined as a transition in slopes from the roadway to the median. If no transition was present, the median was described as “flat” and the entire median was treated as if the two roadway shoulders intersected.

2. Approach Slope

Approach slopes were defined as the first slopes encountered by errant vehicles departing the roadway into the median after traversing the shoulder. In stepped medians in which there was only one median slope, the entire slope was considered an approach slope. Vehicle travel direction was always consulted in crash data analysis to determine the correct approach slope and vertical grade encountered. The barrier was considered to be on the approach slope if the barrier was more than 3 ft (0.9 m) from the edge of the shoulder.

3. Center of Ditch

The center of ditch referred to the area of the ditch spanning between 4 ft (1.2 m) on either side of the ditch slope transition between the approach and back slopes. This definition does not necessarily refer to the physical centerline of the V-ditch. For ditches with flat centers more than 4 ft (1.2 m) wide and less than 15% of the ditch width, the entire flat center of the ditch was considered the ditch center.

4. Back Slope

The back slope, if present, was the slope encountered by a vehicle after crossing the center of the V-ditch. Back slopes were not relevant on all crashes involving cable median barrier redirection when the barrier was installed on traffic-side shoulders, approach slopes, or near the center of the ditch. In sawtooth medians in which back slopes had different slope rates than the approach slope, distinctions were made between each slope rate. As with approach slopes, travel direction of the errant vehicle was consulted when identifying which slope was an approach slope and which slope was a back slope. A barrier was considered to be on the back slope if the barrier was more than 3 ft (0.9 m) from the opposite-side shoulder.

5. Penetration

A barrier penetration was defined as a crash in which the impacting vehicle traversed completely from one side of the barrier to the other side, such that no cables were in advantageous positions to redirect the vehicle if it continued to move toward opposite travel lanes. A potential penetration was similar, except that the vehicle came to a stop before completely passing from one side of the cable median barrier to the other.

6. Rollover

A rollover was defined as a crash in which the impacting vehicle made a minimum of one quarter-revolution about the longitudinal axis.

7. Failure

Cable median barriers are generally designed to safely redirect or capture vehicles with controlled lateral displacement of the barrier. As such, barrier failures were defined as crashes in which any of the following events occurred: penetration, rollover, or serious injury or fatality of an occupant in a vehicle striking the cable median barrier.

However, a barrier failure does not necessarily indicate a poor crash result. For example, a barrier containment failure consisting of a penetration may result in property damage only to the impacting vehicle and potentially one or two cable median barrier posts. If the occupant of the impacting vehicle is unharmed, the barrier containment failure would not be considered hazardous. Furthermore, if the vehicle which was involved in a penetration event did not penetrate into opposing travel lanes and the crash injury level was not severe, the barrier may have satisfactorily prevented a cross-median crash; in this instance, the barrier containment failure still resulted in acceptable overall performance and the crash outcome was positive.

Though the nature of cross-median crash prevention can be speculative, history has shown that even with penetration rates as high as 10% and rollover frequency as high as 8% of all crashes, overall median severity on many roadways improved after a cable median barrier was installed. This was particularly true if a relatively high rate of fatalities was already present due to cross-median crashes. Neither penetration nor rollover containment failures indicate that the barrier is unsafe, but instead refer only to the breach in containment experienced by the impacting vehicle.

Barrier systems were located consistent with the state design standards. The only exceptions to this identification were with respect to systems installed before newer design guidelines became available between 2004 and 2007. Such barrier systems were analyzed and included in the results because of potential significance to the outcome of this report.

4 SUMMARY OF CABLE BARRIER CRASHES

4.1 Description of Study

A total of 12 states responded to a survey request for crash data regarding cable median barrier crashes. A total of more than 25,000 crashes were received which documented periods between 1996 and 2010. In addition, approximately 6,000 crashes with sufficient information were extracted for further evaluation. The state DOTs which provided data for this study were: Missouri, North Carolina, Ohio, Oklahoma, Washington, Iowa, Illinois, Texas, Oregon, Utah, Kentucky, and Wisconsin.

Between 2007 and 2009, 7,093 cable median barrier crashes were reported in Missouri, and of those crashes, 174 involved serious injuries or fatalities. Hence, the combined serious injury and fatal crash rate for cable barriers in Missouri was found to be 2.5%. This finding was consistent with prior crash studies of cable barriers that indicated low crash severities for cable barriers when compared to other types of barriers. For example, the combined serious and fatal injury rates for guardrail and bridge rail crashes in Kansas were 4.9% and 3.6% respectively [14].

Crash reports were obtained for all 174 crashes involving serious or fatal injuries in the Missouri database, of which 169 of the crash reports contained detailed drawings of the crash scene, including measurements of vehicle position near points of departure and impact and vehicle tire marks laid down as the vehicle approached the barrier. A careful examination of these crashes revealed that the cable barrier significantly contributed to occupant injury in 128 of the crashes. The remaining 46 crashes involved other mechanisms for occupant injury, including vehicle rollover prior to the barrier impact, impacts with another vehicle before leaving the travelway, and acute health problems of the driver and occupants unrelated to the crash. When crashes involving injuries produced prior to striking a barrier are eliminated from the database,

the combined serious and fatal injury crash rate was reduced to 1.8%. An additional set of 22 crashes in North Carolina were provided and had exact scene measurements, photographs of the vehicle and system, median slope measurements, median widths, and vehicle information. The 22 crashes consisted only of penetration crashes; this dataset was not a random sample.

Using reported lengths and widths measured by investigating officers at points of vehicle departure from the road and at the point of impact with the cable median barrier, crash scene diagrams were scaled to account for varying longitudinal and lateral compression to fit the boundaries of the scene diagram, which generated approximate, dimensionally representative crash scene drawings. Then, approximate scaled crash scenes were used to generate vehicle trajectory information up to the point of impact with the barrier system. Trajectory data included the vehicle CG trajectory angle, sideslip angle, and the angle between the vehicle's longitudinal axis and the barrier. This information was used to build a database of crash impact conditions to evaluate vehicle/barrier interaction.

An additional 890 cases were extracted from a crash database in the state of Ohio, whose locations were observable using the Google Street View application. Slope data digitized from topographical surveying was used to obtain median geometries at each crash location, which was located using a combination of mile markers, latitudes and longitudes, feature references, and information from indicative scene diagram representations. As with the Missouri database, unrelated crashes were excluded from the analysis. Photographs of the crash scene and vehicle were requested for all crashes in which photographs were taken of the scene, and those photos were released through the Ohio Department of Public Safety, with additional cooperation from the Ohio State Patrol.

A tabulated database of crashes was obtained from the Oklahoma DOT, including crash results, roadway locations, and barrier types that were struck. Crash reports were not available

for the crashes listed, and vehicle year, make, and model were not available for release under Oklahoma law. Due to limited funding, the purchase of crash report copies was not pursued.

A tabulated database of cable median barrier crashes was received from the state of Washington and covering a period between 1996 and 2008, with an additional tabulated list of model, make, and year of the vehicles involved in cable barrier crashes. Crash reports for serious injury and fatal crashes in the state were also provided. The database included information regarding the crash result and the manner of collision, along with an extensive investigation of injury tabulation. As with Oklahoma, the majority of crashes did not have a scene diagram or a narrative available to definitively identify crash injury causation, mechanisms of barrier containment failures, and potential data overlap. Nonetheless the database was useful for evaluating crash statistics, overall barrier performance, and installation practices.

The Iowa DOT provided a tabulated database of cable median barrier crashes and results between 2006 and 2009, along with scene diagrams and crash narratives. Although precise scene diagram measurements were not available, make, model, and year of vehicles striking the cable median barrier were provided. Precise geographical locational measurements were provided for each crash to identify the exact location of the crash site for further investigation.

The Illinois DOT provided a crash database to evaluate propensities for cross-median collisions, as well as a tabulated list of cable barrier crashes between 2005 and 2008 in the state of Illinois. Scene diagrams and narratives were not provided, and no median information was available. However, precise geographical location measurements were also available and the crash sites were located, allowing precise determination of barrier usage at each site.

The Texas DOT provided a large block of crash data regarding all crashes, not only cable median barrier crashes on divided median roadways between 2003 and 2009. Unfortunately Texas law, which is similar to Oklahoma, does not permit the free exchange of sensitive crash

data such as scene diagrams, crash narratives, and occupant information. Because the crash data could not be used to determine crash causation or object struck, the Texas data was limited in scope to crash statistics for only broad evaluations.

The Oregon DOT provided a crash summary database for cable median barrier crashes in Oregon through 2007. This information included crash severity and relative risk based on the total number of crashes, as well as crash statistics measured by DOT researchers.

Similarly, the Kentucky Department of Public Safety (DPS) provided lists of crash reports available for sorting. However, since this information was received later in the analysis, the crash results were only used for generating statistical comparisons.

The Utah DOT provided a database of scene diagrams, crash narratives, impacting vehicle makes, models, and years, road segment traffic volumes, and crash statistics. Photos and annotated scene diagrams with survey measurements were available for purchase through the Department of Public Safety, but the available funding for the project prohibited this extra expense. Utah also provided information regarding barrier type for installations throughout the state.

The Wisconsin DOT provided crash reports, scene diagrams, and a webcam video of a single cable barrier penetration event in the state of Wisconsin. Each cable barrier crash was located using a geographical state surveying tool, and locations of each crash were identified. Included in the crash reports were vehicle make, model, and year.

It is possible that a number of critical injury and fatal crashes involving cable median barriers were incorrectly coded and therefore excluded from the database. However, prior experience with crash reports associated with barrier crashes would indicate that it is not common that a police officer fails to indicate the barrier was struck for a crash involving serious injuries and fatalities. Therefore, it was assumed that the number of crashes missing from the

database was relatively low. Further, even if a significant number of unreported severe crashes do occur, there is no reason to believe that omitted cases would have a bias in any characteristic other than injury severity. Because police officers are likely to spend more time investigating serious injury and fatal crashes, the bias would reduce the risk of case omission as the severity increased.

4.2 Cable Barrier Impacts

In each state, cable barrier crashes were examined to determine if the barrier failed to adequately capture or redirect the vehicle without subjecting occupants to serious injury or fatality. For the purpose of analysis, three categories were created: penetration crashes, rollover crashes, and severe injury or fatality (A+K) crashes.

Severe A+K crashes were defined as crashes when at least one occupant of the vehicle impacting the cable barrier experienced a severe or disabling injury or fatality. An effort was made to exclude crashes in which the fatality or severe injury was not caused at least in part by the reaction of the cable barrier. Cable barrier crashes in which the vehicle was not redirected and passed from the impact side to non-impact side of the barrier were classified as a penetration crashes. Crashes in which the vehicle either protruded under, between, or over the top of the barrier but came to rest before all four tires passed to the non-impact side were classified as potential penetrations, since repeated crashes with the same conditions would likely cause at least one penetration to occur. Rollover crashes required that vehicles made at least a one-quarter revolution about the longitudinal axis before coming to rest. Rollover crashes in which the vehicle tripped before impacting the barrier impact or in which the rollover was unrelated to cable barrier performance were excluded.

The crash set was further segregated in the event that a rollover occurred contingently with a penetration. The overlapping data set was segregated into mutually exclusive causative

factors, using scene diagrams, crash narratives, vehicles, and median information to determine which factor was the predominant or causative reaction in penetration and rollover crashes. If a vehicle penetrated through the barrier before rolling over on the median back slope, opposing travel lanes, or other post-penetration impact location, the major causative factor was determined to be a penetration. However, if it was determined that the vehicle overturning caused or contributed to the vehicle penetrating through or over the top of the barrier, the major causative factor was identified to be a rollover. Separate efforts were made to determine the injury causes of A+K crashes due to contact with a barrier element, rollover, ejection, or other factors.

4.2.1 Weather and Road Conditions

Cable barrier crashes tabulated from each state DOT were investigated to evaluate the frequency of weather-related crashes compared to annual numbers of days with rainfall and snowfall in each state. The frequency of adverse weather effects in surveyed states are shown in Tables 1 and 2. Some states were characterized by a wide variation in regional annual snowfall and rainfall, based on data by NOAA National Climate Data Center for annual precipitation.

The standard deviations in average days with snowfall were as large as the average number of days with snowfall for some states. In some locations, the number of days with snow or rain could vary from one region to another by a factor of 10 [15]. Conversely, states in the lower Midwest and coastal regions did not have large variations in days with rainfall or snowfall, such as Missouri, North Carolina, and Washington.

Oklahoma averaged only 61 days with minimum rainfall of 0.01 in. (0.25 mm) and three days with minimum snowfall of 0.1 in. (2.5 mm). States with the lowest relative deviation based on the norm were located in the Midwest, including Ohio, Illinois, Missouri, and Iowa, with the one notable exception of Washington.

Table 1. Average Number of Days with Rainfall in Select Surveyed States

| State | Average Number of Days with Minimum Rainfall of | | | Frequency of Days with Minimum Rainfall of | | | Average Deviation |
|----------------|---|----------------|-----------------|--|------------------|------------------|-------------------|
| | 0.01 in. (0.3 mm) | 0.1 in. (3 mm) | 0.5 in. (13 mm) | 0.01 in. (2.5 mm) | 0.1 in. (2.5 mm) | 0.5 in. (2.5 mm) | |
| Illinois | 94.5 | 64.1 | 26.2 | 25.9% | 17.5% | 7.2% | 10.2% |
| Iowa | 82.2 | 53.1 | 21.4 | 22.5% | 14.5% | 5.9% | 11.1% |
| Missouri | 89.6 | 63.8 | 28.5 | 24.6% | 17.5% | 7.8% | 10.4% |
| North Carolina | 115.5 | 79.1 | 33.1 | 31.6% | 21.7% | 9.1% | 11.9% |
| Ohio | 118.7 | 75.4 | 25.5 | 32.5% | 20.6% | 7.0% | 10.4% |
| Oklahoma | 61.4 | 44.6 | 24.2 | 16.8% | 12.2% | 6.6% | 21.6% |
| Utah | 55.0 | 25.1 | 4.9 | 15.1% | 6.9% | 1.3% | 57.7% |
| Washington | 104.9 | 62.1 | 19.9 | 28.7% | 17.0% | 5.5% | 8.9% |
| Wisconsin | 123.3 | 75.4 | 23.3 | 33.8% | 20.7% | 6.4% | 66.0% |

Table 2. Average Number of Days with Snowfall in Select Surveyed States

| State | Average Number of Days with Minimum Snowfall of | | | Frequency of Days with Minimum Snowfall of | | | Average Deviation |
|----------------|---|-----------------|------------------|--|------------------|------------------|-------------------|
| | 0.1 in. (3 mm) | 1.0 in. (25 mm) | 5.0 in. (127 mm) | 0.01 in. (2.5 mm) | 0.1 in. (2.5 mm) | 0.5 in. (2.5 mm) | |
| Illinois | 11.9 | 6.9 | 0.8 | 3.3% | 1.9% | 0.2% | 47.6% |
| Iowa | 16.9 | 11.0 | 1.3 | 4.6% | 3.0% | 0.4% | 22.6% |
| Missouri | 6.5 | 4.2 | 0.5 | 1.8% | 1.2% | 0.1% | 42.5% |
| North Carolina | 2.7 | 1.9 | 0.4 | 0.7% | 0.5% | 0.1% | 172.2% |
| Ohio | 17.9 | 9.4 | 0.8 | 4.9% | 2.6% | 0.2% | 68.9% |
| Oklahoma | 3.0 | 2.1 | 0.3 | 0.8% | 0.6% | 0.1% | 75.2% |
| Utah | 19.2 | 15.5 | 3.0 | 5.3% | 4.3% | 0.8% | 113.6% |
| Washington | 27.2 | 17.2 | 2.1 | 7.5% | 4.7% | 0.6% | 39.3% |
| Wisconsin | 11.8 | 8.4 | 1.9 | 3.2% | 2.3% | 0.5% | 195.0% |

Monthly and annual precipitation was also tabulated by the states participating in the research study, as shown in Tables 3 and 4. An approximate distribution of cable median barriers located on an NOAA precipitation map is shown in Figure 1. Since most states were surveyed in the central plains to Midwest region, the annual yearly precipitation is similar for Iowa, Illinois, Missouri, and Wisconsin, though Wisconsin had locally larger rain and snow accumulation due to proximity to Lakes Superior and Michigan. However, because Wisconsin is west and south of the Great Lakes, the additional precipitation is highly localized, with as much as 140 in. (3,556 mm) of snow falling annually at the southern-central portion of Lake Superior and 40 to 50 in. (1,016 to 1,270 mm) falling in most of the remainder of the state. Most cable median barriers in Wisconsin were located around Fon du Lac, Wisconsin.

Whereas the average precipitation in Oklahoma was relatively large, most of the cable median barriers were located around the Norman and Oklahoma City areas. Rainfall in these regions came less frequently and with lower accumulation than in the eastern part of the state.

Table 3. Average Monthly Precipitation in Select Surveyed States

| State | Average Monthly Precipitation, 50th Percentile (in.) | | | | | | | | | | | | |
|----------------|--|-----|-----|-----|-----|-----|-----|-----|-----|-----|-----|-----|--------|
| | Jan | Feb | Mar | Apr | May | Jun | Jul | Aug | Sep | Oct | Nov | Dec | Annual |
| Illinois | 1.8 | 1.9 | 2.6 | 3.4 | 4.4 | 3.8 | 3.6 | 3.2 | 2.7 | 2.7 | 3.2 | 2.3 | 35.7 |
| Iowa | 0.9 | 1.0 | 1.8 | 3.2 | 4.3 | 4.5 | 3.9 | 3.6 | 3.0 | 2.2 | 1.8 | 1.2 | 31.3 |
| Missouri | 1.8 | 2.0 | 2.9 | 3.8 | 4.8 | 4.2 | 3.7 | 3.3 | 3.3 | 3.1 | 3.2 | 2.4 | 38.7 |
| North Carolina | 3.8 | 3.5 | 4.1 | 3.4 | 3.6 | 4.1 | 4.7 | 4.6 | 3.9 | 3.2 | 3.4 | 3.6 | 45.8 |
| Ohio | 2.3 | 2.1 | 2.9 | 3.5 | 4.3 | 3.9 | 3.8 | 3.2 | 2.8 | 2.6 | 3.0 | 2.8 | 37.1 |
| Oklahoma | 1.5 | 1.6 | 2.8 | 3.1 | 4.6 | 4.2 | 2.6 | 2.6 | 3.2 | 2.9 | 2.2 | 1.8 | 33.0 |
| Utah | 1.0 | 1.1 | 1.3 | 1.2 | 1.1 | 0.6 | 0.7 | 0.9 | 1.0 | 1.3 | 1.0 | 1.0 | 12.2 |
| Washington | 5.9 | 3.7 | 3.9 | 2.9 | 2.3 | 1.8 | 0.7 | 0.7 | 1.5 | 3.6 | 6.2 | 5.6 | 38.9 |
| Wisconsin | 1.0 | 1.0 | 1.7 | 2.8 | 3.4 | 3.8 | 3.7 | 3.7 | 3.3 | 2.6 | 1.9 | 1.3 | 30.1 |

Table 4. Average Monthly Snowfall in Select Surveyed States

| State | Average Monthly Snowfall, 50th Percentile (in.) | | | | | | | | | | | | |
|----------------|---|-----|-----|-----|-----|-----|-----|-----|-----|-----|-----|-----|--------|
| | Jan | Feb | Mar | Apr | May | Jun | Jul | Aug | Sep | Oct | Nov | Dec | Annual |
| Illinois | 5.1 | 3.0 | 1.1 | 0.0 | 0.0 | 0.0 | 0.0 | 0.0 | 0.0 | 0.0 | 0.1 | 3.8 | 13.1 |
| Iowa | 6.7 | 5.6 | 3.5 | 0.2 | 0.0 | 0.0 | 0.0 | 0.0 | 0.0 | 0.0 | 1.3 | 6.5 | 23.7 |
| Missouri | 2.3 | 2.0 | 0.3 | 0.0 | 0.0 | 0.0 | 0.0 | 0.0 | 0.0 | 0.0 | 0.0 | 1.7 | 6.2 |
| North Carolina | 0.7 | 0.6 | 0.2 | 0.1 | 0.0 | 0.0 | 0.0 | 0.0 | 0.0 | 0.0 | 0.0 | 0.3 | 2.0 |
| Ohio | 7.0 | 4.3 | 2.9 | 0.1 | 0.0 | 0.0 | 0.0 | 0.0 | 0.0 | 0.0 | 0.5 | 4.3 | 19.1 |
| Oklahoma | 0.8 | 0.2 | 0.2 | 0.0 | 0.0 | 0.0 | 0.0 | 0.0 | 0.0 | 0.0 | 0.0 | 0.6 | 1.7 |
| Utah | 9.1 | 8.2 | 5.8 | 2.8 | 0.5 | 0.0 | 0.0 | 0.0 | 0.0 | 0.7 | 4.5 | 9.0 | 40.5 |
| Washington | 5.6 | 2.9 | 1.5 | 0.7 | 0.2 | 0.0 | 0.0 | 0.0 | 0.0 | 0.2 | 2.4 | 6.9 | 20.4 |
| Wisconsin | 10.6 | 8.7 | 7.0 | 1.3 | 0.0 | 0.0 | 0.0 | 0.0 | 0.0 | 0.1 | 3.0 | 9.8 | 40.6 |

Ohio’s annual precipitation was higher because of its close proximity to Lake Erie, which occasionally resulted in more than 5 in. (127 mm) of rain or 12 in. (305 mm) of snow within a span of a few days in some cable median barrier locations. In general, southern parts of the state recorded higher precipitation totals, due to contributions from gulf and coastal storm systems.

Besides Ohio, both Washington and North Carolina experienced higher cumulative precipitation than other states in this survey. Both Washington and North Carolina are coastal states which experience significant rainfall, without much snowfall in the areas around cable barrier locations. In contrast, Utah was largely dry, except for the I-15 corridor. However, the I-

15 corridor was also the site of much of the cable median barriers installed in Utah. A map of the precipitation of the continental United States, with approximate locations of selected cable median barriers which were examined, is shown in Figure 1.

Precipitation: Annual Climatology (1981-2010)

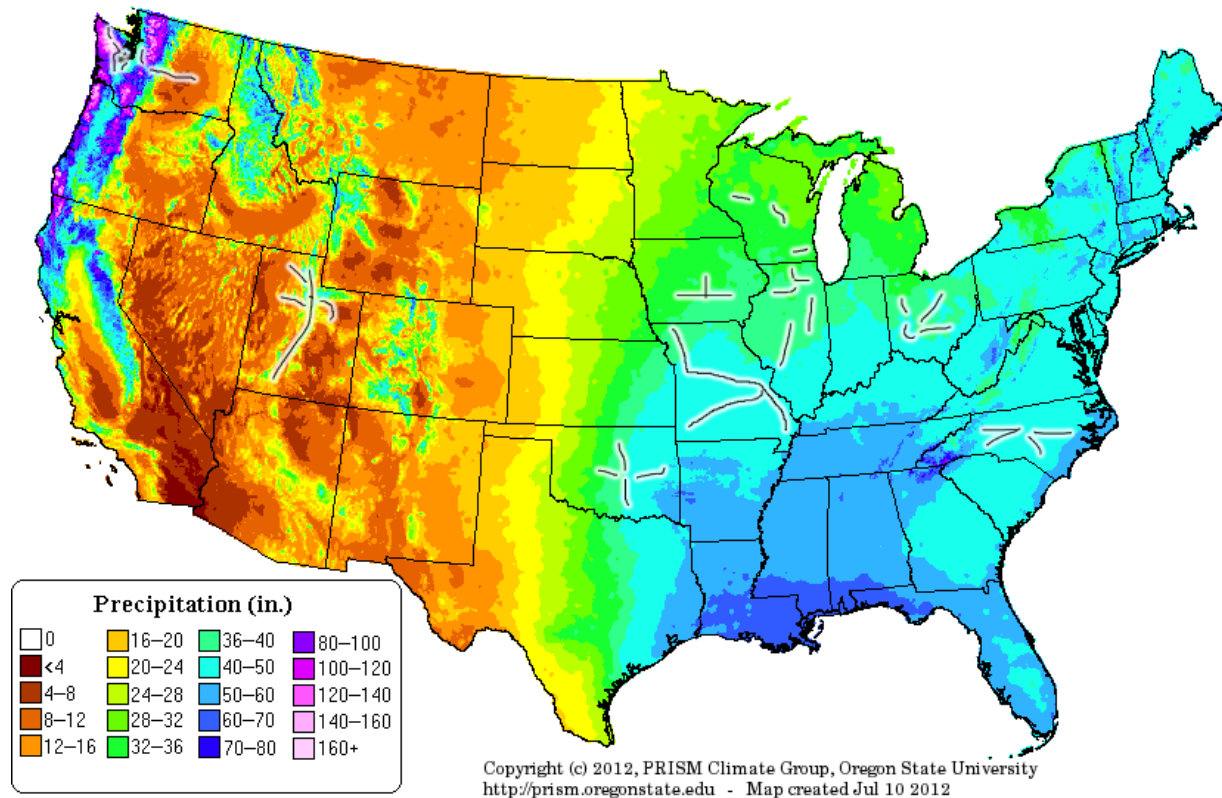

Figure 1. Selected Approximate Barrier Locations with Annual Precipitation Estimates [16]

Barrier performance was tabulated for each impact in the available database of crashes; however, crashes in which a penetration or rollover occurred were subjected to additional scrutiny to identify the cause of the poor barrier performance. The process of selection and causality used in this study is described in greater detail in Chapters 6 and 8.

Results of each state were segregated by weather conditions (i.e., snowing, raining), road conditions at the time of the crash (i.e., wet, snow-covered, slush), crash severity, type of cable barrier system that was struck, the date of crash, and the barrier's performance. The results are

tabulated in Tables 5 through 10. Primary barrier containment failures were identified and segregated by predominant weather and road conditions. By considering only primary barrier failures, secondary events such as penetration following rollover were excluded from the analysis. Primary barrier failure segregation also served the purpose of establishing mutually exclusive categories of penetration or rollover crashes; this was useful in determining what driving conditions were associated with the predominant cause of barrier containment failures.

Since some states had significant volumes of data and others had smaller data sets, a crash volume weighting factor was used to bias results toward states with more crashes when each state's crash results were averaged together. Weighting factors applied to determine the approximate average rate cable barrier containment failures consisted of an average of the aggregate percentage of failures in each state with the aggregate percentage of failures of all states. This process weighted data from states with large volumes of crash data, but still incorporated data from states with limited available crash databases to draw from. The average rate of vehicular penetration through the barrier was approximately 9.3% when penetrations were the primary barrier containment failure. In contrast, the composite average rate of vehicle rollover as a primary containment failure mechanism was approximately 5.1%. When considering the rates of actual vehicle rollover and penetration over the barrier and relaxing the mutually-exclusive primary failure mechanism restriction, the composite rate of penetrations and rollovers rose to approximately 9.9% and 8.1%, respectively.

Three key conclusions were drawn from the data:

(1) Dry, clear conditions were associated with the highest rates of penetration or rollover.

Rollover crash outcomes were more dependent on the prevailing weather conditions and road conditions than penetration crash outcomes. During adverse weather conditions or when roads were not dry and clear, penetration and rollover propensities

Table 5. Crash Result in States by Predominant Weather Condition

| Weather Condition at Time of Crash | Illinois | | Iowa | | Ohio | | Oklahoma | | Utah | | Washington | | Wisconsin | |
|------------------------------------|------------|-------------------------------------|------------|------------------------|------------|------------------------|-------------|--------------------------------------|------------|------------------------|-------------|------------------------|-----------|------------------------|
| | Crashes | Penetration ¹ / Rollover | Crashes | Penetration / Rollover | Crashes | Penetration / Rollover | Crashes | Cross-Median ² / Rollover | Crashes | Penetration / Rollover | Crashes | Penetration / Rollover | Crashes | Penetration / Rollover |
| No Adverse Effects | 150 | - / 8 | 60 | 4 / 1 | 404 | 30 / 46 | 1147 | 26 / 48 | 479 | 26 / 42 | 1105 | 139 / 94 | 44 | 7 / 4 |
| Rain | 48 | - / 0 | 10 | 1 / 0 | 164 | 10 / 3 | 415 | 7 / 6 | 43 | 2 / 1 | 290 | 45 / 7 | 3 | 0 / 0 |
| Snow or Sleet | 100 | - / 3 | 52 | 4 / 1 | 274 | 18 / 1 | 190 | 1 / 4 | 397 | 10 / 8 | 225 | 24 / 11 | 49 | 5 / 2 |
| Fog or Mist | 4 | - / 0 | 1 | 0 / 0 | 7 | 2 / 1 | 13 | 0 / 1 | 3 | 0 / 0 | 20 | 2 / 3 | 0 | 0 / 0 |
| Strong Crosswind | 2 | - / 0 | 3 | 0 / 0 | 0 | 0 / 0 | 4 | 0 / 1 | 3 | 0 / 0 | 1 | 0 / 0 | 0 | 0 / 0 |
| Unknown or Other | 1 | - / 0 | 0 | 0 / 0 | 9 | 2 / 2 | 11 | 0 / 0 | 2 | 0 / 0 | 6 | 0 / 0 | 1 | 0 / 0 |
| Total | 305 | - / 11 | 126 | 9 / 2 | 858 | 78 / 37 | 1780 | 34 / 60 | 927 | 38 / 51 | 1647 | 210 / 115 | 97 | 12 / 6 |

| Weather Condition at Time of Crash | Illinois | | Iowa | | Ohio | | Oklahoma | | Utah | | Washington | | Wisconsin | |
|------------------------------------|------------|-------------------------------------|------------|------------------------|------------|------------------------|-------------|--------------------------------------|------------|------------------------|-------------|------------------------|-----------|------------------------|
| | Crashes | Penetration ¹ / Rollover | Crashes | Penetration / Rollover | Crashes | Penetration / Rollover | Crashes | Cross-Median ² / Rollover | Crashes | Penetration / Rollover | Crashes | Penetration / Rollover | Crashes | Penetration / Rollover |
| No Adverse Effects | 150 | - / 5.3% | 60 | 6.7% / 1.7% | 404 | 11.4% / 7.4% | 1147 | 2.3% / 4.2% | 479 | 5.4% / 4.2% | 1105 | 12.6% / 8.5% | 44 | 15.9% / 9.1% |
| Rain | 48 | - / 0.0% | 10 | 10.0% / 0.0% | 164 | 6.1% / 1.8% | 415 | 1.7% / 1.4% | 43 | 4.7% / 2.3% | 290 | 15.5% / 2.4% | 3 | 0.0% / 0.0% |
| Snow or Sleet | 100 | - / 3.0% | 52 | 7.7% / 1.9% | 274 | 6.6% / 0.4% | 190 | 0.5% / 2.1% | 397 | 2.5% / 2.0% | 225 | 10.7% / 4.9% | 49 | 10.2% / 4.1% |
| Fog or Mist | 4 | - / - | 1 | - / - | 7 | 28.6% / 14.3% | 13 | - / 7.7% | 3 | - / - | 20 | 10.0% / 15.0% | 0 | - / - |
| Strong Crosswind | 2 | - / - | 3 | - / - | 0 | - / - | 4 | - / 25.0% | 3 | - / - | 1 | - / - | 0 | - / - |
| Unknown or Other | 1 | - / - | 0 | - / - | 9 | 22.2% / 22.2% | 11 | - / - | 2 | - / - | 6 | - / - | 1 | - / - |
| Total | 305 | - / 3.6% | 126 | 7.1% / 1.6% | 858 | 9.1% / 4.3% | 1780 | 1.9% / 3.4% | 927 | 4.1% / 5.5% | 1647 | 12.8% / 7.0% | 97 | 12.4% / 6.2% |

Table 6. Crash Result in States with Complete Data Sets by Predominant Weather Condition

| Crashes Penetrations | Ohio | | Utah | | Wisconsin | | Total | |
|-----------------------------|-------------|--------------------------|------------|--------------------------|-------------|--------------------------|------------|--------------------------|
| | Crashes | Penetrations / Rollovers | Crashes | Penetrations / Rollovers | Crashes | Penetrations / Rollovers | Crashes | Penetrations / Rollovers |
| 60 | 4 | 1 / 1 | 404 | 46 / 30 | 479 | 26 / 42 | 44 | 7 / 4 |
| 10 | 1 | 0 / 0 | 164 | 10 / 3 | 43 | 2 / 1 | 3 | 0 / 0 |
| 52 | 4 | 1 / 1 | 274 | 18 / 1 | 397 | 10 / 8 | 49 | 5 / 2 |
| 1 | 0 | 0 / 0 | 7 | 2 / 1 | 3 | 0 / 0 | 0 | 0 / 0 |
| 3 | 0 | 0 / 0 | 0 | 0 / 0 | 3 | 0 / 0 | 0 | 0 / 0 |
| 0 | 0 | 0 / 0 | 9 | 2 / 2 | 2 | 0 / 0 | 1 | 0 / 0 |
| 126 | 9 | 2 / 2 | 858 | 78 / 37 | 927 | 38 / 51 | 97 | 12 / 6 |
| Crashes Penetrations | 60 | 1.7% | 404 | 7.4% | 479 | 8.8% | 44 | 9.1% |
| Rollovers | 1 | 1.6% | 30 | 4.3% | 30 | 5.5% | 4 | 4.8% |
| Total | 987 | 8.4% | 220 | 5.9% | 772 | 4.8% | 11 | 18.2% |
| Crashes Penetrations | 987 | 8.4% | 220 | 5.9% | 772 | 4.8% | 11 | 18.2% |
| Rollovers | 77 | 4.1% | 12 | 1.6% | 1 | 9.1% | 2 | 6.2% |
| Total | 2008 | 6.2% | 137 | 9.6% | 2008 | 6.2% | 137 | 9.6% |

Table 7. Crash Result in States by Predominant Road Condition

| Crashes Penetrations ¹ Rollovers | Illinois | | | Iowa | | | Ohio | | | Oklahoma | | | Utah | | | Washington | | | Wisconsin | | |
|---|--------------|--------------|-------------|--------------|--------------|-------------|--------------|--------------|-------------|---------------------------|---------------------------|-------------|--------------|--------------|-------------|--------------|--------------|--------------|--------------|--------------|-------------|
| | Crashes | Penetrations | Rollovers | Crashes | Penetrations | Rollovers | Crashes | Penetrations | Rollovers | Crashes | Cross-Medium ² | Rollovers | Crashes | Penetrations | Rollovers | Crashes | Penetrations | Rollovers | Crashes | Penetrations | Rollovers |
| 127 | 8 | 44 | 2 | 333 | 40 | 30 | 1575 | 24 | 56 | 364 | 21 | 35 | 888 | 115 | 79 | 26 | 5 | 1 | 26 | 5 | 1 |
| 63 | 1 | 15 | 0 | 260 | 18 | 5 | 39 | 9 | 0 | 99 | 5 | 3 | 398 | 57 | 12 | 7 | 1 | 0 | 7 | 1 | 0 |
| 113 | 2 | 67 | 0 | 261 | 20 | 2 | 164 | 1 | 4 | 457 | 12 | 13 | 344 | 38 | 23 | 63 | 6 | 5 | 63 | 6 | 5 |
| 2 | 0 | 0 | 0 | 4 | 0 | 0 | 2 | 0 | 0 | 7 | 0 | 0 | 17 | 0 | 1 | 1 | 0 | 0 | 1 | 0 | 0 |
| 305 | 0 | 126 | 9 | 858 | 78 | 37 | 1780 | 34 | 60 | 927 | 38 | 51 | 1647 | 210 | 115 | 97 | 12 | 12 | 97 | 12 | 6 |
| | 0.0% | 3.6% | 1.6% | 8.8% | 9.1% | 4.3% | 17.8% | 1.9% | 3.4% | 9.2% | 4.1% | 5.5% | 16.4% | 12.8% | 7.0% | 7.0% | 12.4% | 12.4% | 9.7% | 12.4% | 6.2% |
| Crashes Penetrations ¹ Rollovers | Illinois | | | Iowa | | | Ohio | | | Oklahoma | | | Utah | | | Washington | | | Wisconsin | | |
| Crashes | Penetrations | Rollovers | Crashes | Penetrations | Rollovers | Crashes | Penetrations | Rollovers | Crashes | Cross-Medium ² | Rollovers | Crashes | Penetrations | Rollovers | Crashes | Penetrations | Rollovers | Crashes | Penetrations | Rollovers | |
| 127 | 6.3% | 44 | 9.1% | 333 | 12.0% | 30 | 1575 | 1.5% | 3.6% | 364 | 5.8% | 35 | 888 | 13.0% | 79 | 26 | 19.2% | 26 | 19.2% | 3.8% | |
| 63 | 1.6% | 15 | 13.3% | 260 | 6.9% | 1.9% | 39 | 23.1% | - | 99 | 5.1% | 3.0% | 398 | 14.3% | 57 | 7 | 14.3% | 7 | 14.3% | - | |
| 113 | 1.8% | 67 | 4.5% | 261 | 7.7% | 0.8% | 164 | 0.6% | 2.4% | 457 | 2.6% | 2.8% | 344 | 11.0% | 38 | 63 | 9.5% | 63 | 9.5% | 7.9% | |
| 2 | - | 0 | - | 4 | - | - | 2 | - | - | 7 | - | - | 17 | - | 1 | 1 | - | 1 | - | - | |
| 305 | 0.0% | 126 | 7.1% | 858 | 9.1% | 4.3% | 1780 | 1.9% | 3.4% | 927 | 4.1% | 5.5% | 1647 | 12.8% | 7.0% | 9.7% | 12.4% | 9.7% | 12.4% | 6.2% | |

Table 8. Crash Result in States with Complete Data Sets by Predominant Road Condition

| Road Conditions at Time of Crash | Iowa | | | Ohio | | | Utah | | | Wisconsin | | | Total | | |
|-------------------------------------|--------------|--------------|-------------|--------------|--------------|-------------|--------------|--------------|-------------|--------------|--------------|-------------|--------------|--------------|-------------|
| | Crashes | Penetrations | Rollovers | Crashes | Penetrations | Rollovers | Crashes | Penetrations | Rollovers | Crashes | Penetrations | Rollovers | Crashes | Penetrations | Rollovers |
| No Adverse Effects | 44 | 4 | 2 | 333 | 40 | 30 | 364 | 21 | 35 | 26 | 5 | 1 | 767 | 70 | 68 |
| Wet or Pooling Water | 15 | 2 | 0 | 260 | 18 | 5 | 99 | 5 | 3 | 7 | 1 | 0 | 381 | 26 | 8 |
| Snow, Slush, or Ice | 67 | 3 | 0 | 261 | 20 | 2 | 457 | 12 | 13 | 63 | 6 | 5 | 848 | 41 | 20 |
| Unknown or Other | 0 | 0 | 0 | 4 | 0 | 0 | 7 | 0 | 0 | 1 | 0 | 0 | 12 | 0 | 0 |
| Total | 126 | 9 | 2 | 858 | 78 | 37 | 927 | 38 | 51 | 97 | 12 | 6 | 2008 | 137 | 96 |
| | | 7.1% | 1.6% | 8.8% | 9.1% | 4.3% | 9.2% | 4.1% | 5.5% | 4.1% | 12.4% | 6.2% | 20.0% | 6.2% | 4.8% |
| Road Conditions at Time of Crash | Iowa | | | Ohio | | | Utah | | | Wisconsin | | | Total | | |
| Crashes | Penetrations | Rollovers | Crashes | Penetrations | Rollovers | Crashes | Penetrations | Rollovers | Crashes | Penetrations | Rollovers | Crashes | Penetrations | Rollovers | |
| No Adverse Effects | 44 | 9.1% | 4.5% | 333 | 12.0% | 9.0% | 364 | 5.8% | 9.6% | 26 | 19.2% | 3.8% | 767 | 9.1% | 8.9% |
| Wet or Pooling Water | 15 | 13.3% | - | 260 | 6.9% | 1.9% | 99 | 5.1% | 3.0% | 7 | 14.3% | - | 381 | 6.8% | 2.1% |
| Snow, Slush, or Ice | 67 | 4.5% | - | 261 | 7.7% | 0.8% | 457 | 2.6% | 2.8% | 63 | 9.5% | 7.9% | 848 | 4.8% | 2.4% |
| Unknown or Other | 0 | - | - | 4 | - | - | 7 | - | - | 1 | - | - | 12 | - | - |
| Total | 126 | 7.1% | 1.6% | 858 | 9.1% | 4.3% | 927 | 4.1% | 5.5% | 97 | 12.4% | 6.2% | 2008 | 6.8% | 4.8% |

Table 9. Average Rates of Barrier Containment Failure by Predominant Weather Condition

| Weather Condition | Penetration | Rollover |
|-----------------------------|--------------------|-----------------|
| No Adverse Effects | 9.8% | 6.7% |
| Rain | 6.9% | 2.1% |
| Snow or Sleet | 6.7% | 2.1% |
| Average Failure Rate | 9.3% | 5.1% |

Table 10. Average Rates of Barrier Containment Failure by Predominant Road Condition

| Road Condition | Penetration | Rollover |
|-----------------------------|--------------------|-----------------|
| No Adverse Effects | 11.5% | 6.8% |
| Wet or Pooling Water | 9.9% | 2.5% |
| Snow, Slush, or Ice | 6.1% | 3.8% |
| Average Failure Rate | 9.3% | 5.1% |

diminished. This is likely because travel speeds are reduced during inclement weather, and errant vehicles have generally lower CG trajectory angles.

- (2) In general, the number of rollovers and penetrations was lower during wet or snowy weather. Although states with higher annual precipitation experienced higher annual rates of vehicle penetration through the barrier systems, the locations of the cable median barriers in wetter states affected crash likelihood. As the volume of both rain and snow increased, median geometries tended to become steeper to assist with drainage off of the roadway. Steep median conditions aggravate penetration and rollover propensity.
- (3) Reductions in vehicle rollovers during inclement weather were caused by a significant decrease in contact friction between the tires of the vehicle and the wet or snow-covered ground. When contact friction was decreased, the roll moment applied to the vehicle in sliding conditions was significantly reduced. In penetration crashes, however, the vehicle was unable to slow down as effectively when the ground friction

was reduced. Furthermore, the vehicle was able to rotate to very high orientation angles on wet or snowy ground relative to dry ground. The largest rate of reduction of penetration crashes was related to adverse weather events is due to reduced travel speeds, and particularly a reduction in the effective impact angle present at the time of the crash. During dry road and median conditions, oversteering tended to produce high CG trajectory angles into the barrier and high orientation angles, since the ground-tire friction could produce large lateral forces on the vehicle. On low-friction wet or snow-covered ground and road, even in clear weather, less lateral force was available to redirect the vehicle's path, and CG trajectory angles were reduced.

4.2.2 Weather Conditions and Barrier Type

Rates of barrier containment failures by type of barrier were also investigated to evaluate the effect of weather on vehicle redirection. A comparison of crash results by barrier make and weather condition is shown in Table 11. Additionally, a comparison of crash result by barrier make and road condition is shown in Table 12. Since rollovers were frequently coded with crash results in DPS reports, rollover characteristics were available even when no scene diagrams were provided in some states. However, penetrations are not currently tabulated explicitly by most responding officers or DOTs, and thus a scene diagram was required to make the proper crash result determination. As a result, the total number of applicable crashes in the penetration database was substantially lower than the number of crashes in the rollover database.

It was observed that various proprietary barrier systems had markedly different rates of penetration and rollover. Although its database was limited in scope, the Brifen Wire Rope Safety Fence (WRSF) had the lowest rate of penetration when compared to other high-tension

Table 11. Crash Result per System in States with Complete Data Sets by Predominant Weather Condition

| Weather Conditions at Time of Crash | Low-Tension 3-Cable | | Brifren WRSF | | Nucor NU-CABLE | | Trinity CASS | |
|-------------------------------------|---------------------|--------------|--------------|--------------|----------------|--------------|--------------|--------------|
| | Crashes | Penetrations | Crashes | Penetrations | Crashes | Penetrations | Crashes | Penetrations |
| No Adverse Effects | 3020 | 224 | 56 | 3 | 333 | 40 | 1134 | 112 |
| Rain | 969 | 59 | 29 | 2 | 131 | 8 | 189 | 26 |
| Snow or Sleet | 243 | 13 | 33 | 3 | 213 | 15 | 652 | 33 |
| Fog or Mist | 28 | 6 | 0 | 0 | 7 | 2 | 16 | 2 |
| Strong Crosswind | 0 | 0 | 1 | 0 | 0 | 0 | 6 | 0 |
| Unknown or Other | 8 | 0 | 0 | 0 | 8 | 2 | 5 | 0 |
| Total | 4268 | 302 | 119 | 8 | 692 | 67 | 2002 | 173 |
| | | | 7.1% | 6.7% | 9.7% | 9.7% | 8.6% | 8.6% |

| Weather Conditions at Time of Crash | Low-Tension 3-Cable | | Brifren WRSF | | Nucor NU-CABLE | | Trinity CASS | |
|-------------------------------------|---------------------|-----------|--------------|-------------|----------------|-------------|--------------|-------------|
| | Crashes | Rollovers | Crashes | Rollovers | Crashes | Rollovers | Crashes | Rollovers |
| No Adverse Effects | 542 | 53 | 991 | 39 | 446 | 29 | 1183 | 94 |
| Rain | 159 | 7 | 338 | 3 | 168 | 3 | 209 | 1 |
| Snow or Sleet | 81 | 3 | 194 | 4 | 288 | 2 | 661 | 18 |
| Fog or Mist | 8 | 2 | 9 | 1 | 11 | 1 | 17 | 1 |
| Strong Crosswind | 0 | 0 | 3 | 1 | 3 | 0 | 6 | 0 |
| Unknown or Other | 5 | 0 | 9 | 0 | 9 | 2 | 5 | 0 |
| Total | 795 | 65 | 1544 | 48 | 925 | 37 | 2081 | 114 |
| | | | 8.2% | 3.1% | 4.0% | 4.0% | 5.5% | 5.5% |

Table 12. Crash Result per System in States with Complete Data Sets by Predominant Road Condition

| Road Conditions at Time of Crash | Low-Tension 3-Cable | | Brifren WRSF | | Nucor NU-CABLE | | Trinity CASS | |
|----------------------------------|---------------------|--------------|--------------|--------------|----------------|--------------|--------------|--------------|
| | Crashes | Penetrations | Crashes | Penetrations | Crashes | Penetrations | Crashes | Penetrations |
| No Adverse Effects | 437 | 53 | 37 | 3 | 278 | 34 | 879 | 93 |
| Wet or Pooling Water | 214 | 28 | 36 | 2 | 212 | 15 | 313 | 37 |
| Snow, Slush, or Ice | 135 | 14 | 46 | 3 | 199 | 18 | 793 | 43 |
| Unknown or Other | 9 | 0 | 0 | 0 | 3 | 0 | 17 | 0 |
| Total | 795 | 95 | 119 | 8 | 692 | 67 | 2002 | 173 |
| | | | 11.9% | 6.7% | 9.7% | 9.7% | 8.6% | 8.6% |

| Road Conditions at Time of Crash | Low-Tension 3-Cable | | Brifren WRSF | | Nucor NU-CABLE | | Trinity CASS | |
|----------------------------------|---------------------|-----------|--------------|-------------|----------------|-------------|--------------|-------------|
| | Crashes | Rollovers | Crashes | Rollovers | Crashes | Rollovers | Crashes | Rollovers |
| No Adverse Effects | 437 | 45 | 1269 | 45 | 374 | 30 | 951 | 76 |
| Wet or Pooling Water | 214 | 9 | 80 | 1 | 262 | 4 | 313 | 7 |
| Snow, Slush, or Ice | 135 | 10 | 193 | 2 | 284 | 3 | 800 | 31 |
| Unknown or Other | 9 | 1 | 2 | 0 | 5 | 0 | 17 | 0 |
| Total | 795 | 65 | 1544 | 48 | 925 | 37 | 2081 | 114 |
| | | | 8.2% | 3.1% | 4.0% | 4.0% | 5.5% | 5.5% |

systems. Conversely, Nucor Marion Steel's NU-CABLE system with three cables had a large database of hits and a considerable number of penetrations, with a penetration frequency of 9.7%. Additionally, the CASS and generic systems had intensive crash histories covering a broad geographical area, whereas the Nucor, Brifen, and Gibraltar systems were largely restricted to narrow geographical regions which affected distributions of weather patterns. Although Gibraltar's penetration frequency was higher than the Nucor system, the Gibraltar database too small in size to concretely determine penetration frequency and thus potential "outlier" cases contributed significant uncertainty.

Unfortunately, it was misleading to separate barrier statistics by manufacturer without a more intensive investigation into site details and state crash histories. Some states primarily use one type of barrier system. Since impact conditions and vehicle type can vary widely, these factors can lead to different propensities for penetration or rollover due to median geometries, traffic volumes, weather patterns, and barrier placement.

4.2.3 Weather and Time of Year

The number of crashes into cable barriers was plotted with severity against week number of each crash to determine if there was any additional adverse effect from the time of year, and by extension specific weather patterns, on crash severity and frequency. The result is shown in Figure 2. A significant spike in crashes was noted between December (beginning in week 47) and February (ending week 9), likely caused by snowstorms frequently in the states during the winter times. Crash frequency was also largely related to cultural patterns as well. For example, the spike in crashes during week 12 corresponds to the approximate time frame for collegiate spring breaks. However, no distinct pattern of fatalities could be discerned except for a small rise during summer months, which may be due to an increased number of vehicle miles traveled.

Crash Frequency and Outcome by Week Number

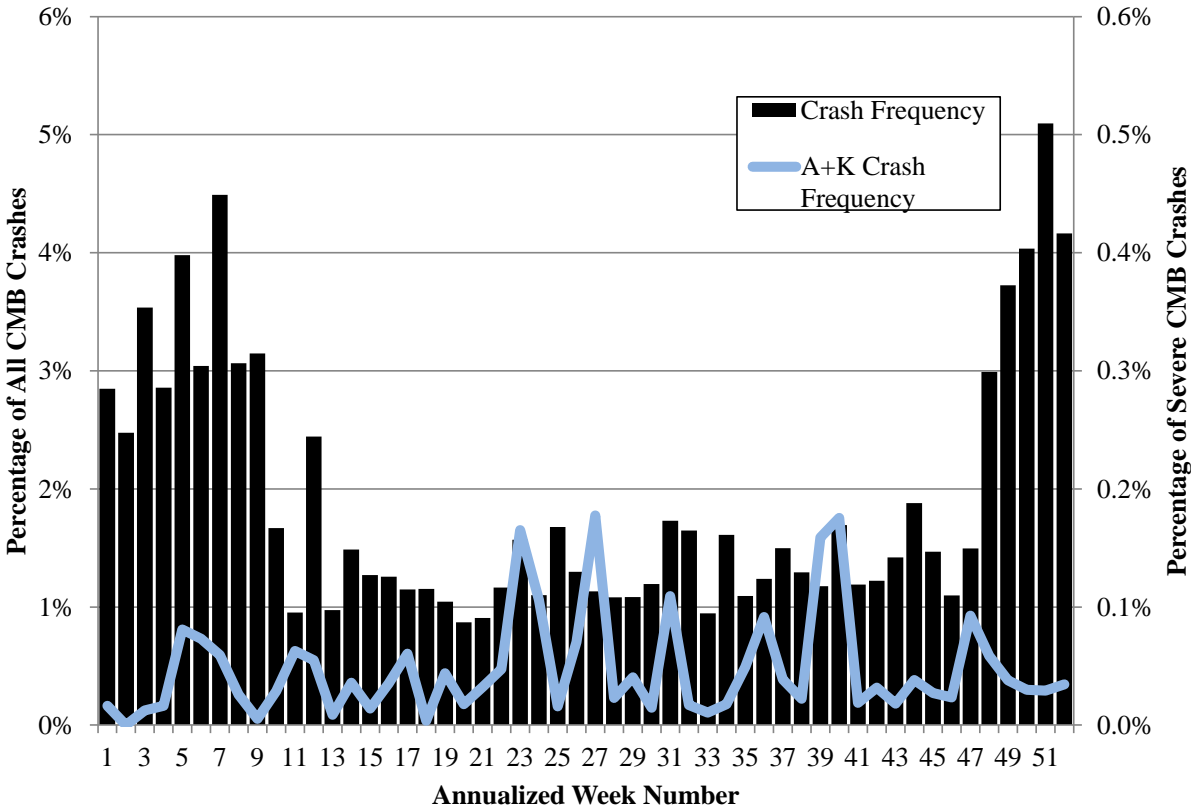

Figure 2. Crash Frequency and Severity by Week Number

For a different perspective, crash severity was also plotted by month, as shown in Figure 3. The number of crashes was significantly higher in the winter months, especially in December, when the first snows of each winter season usually fell. Monthly averages of fatalities were approximately constant between January and April, with increased numbers of fatalities in June, July, and September. This is likely the result of vacations and travel, which is more common in the summer. The analogous drop in fatalities and crashes in August is likely due to the end of summer travel and vacations and corresponds to the impending start of the school year.

Crash Frequency and Outcome by Month

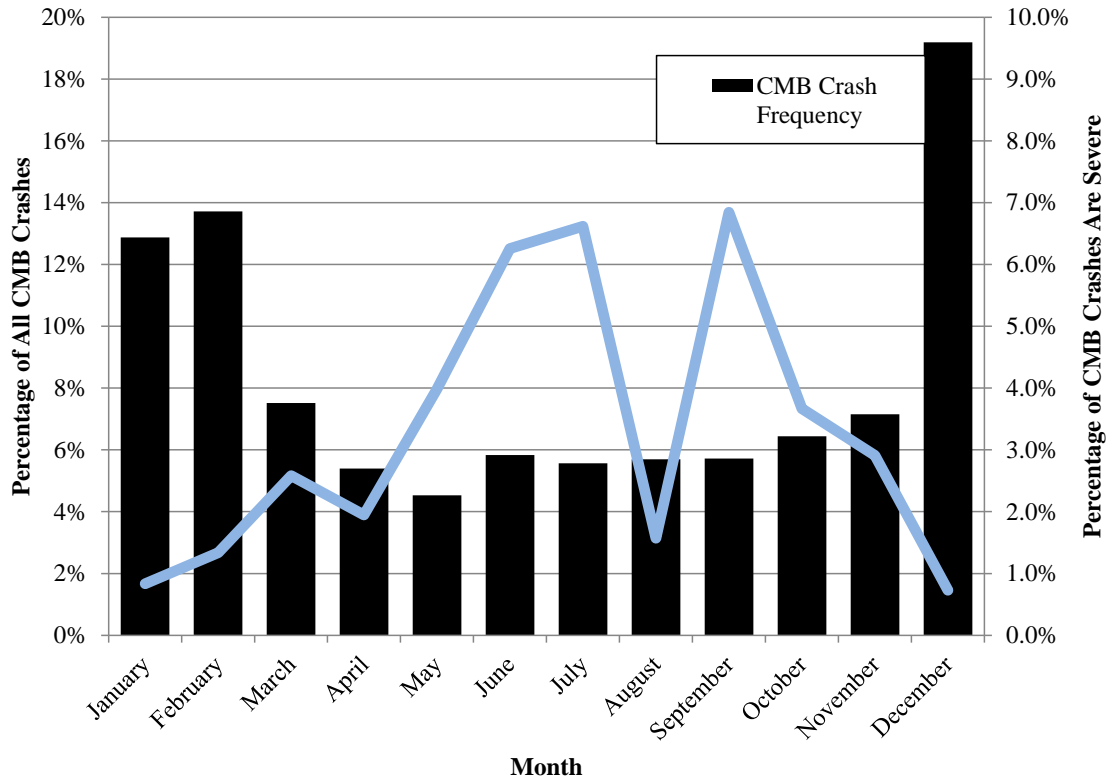

Figure 3. Crash Frequency and Severity by Month

4.2.4 Slope Characteristics

A frequently-cited parameter for the likely cause of barrier containment failures was related to median slopes and barrier placement within medians. Median slopes were investigated in several different states to determine the relative contribution to the crash result. Whenever it was possible, median geometries were obtained exactly using site details collected by DOT personnel or using geotechnical surveying equipment. The Ohio DOT was able to provide geodetic survey information for all roadways with cable median barriers installed. In other states, selected site tours and investigations using barrier geometries, photogrammetry, and reference configurations were applied to photographs of cable barriers at crash sites observable using the Google Maps Street View application.

The 857 cable median barrier crash records between 2007 and 2010 from Ohio were tabulated to determine the relative frequency of penetration and rollover crash events by median geometry. Crash results were tabulated by median geometries at the crash sites and are shown in Tables 13 through 15. Higher slope rates tended to increase penetration propensity, but there was a large number of penetrations which occurred on flat slopes or near roadway shoulders. Surprisingly, crashes into cable median barriers located on the back-side median ditch resulted in fewer penetrations than when the barrier was installed in either the ditch center or on the approach slope of the median. However, independent of barrier placement in the median, barriers placed in medians with flat approach slopes always had an equal or higher rate of penetration than barriers located on an approach slope with slope rates between 6:1 and 10:1. Since FHWA currently permits barriers to be placed on 6:1 or shallower approach slopes, these findings suggest that sloped median crashes may not be as critical as was first estimated.

Very few rollovers occurred on moderately steep slopes. Rollovers were more frequent on the shallower slopes. More than 71% of the rollovers occurred on approach slopes of 8:1 or flatter. Alternatively, 13% of rollovers occurred on medians with approach slopes steeper than 6:1. However, 56.7% of all crashes on Ohio roadways occurred on roads with slopes of 8:1 or flatter, and steep median crashes constituted 13.9% of all crashes.

For moderately steep slopes of 6:1 to 8:1, the vehicle tended to travel toward the center of the ditch (i.e. to the lowest point), since that is an energetically favorable position due to minimization of gravitational potential energy. Barriers installed on these slopes applied redirective forces which were largely parallel with the slope because of the orientation of the vehicle at impact. Whereas the initial applied load on the vehicle due to cable barrier systems was large, if the vehicle's orientation angle was not excessive, the slope tended to counteract the roll moment applied by the barrier on the vehicle. This was historically evident in most full-scale

Table 13. Crash Results for Flat or V-Ditch Medians with Barriers on Traffic-Side Slopes

| Barrier on Traffic-Side Shoulder or Slope | | | | | |
|--|------------|--------------|----------------|-----------|-------------|
| Approach Slope | Crashes | Penetrations | % Penetrations | Rollovers | % Rollovers |
| Steeper than 6:1 | 73 | 12 | 16.4% | 3 | 4.1% |
| 6:1-8:1 | 129 | 9 | 7.0% | 1 | 0.8% |
| 8:1-10:1 | 118 | 6 | 5.1% | 6 | 5.1% |
| Flatter than 10:1 | 174 | 17 | 9.8% | 9 | 5.2% |
| All Crashes | 494 | 44 | 8.9% | 19 | 3.8% |

Table 14. Crash Results for V-Ditch Medians with Barriers in Center of Ditch

| Barrier within 4 ft (1.2 m) of Center of V-Ditch | | | | | | |
|---|-------------------|------------|--------------|--------------|-----------|-------------|
| Approach Slope | Backside Slope | Crashes | Penetrations | Penetrations | Rollovers | Rollovers |
| Steeper than 6:1 | Steeper than 6:1 | 1 | 1 | 100.0% | 0 | - |
| | 6:1-8:1 | 6 | 0 | - | 0 | - |
| | 8:1-10:1 | 6 | 2 | 33.3% | 0 | - |
| | Flatter than 10:1 | 4 | 0 | - | 0 | - |
| Total | | 17 | 3 | 17.6% | 0 | - |
| 6:1-8:1 | Steeper than 6:1 | 7 | 1 | 14.3% | 0 | - |
| | 6:1-8:1 | 19 | 1 | 5.3% | 0 | - |
| | 8:1-10:1 | 11 | 1 | 9.1% | 0 | - |
| | Flatter than 10:1 | 8 | 2 | 25.0% | 0 | - |
| Total | | 45 | 5 | 11.1% | 0 | - |
| 8:1-10:1 | Steeper than 6:1 | 6 | 1 | 16.7% | 0 | - |
| | 6:1-8:1 | 15 | 1 | 6.7% | 0 | - |
| | 8:1-10:1 | 11 | 2 | 18.2% | 1 | 9.1% |
| | Flatter than 10:1 | 10 | 3 | 30.0% | 0 | - |
| Total | | 42 | 7 | 16.7% | 1 | 2.4% |
| Flatter than 10:1 | Steeper than 6:1 | 2 | 0 | - | 0 | - |
| | 6:1-8:1 | 2 | 0 | - | 0 | - |
| | 8:1-10:1 | 20 | 4 | 20.0% | 2 | 10.0% |
| Total | | 24 | 4 | 16.7% | 2 | 8.3% |
| All Crashes | | 128 | 19 | 14.8% | 3 | 2.3% |

Table 15. Crash Results for V-Ditch Medians with Barriers Installed on Back Slope

| Barrier on Opposite Slope of V-Ditch | | | | | | |
|---|-------------------|------------|--------------|--------------|-----------|-------------|
| Approach Slope | Backside Slope | Crashes | Penetrations | Penetrations | Rollovers | Rollovers |
| Steeper than 6:1 | Steeper than 6:1 | 12 | 0 | - | 0 | - |
| | 6:1-8:1 | 9 | 1 | 11.1% | 0 | - |
| | 8:1-10:1 | 4 | 2 | 50.0% | 0 | - |
| | Flatter than 10:1 | 4 | 1 | 25.0% | 1 | 25.0% |
| Total | | 29 | 4 | 13.8% | 1 | 3.4% |
| 6:1-8:1 | Steeper than 6:1 | 6 | 0 | - | 0 | - |
| | 6:1-8:1 | 30 | 1 | 3.3% | 0 | - |
| | 8:1-10:1 | 14 | 2 | 14.3% | 0 | - |
| | Flatter than 10:1 | 14 | 1 | 7.1% | 1 | 7.1% |
| Total | | 64 | 4 | 6.3% | 1 | 1.6% |
| 8:1-10:1 | Steeper than 6:1 | 12 | 0 | - | 0 | - |
| | 6:1-8:1 | 18 | 1 | 5.6% | 0 | - |
| | 8:1-10:1 | 23 | 3 | 13.0% | 3 | 13.0% |
| | Flatter than 10:1 | 15 | 1 | 6.7% | 1 | 6.7% |
| Total | | 68 | 5 | 7.4% | 4 | 5.9% |
| Flatter than 10:1 | Steeper than 6:1 | 3 | 0 | - | 0 | - |
| | 6:1-8:1 | 14 | 0 | - | 1 | 7.1% |
| | 8:1-10:1 | 57 | 7 | 12.3% | 2 | 3.5% |
| Total | | 74 | 7 | 9.5% | 3 | 4.1% |
| All Crashes | | 235 | 20 | 8.5% | 9 | 3.8% |

crash tests conducted on level and sloped terrain. Following redirection, vehicles departing cable barrier systems tended to redirect at very low angles [17-19]. Low-angle redirection on a 6:1 slope caused a subsequent continued engagement between the vehicle and the barrier, and the reactive force from the cable barrier largely balanced the overturning moment from the slope, improving vehicle stability. The competing roll influences are explained in greater detail in Chapter 8.

Occasionally, based on orientation angle, the vehicle yawed counterclockwise toward higher orientation angles (i.e., yawing with the left-front and right-rear corners leading) near a post location. When the yaw occurred on a slope, the vehicle pitched forward to allow the rear wheels to rise consistent with the slope, which increased local tire-ground friction. On shallower

slopes, the resistance was decreased, and on steeper slopes, resistance increased significantly. For moderate slopes such as 6:1 to 8:1 slopes, the increase in resistance due to yaw motion on the slope was not trivial but did not contribute to rollover; instead, these slope rates tended to resist yaw rotations to 90 degree orientation angles, then increased yaw tendency thereafter. If the vehicle did not trip as the vehicle orientation approached 90 degrees to the barrier, the vehicle stabilized and the trailing end of the vehicle rotated into the barrier and became the leading end. On flat or nearly flat slopes, there was no re-stabilizing slope which could shift the vehicle toward tracking in either frontal or rear directions. Instead, the increase in trailing-end tire friction due to tire slip tended to arrest the yaw motion of the vehicle near an orientation angle of 90 or 270 degrees and initiate rollover.

A statistical analysis was conducted on the slope data to determine how crash outcome depended on median approach slope rate. A chi-squared test on crashes in Ohio indicated that occupants of vehicles involved in penetration or rollover crashes were 5 times more likely to be seriously injured or killed than occupants involved in non-penetration or non-rollover crashes. Further segregation of the crash data and additional statistical tests indicated that penetration crashes were 3-times more likely to produce serious injury or fatality, and rollover crashes were 10-times more likely to involve A+K injuries, than non-penetration or non-rollover crashes.

Other chi-squared tests for independence were performed on the penetration and rollover frequency as a function of slope steepness. The chi-squared test for independence indicated that penetration frequency was not independent of slope steepness at the 10% confidence level, and rollover frequency was not independent of slope steepness at the 4% confidence level. An analogous but equally true statement would be that the risk of penetration would be correlated to slope steepness in no less than 90% of the cable median barrier crashes in Ohio, and the risk of

rollover would be correlated to slope steepness in no less than 96% of the crashes. However, the functional nature of the correlation was not a factor in this test.

Further investigation of the correlation demonstrated two trends which were supported by crash data in all of the participating states. In general, the highest risk of barrier penetration and rollover risk either occurred on slopes steeper than 6:1 or slopes flatter than 10:1. When the relative risk of rollover in each category was plotted against slope steepness, an asymptotic-like relationship was obtained in both system failure types. The penetration and rollover risk plots and interpolated risk curves obtained from this effort are shown in Figures 4 through 6. The lowest risk for both penetration and rollover combined occurred on median slopes between 7:1 and 6:1, and the risk increased for both steeper and flatter slopes. Rollovers were more frequent on level ground than on steep slopes in this study, although there were a limited number of very steep slopes in this database. Penetrations were much more frequent on steeper slope rates; this was expected and was consistent with the current state-of-knowledge of cable barrier design with respect to vehicle motion on slopes.

However, divided medians in Ohio were frequently wider than 50 ft (15 m). As a result, the bouncing and underride tendencies aggravated in narrow medians less than 40 ft (12 m) wide were not present in this database. Caution should be used when applying these results to narrow median applications.

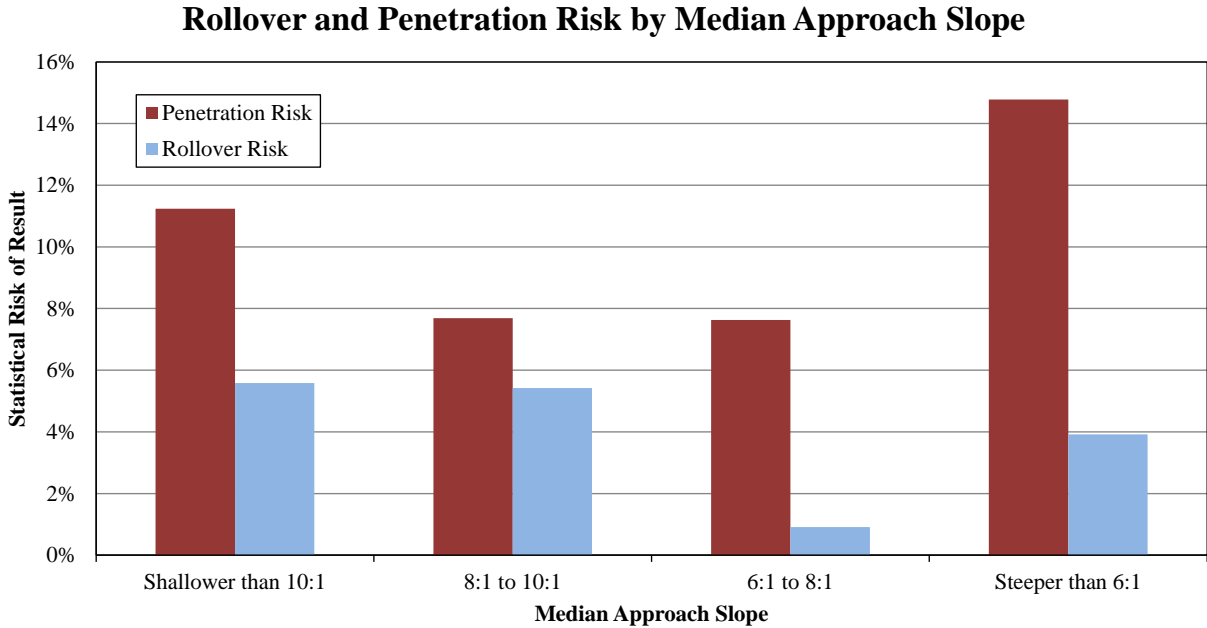

Figure 4. Statistical Analysis of Penetration and Rollover Risk by Median Slope

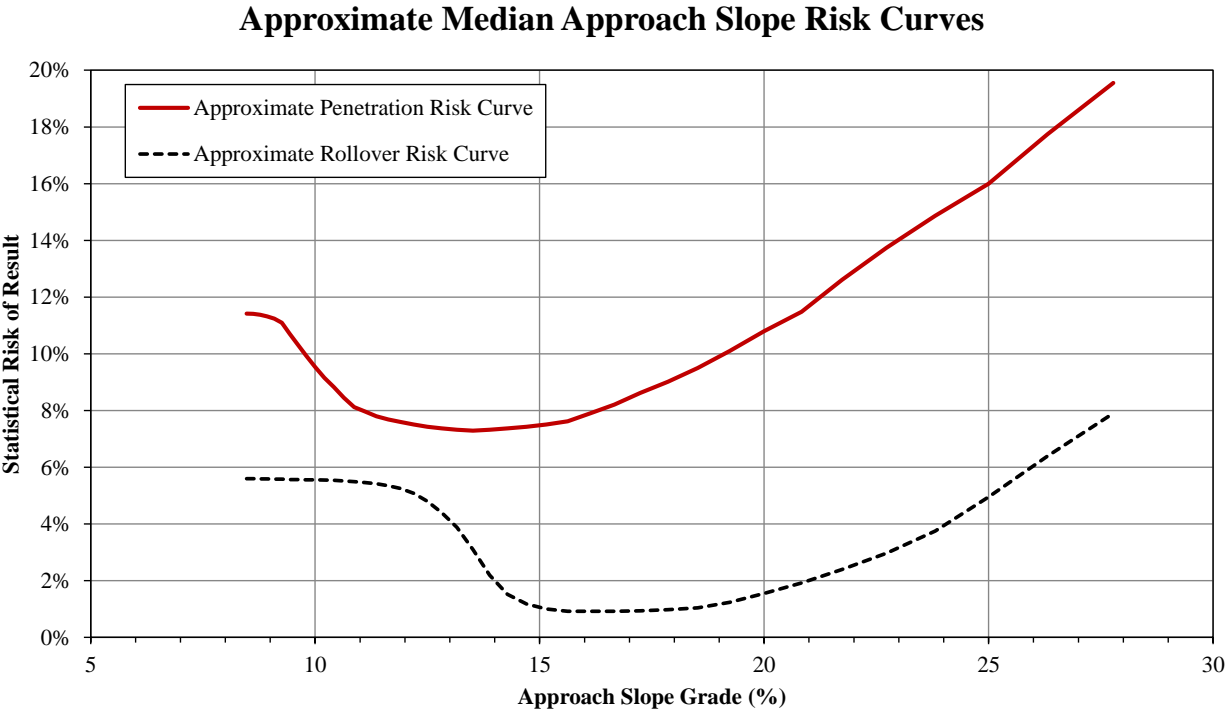

Figure 5. Estimated Median Approach Slope Risk Curves by Approach Slope Grade

Approximate Median Approach Slope Risk Curves

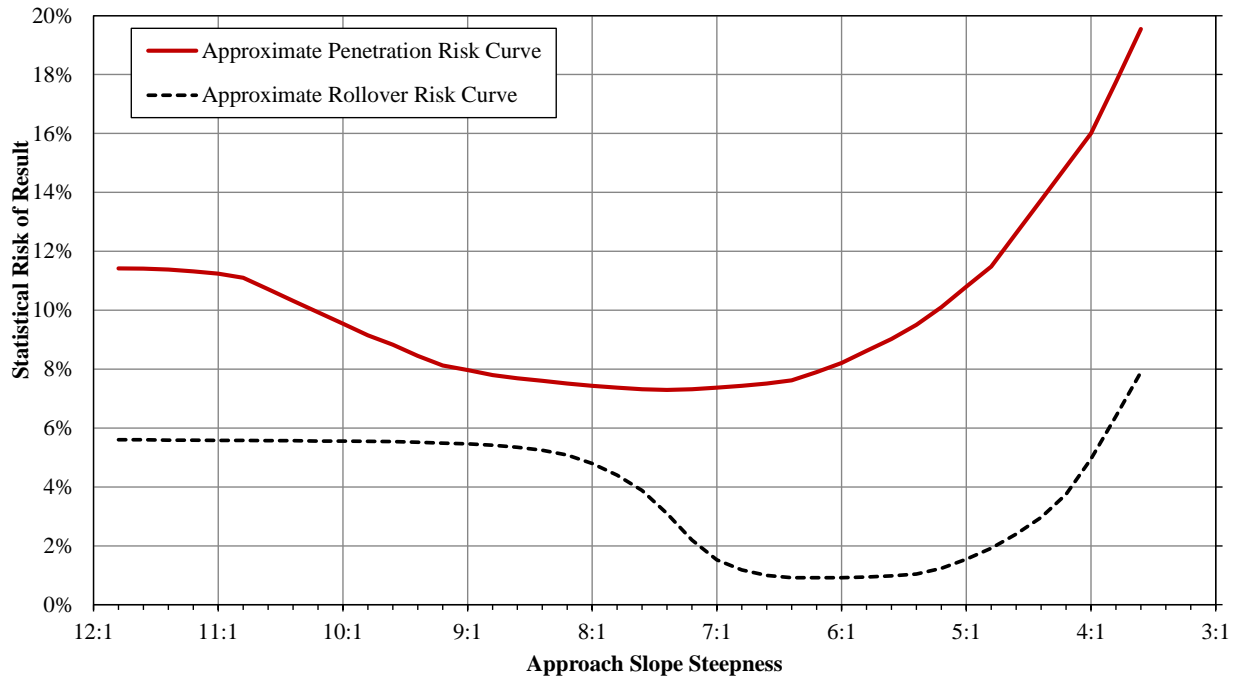

Figure 6. Estimated Median Approach Slope Risk Curves by Approach Slope Steepness

Approximately 80% of the crashes in the Ohio database occurred on Nucor NU-CABLE barrier systems. Precise slope data was not available at the time of this study from most of the other states and barrier systems involved in this research effort. Nonetheless, a concerted effort was made to tabulate approximate median conditions in other states with different barrier systems.

A database of Missouri median conditions available at all sites was beyond the scope of this study, but median geometries for serious crashes involving penetrations or rollovers were tabulated. The Missouri DOT had approximately 950 miles of low-tension, 3-cable median barrier installed on interstate roadways. Even though the vast majority of Missouri’s interstate system has V-ditches with slopes as steep as 4:1, many severe penetration and rollover crashes occurred on shallower slopes. Missouri’s severe crash data is shown in Tables 16 and 17. Unlike Ohio, many Missouri medians were relatively narrow, with widths of 40 ft (12 m) or less.

Table 16. Missouri’s Severe Penetration Crash Median Slope Summary

| Severe Penetration Crashes | | | | | | |
|-----------------------------------|----------------------|----------------|------------|----------------|-------------------------|------------|
| Approach Slope | Barrier Installed On | | | | All Severe Penetrations | |
| | Shoulders (Both) | Approach Slope | Center | Opposite Slope | | |
| 4:1-6:1 | 1 | 4 | 5 | 1 | 11 | 26% |
| 6:1-8:1 | 1 | 5 | 9 | 1 | 16 | 38% |
| 8:1-10:1 | 0 | 2 | 6 | 1 | 9 | 21% |
| Flatter than 10:1 | 1 | 2 | 2 | 1 | 6 | 14% |
| All Severe Penetrations | 3 | 13 | 22 | 4 | | |
| | 7% | 31% | 52% | 10% | | |

Table 17. Missouri’s Severe Rollover Crash Median Slope Summary

| Severe Rollover Crashes | | | | | | |
|--------------------------------|----------------------|----------------|------------|----------------|----------------------|------------|
| Approach Slope | Barrier Installed On | | | | All Severe Rollovers | |
| | Shoulders (Both) | Approach Slope | Center | Opposite Slope | | |
| 4:1-6:1 | 1 | 0 | 3 | 0 | 4 | 14% |
| 6:1-8:1 | 2 | 1 | 6 | 0 | 9 | 32% |
| 8:1-10:1 | 0 | 3 | 3 | 4 | 10 | 36% |
| Flatter than 10:1 | 0 | 2 | 3 | 0 | 5 | 18% |
| All Severe Rollovers | 3 | 6 | 15 | 4 | | |
| | 11% | 21% | 54% | 14% | | |

Despite the limited data set, some tendencies were clear. Barriers installed on approach slopes relative to traffic flow of encroaching vehicles in Missouri were more frequently involved in penetration crashes, and the most common location for penetration was when the median barrier was located near the center of the slope. This is not surprising, and the same effect was observed in the Ohio median slopes database. Barriers installed on approach slopes, back slopes, and the center of the V-ditch were subject to the greatest variation in front-end height and impact orientation angles of the impacting vehicle [20]. Since a large number of low-tension, 3-cable median barrier installations in Missouri were located near the center of relatively steep, narrow V-ditches, it was not surprising that center impacts were most common in both the severe penetration and severe rollover crashes. However, a proportionate distribution of crashes on each slope type was not available, so estimates of the rates of penetrations or rollovers based on slope steepness were not applicable.

Approximately 46% of all severe rollover crashes and 64% of all severe penetration crashes occurred on slopes steeper than 8:1; this indicates that rollovers were less frequent on the steeper slopes than penetrations were. The slopes flatter than 8:1 were relatively infrequent in Missouri where cable median barriers were installed, but still accounted for 54% of all severe rollover crashes. General observations about median slope performance were not applicable in Missouri, since the database did not incorporate non-severe crashes. However, variations in the results of the Ohio and Missouri databases were likely due to four reasons: (1) Missouri used a standard low-tension, 3-cable median barrier with S3x5.7 (S76x8.5) steel posts, which are stronger in weak-axis and strong-axis bending than most proprietary system posts; (2) the Missouri database was limited to only severe crashes; (3) slopes flatter than 6:1 were infrequent; and (4) medians were typically narrower in Missouri than in Ohio.

4.2.5 Vehicle Types

Vehicle types were classified using a simple heuristic combination of HLDI classifications of passenger cars, and segregation of light utility vehicles into van, SUV, and light truck profiles. The larger vehicle discretization was consistent with National Highway Transportation Safety Administration (NHTSA) definitions. The impact distribution by vehicle type is shown in Figure 7. The impact distribution represents the net contribution of each vehicle type to the total number of crashes. Thus, vehicles which had higher representation by sales volume were more likely to be over-represented in crash statistics. By comparison, relative rates of vehicle penetration and rollover are shown in Figure 8. The largest volume of crashes occurred with small and mid-size car vehicle classes, followed by pickup and SUV classes. As a result, they were oversampled in terms of penetration and rollover contributions. However, vans, tractor-trailers, and large cars all had very significant contributions to the frequency of penetration crashes.

Vehicle Representation in Cable Median Barrier Crashes

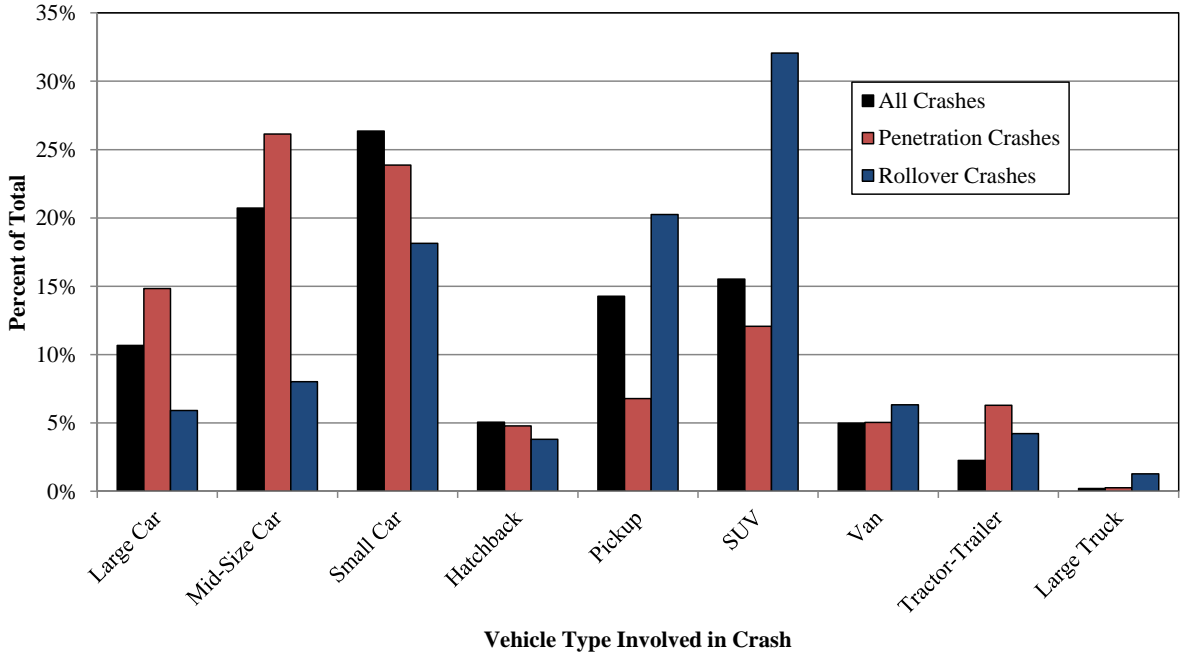

Figure 7. Vehicle Types Involved in Cable Barrier Crashes

Frequency of Cable Median Barrier Crash Outcomes

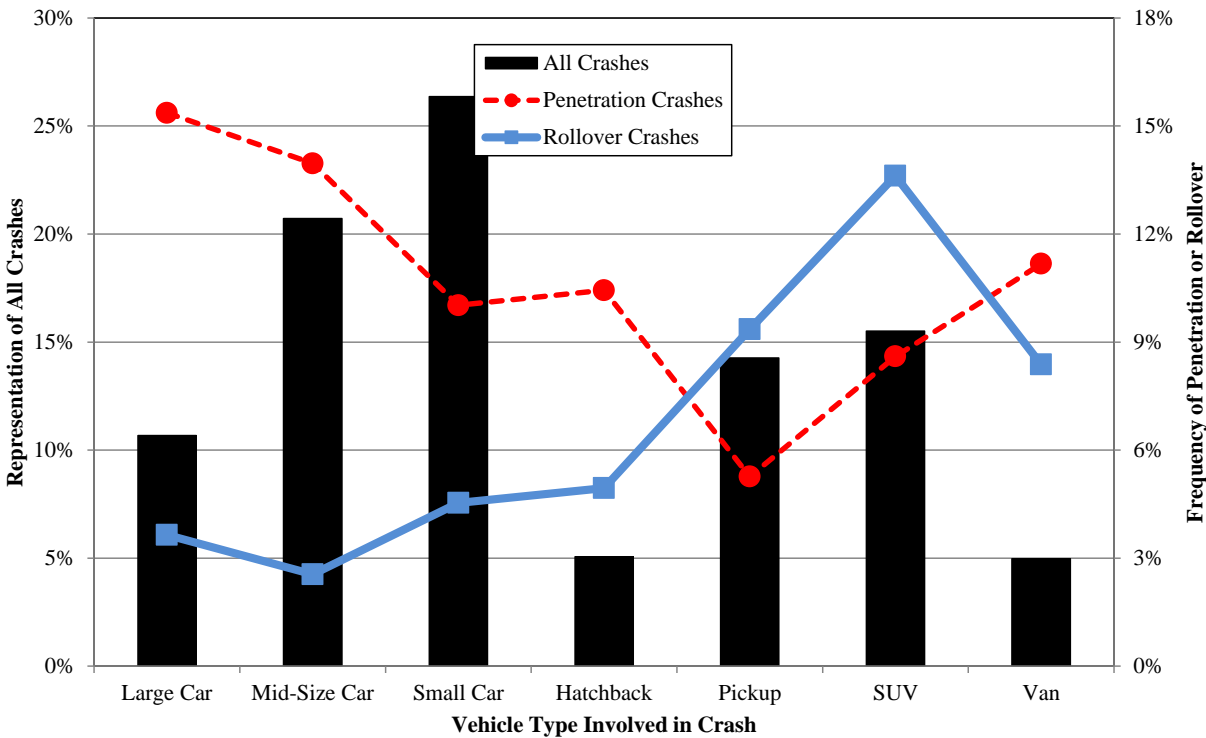

Figure 8. Frequency of Barrier Failure by Vehicle Type

Penetration and rollover occurrence was plotted by vehicle type, and indicated varying susceptibility to certain types of failure mechanisms. For example, mid-size cars had the highest total contribution of penetrations by vehicle type, but mid-size cars penetrated through the barrier less frequently than large cars, on a per-crash basis. Alternatively, large cars represented fewer numbers of penetrations than mid-size or small cars, pickup trucks, or SUVs, but large cars had the highest rates of penetration of any passenger vehicle.

A comparison of vehicles involved in severe crashes indicated that the serious injury and fatal crashes were distributed between all vehicle classes, as shown in Figure 9. The largest proportionate risk of serious injury or fatality occurred with hatchback or station wagon cars. These vehicles were frequently older vehicles with lower safety ratings than vehicles currently being produced. Also, SUV, van, and large car crashes were generally more severe than mid-size and small car crashes as well as pickup truck crashes. Only tractor-trailer crashes, with a high number of cross-median crashes and rollovers, had higher average severity for modern vehicles.

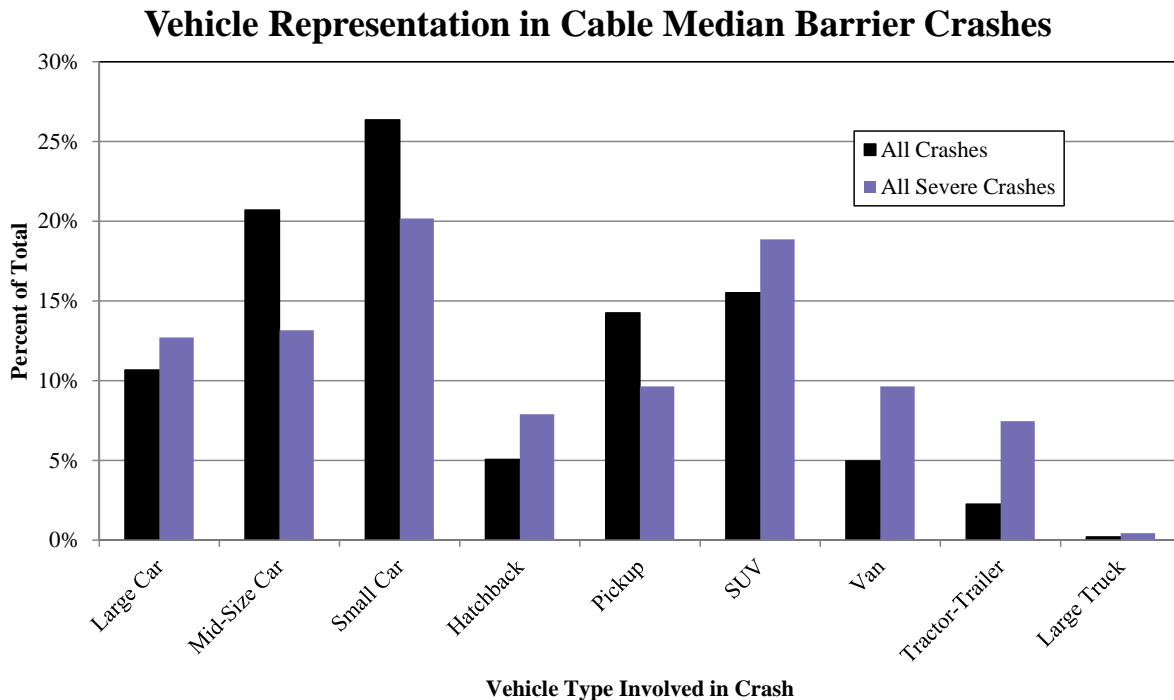

Figure 9. Risk of A+K Crash by Vehicle Type

The highest rates of barrier penetration leading to serious injury or fatality by passenger vehicles were the large car and hatchback vehicle classes; penetrations and rollovers represented the smallest total portion of serious injury or fatal crashes of mid-size vehicles as shown in Figure 10. Only 33% of all serious injury or fatal crashes involving mid-size vehicles were due to penetration or rollover, whereas 67% of the serious injury or fatal crashes were due to other factors. These factors include redirection into travel lanes causing secondary impacts, driver steering errors long after redirection, occupant contact with system components, and extraneous factors which cannot be controlled (i.e. unbelted occupants striking each other or the occupant compartment). The composite risk of serious injury or fatality due to penetration, independent of vehicle type, was determined to be 30.5%, and the contribution of rollovers to serious injury and fatality crashes was 27.4%, based on aggregate A+K data and crash result.

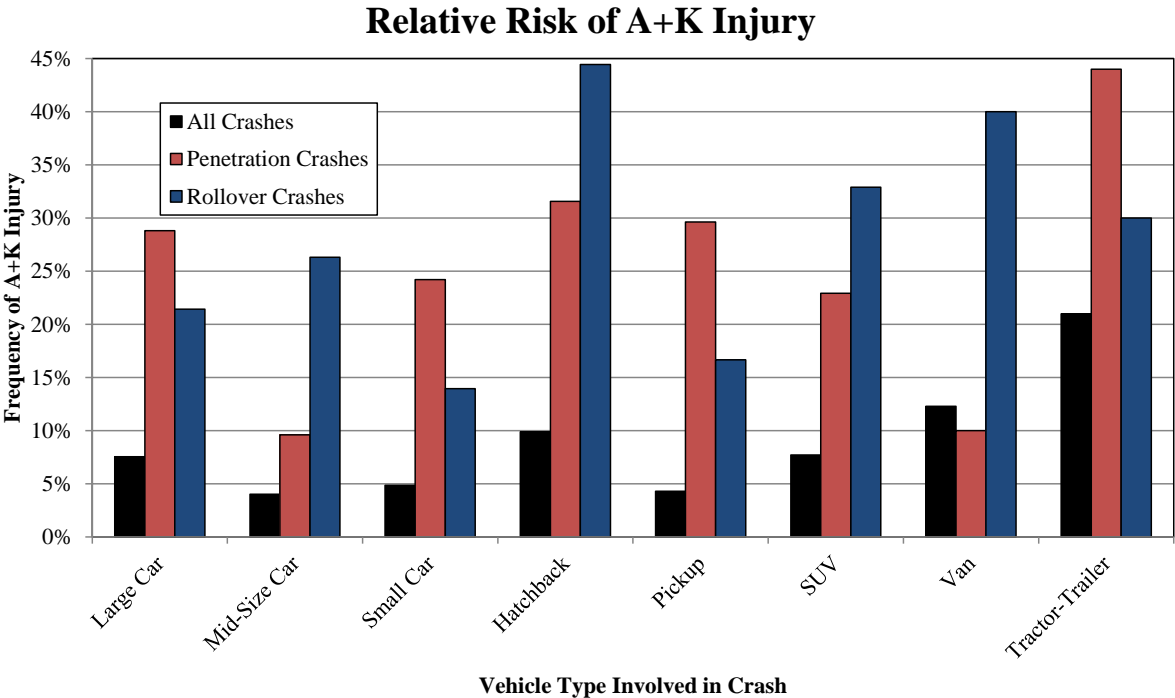

Figure 10. Frequency of Severe Injury by Crash Result and Vehicle Type

However, vehicle information was not available in all crashes. Many penetration crashes which resulted in head-on collisions caused extensive damage to the impacting vehicles. Frequently, impacting vehicles were no longer recognizable after the impacts and vehicle types were not transcribed on the crash forms; this led to underrepresentation of serious injury and fatal crash results in the vehicle crash database. Seventeen penetration crashes out of the 216 penetrations from states which provided crash vehicle make, model, and year could not provide impacting vehicle information; 2 of those 17 crashes were severe. Likewise, out of 217 rollovers from states which provided vehicle information, vehicle models could not be provided for 11 crashes; 2 of those 11 crashes were fatalities, and 7 were moderate injuries.

4.2.6 Vehicles Involved in Cable Median Barrier Crashes

Vehicle descriptions were tabulated to observe a broad cross-section of actual barrier impact conditions. Most states provided a class description for the vehicle which struck the barrier. In some states, the descriptor was generic and subject to the opinion of the responding officer who filed the crash report, and in some states, full vehicle make, model, year, VIN number, and Environmental Protection Agency (EPA) or Highway Loss Data Index (HLDI) vehicle classifications were provided.

Where possible, vehicle makes, models, and years were segregated into collective groups and similar vehicle body styles were grouped together. After preliminary evaluation, it was determined that the generic vehicle classes were insufficient to fully describe the complex strata of vehicle features, and similar-shaped vehicles were grouped into aggregate classes according to geometry. Tractor-trailer, large truck, and commercial or mass transit vehicles were excluded from the analysis. Distributions of vehicle impact data are shown in Figures 11 through 17. A comparison of wheelbase, longitudinal CG location, and curb weights of some sample test vehicles are shown in Table 18.

Distribution of Vehicle Wheelbase by Crash Result

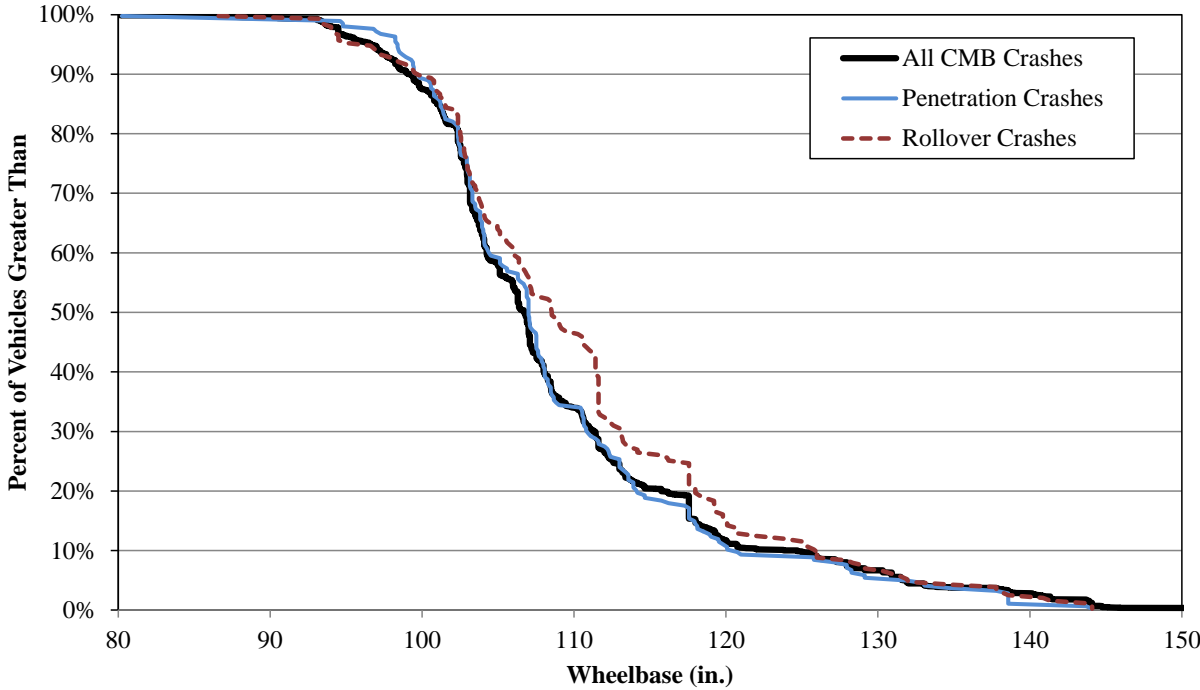

Figure 11. Distribution of Vehicle Wheelbase in CMB Impacts by Crash Result

Distribution of Vehicle Wheelbase by Severe Crash Result

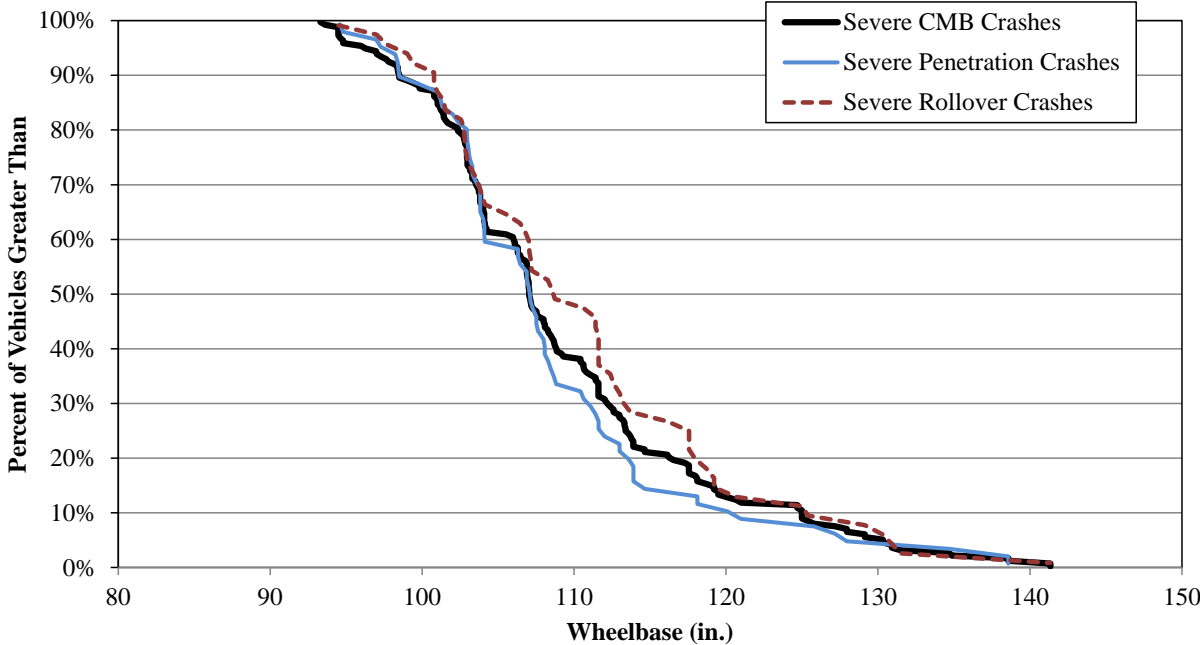

Figure 12. Distribution of Vehicle Wheelbase in Severe CMB Impacts by Crash Result

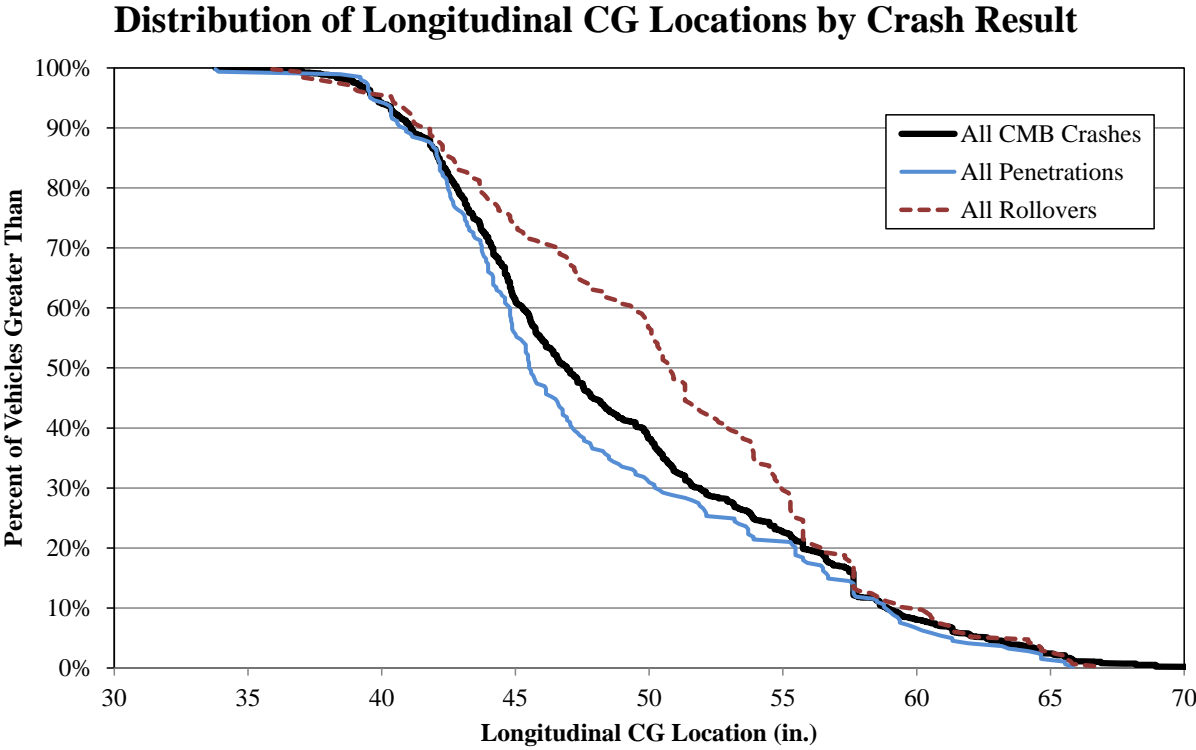

Figure 13. Distribution of Longitudinal CG Location in CMB Impacts by Crash Result

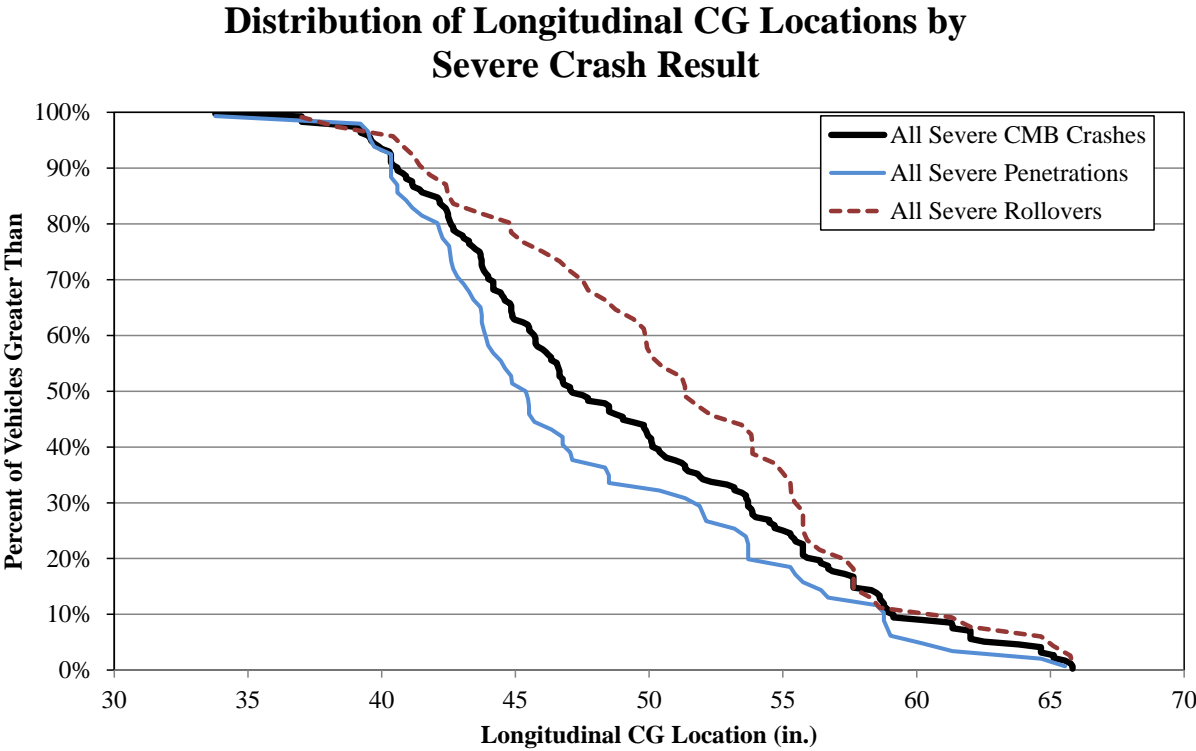

Figure 14. Distribution of Longitudinal CG Location in Severe CMB Impacts by Crash Result

Distribution of Vehicle Curb Weight by Crash Result

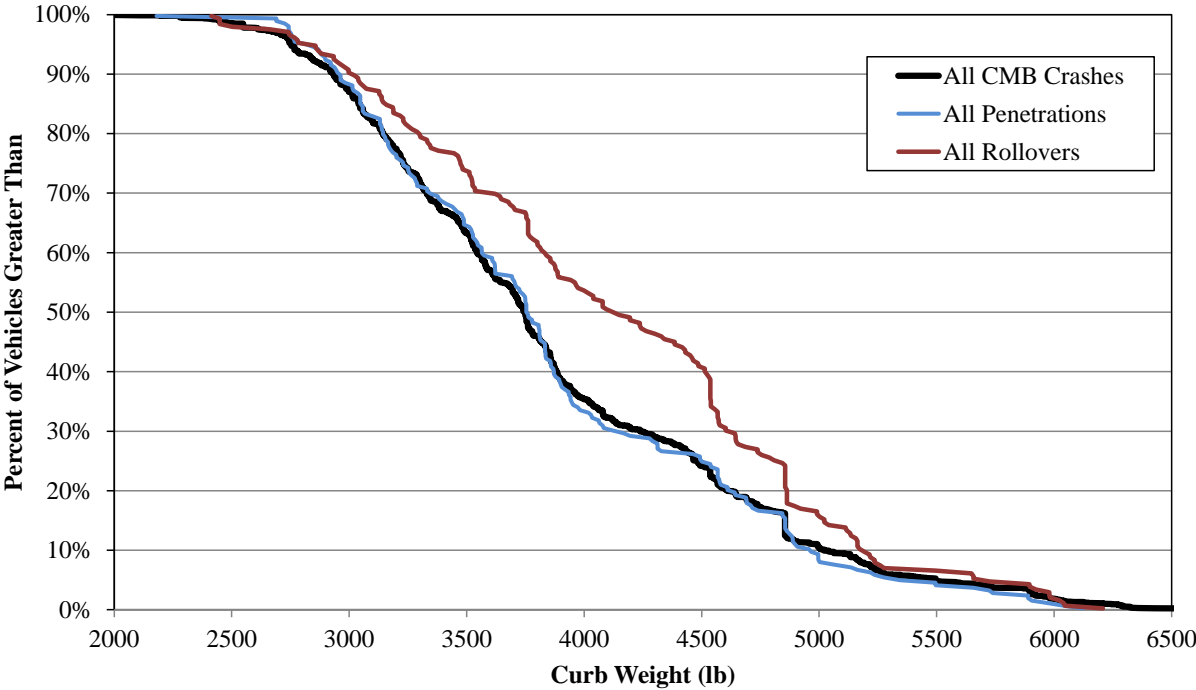

Figure 15. Distribution of Curb Weight in CMB Impacts by Crash Result

Distribution of Vehicle Curb Weight by Crash Result

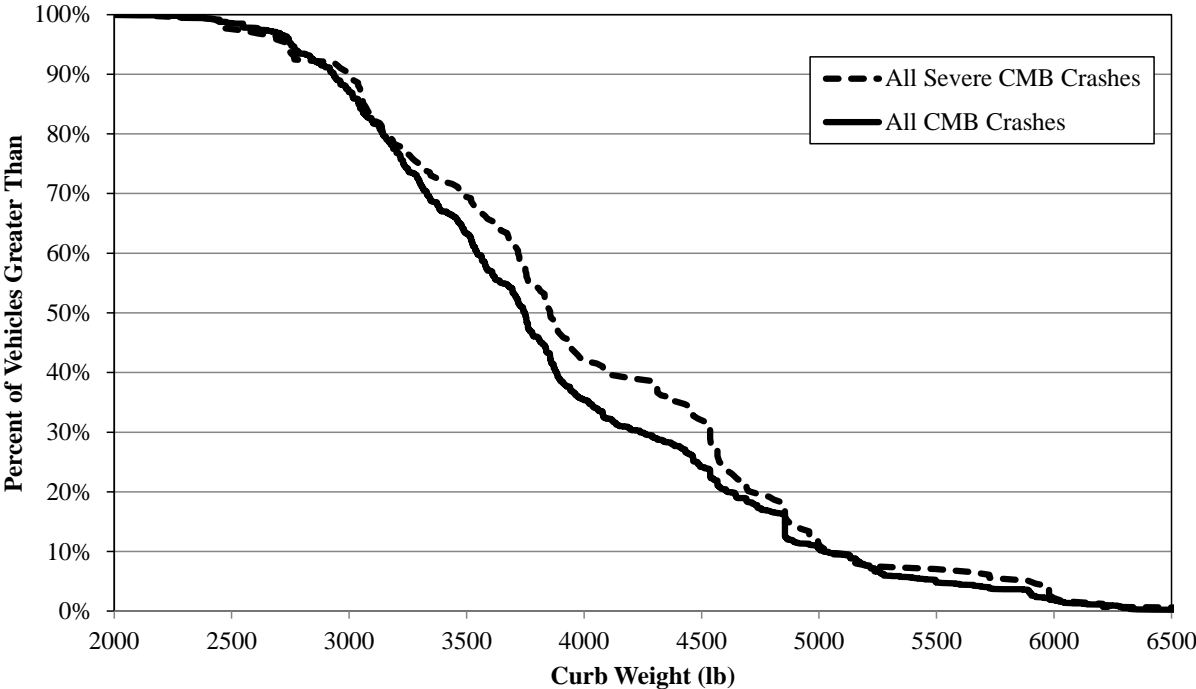

Figure 16. Distribution of Curb Weight in CMB Impacts, All Crashes

Distribution of Vehicle Curb Weight by Severe Crash Result

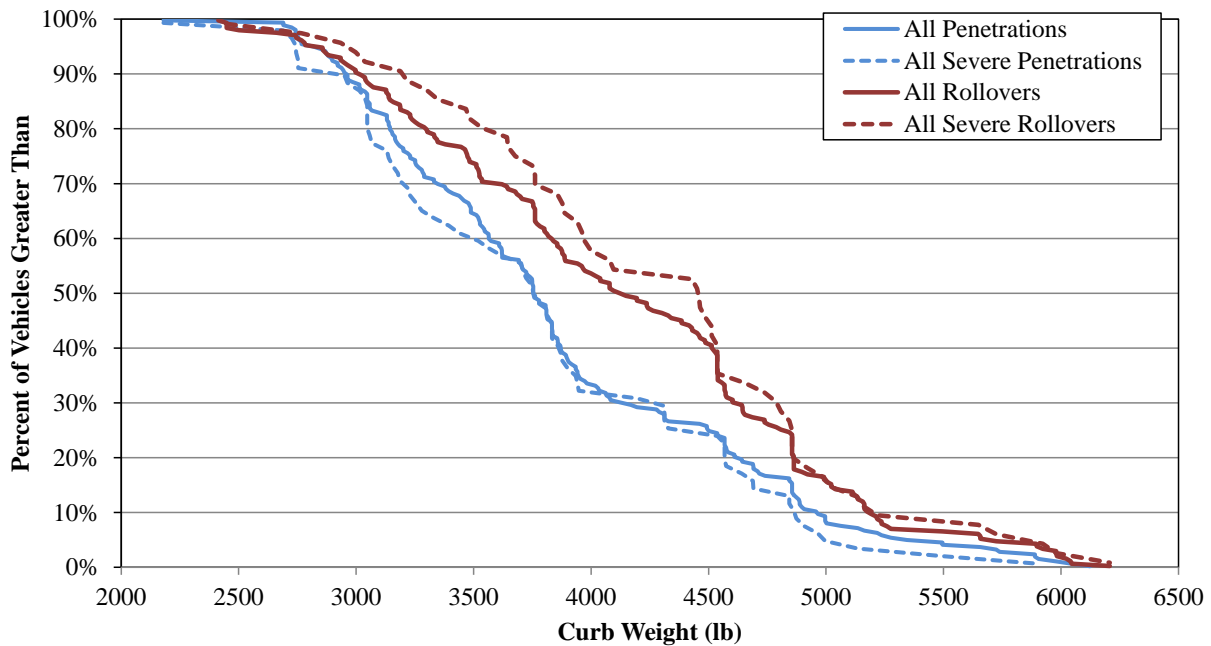

Figure 17. Distribution of Curb Weight in CMB Impacts, Penetration and Rollover Crashes

Table 18. Test Vehicle Dimensions and Weights

| Vehicle Designation | Sample Test Vehicle | Sample Wheelbase | | Sample Longitudinal CG Position | | Sample Curb Weight | |
|---------------------|----------------------|------------------|------|---------------------------------|------|--------------------|------|
| | | in. | mm | in. | mm | lb | kg |
| NCHRP 350 820C | 1995 Geo Metro | 93.1 | 2365 | 42.4 | 1077 | 1940 | 880 |
| NCHRP 350 2000P | 1995 Chevrolet C1500 | 155.5 | 3950 | 57.5 | 1461 | 4410 | 2000 |
| MASH 1100C | 2008 Kia Rio | 98.4 | 2499 | 45.4 | 1152 | 2365 | 1073 |
| MASH 2270P | 2008 Dodge Ram 2500 | 204.3 | 5189 | 61.3 | 1557 | 5418 | 2458 |

The distribution of vehicle wheelbase lengths was centered about 106.7 in. (2,710 mm), with 80% of the tabulated wheelbase lengths between 99.2 and 124.7 in. (2,520 and 3,167 mm). The severe crash subset was virtually indistinguishable from the larger set. This result suggested that severe injury and fatality crash rates were independent of wheelbase; it also suggested that wheelbase was not a critical factor in penetration crashes.

Although the available data set suggested that rollovers typically involved larger-wheelbase vehicles, chi-squared tests for independence of the data sets did not indicate statistical

significance. The p-values for rollovers and penetrations compared to the entire data set were 0.541 and 0.169, respectively. Severe crashes, consisting of only disabling or fatal (A+K) injuries, were extracted and compared. Student's t-tests performed on the means provided p-values for similarity of the means of 0.983 and 0.072 comparing the penetration to all crashes and rollover to all crash databases. Similarity was significant at the 2% level for the penetration set, and would be rejected at the 90% confidence level for the rollover set.

Curb weights in all rollovers were compared to severe rollovers and the p-value was 0.694. Likewise, p-values obtained by comparing severe penetrations to all penetrations and severe crashes to all crashes were 0.889 and 0.698, respectively. The results were generally outside the bounds of statistical significance, but the penetration data set was very close to the 90% level of statistical significance.

Longitudinal CG location distributions demonstrated considerably more variation than the wheelbase distributions. Again, the penetration database closely matched the distribution of all cable median barrier crashes, with a p-value of 0.198 in a chi-squared test for independence. However, the longitudinal CG location for the rollover data set was markedly different; longitudinal CG locations for vehicles in rollovers were much larger than in penetrations between the 80th and 20th percentiles.

A chi-squared test for independence in the database provided a p-value of $8.23(10^{-7})$, which was statistically significant. Thus, it can be concluded that the distributions of vehicles involved in rollovers and all CMB crashes were not dependent. A t-test for comparing means of the distributions was applied to the CMB crash set and rollover crash subset, and a p-value of 0.000285 was obtained. These results indicate a large likelihood that the data sets were not equivalent. A t-test was also applied to the penetration and composite data sets to determine similarity of the means of the two sets, and a p-value of 0.093 was obtained; this was significant,

since it indicated neither the rollover nor penetration data sets followed the same distribution as the entire, composite crash set.

The longitudinal CG location data set was segregated by crash severity, and severe crashes were compared to all crashes. Each distribution was slightly different; t-tests conducted on the severe penetration, rollover, and composite crash distributions gave p-values of 0.560, 0.509, and 0.485, respectively, and the means of the severe data sets were identical to the whole distributions. None of the p-values were statistically significant. However, overlaying the results indicated that severe rollover crashes were more likely to occur when the impacting vehicle CG location was further back from the front of the vehicle, whereas penetration crashes were more likely to occur when the CG location was closer to the front of the vehicle. The 15th and 85th percentile longitudinal CG locations for impacting vehicles involved in severe penetrations were 40.6 and 56.1 in. (1,031 and 1,425 mm), respectively, whereas the 15th and 85th percentile longitudinal CG locations for vehicles involved in severe rollovers were 42.5 and 57.6 in. (1,080 and 1,463 mm), respectively.

Curb weight distributions were also compared, as shown in Figures 15 through 17. Curb weights ranged from 1,795 to 7,695 lb (814 to 3,490 kg). Surprisingly, the weight of an NCHRP Report 350 test vehicle, approximately 1,808 lb (820 kg), was in the 0.4 percentile range; this is considerably lower than the intended 2nd percentile target. Even the MASH 1100C vehicle, which has a nominal weight of 2,425 lb (1,100 kg), was in the 1.2 percentile. The actual 2nd percentile weight was 2,550 lb (1,157 kg). By comparison, the NCHRP Report 350 pickup, frequently a C2500 truck weighing 4,409 lb (2,000 kg), was in the 73rd percentile, whereas the MASH 2270P pickup weighing 5,000 lb (2,268 kg) was in the 90th percentile of passenger vehicles. The 85th percentile weight of the distribution was 4,855 lb (2,202 kg), and the 95th percentile weight was 5,496 lb (2,492 kg).

The rollover distribution was largely characterized by heavier vehicles, as shown in Figure 15. The rollover data set diverged from the composite set at approximately the 96th percentile weight of 2,743 lb (1,244 kg) and did converge again until the 6th percentile weight of 5,276 lb (2,393 kg). The t-test performed on the rollover data set compared to the composite indicated a p-value of $1.26(10^{-5})$, which indicated that the data sets did not have the same mean. Likewise, a chi-squared test for independence on the rollover and composite sets provided a p-value of $3.26(10^{-7})$, which indicated that the two sets were unrelated.

By comparison, a t-test performed comparing means of the penetration versus composite data sets provided a p-value of 0.954, which is significant at the 5% level. This indicates the sets were similar. With regards to roadside safety, such a high level of agreement is rarely obtained. Likewise, the chi-squared tests performed on the databases indicated a likelihood of dependence of 0.806, which approached statistical significance with respect to the database similarity.

However, the same could not be said of the severe crashes. A t-test comparison of the means between severe penetrations and all penetrations, severe rollovers and all rollovers, and severe crashes and all crashes, provided p-values of 0.354, 0.275, and 0.040, respectively. The p-values for the penetration and rollover data sets were not statistically significant but suggest that the data sets are not likely similar. The p-value for the severe and all crashes database was statistically significant and indicated the average vehicle involved in severe CMB crashes was heavier than the average vehicle involved in a cable median barrier crash.

Rollovers and penetrations accounted for 70% of all serious and fatal crashes into cable barriers in which the barrier had a significant role in the injury in Missouri. Of the remaining 30% of cable median barrier crashes with severe injuries or fatalities, most were severe injury crashes involving occupant contact with a post element or ejection from the vehicle when the vehicle remained upright, although there was an approximately 5% contribution from

motorcyclists and passenger vehicles which were redirected into adjacent traffic and were injured in a secondary impact.

4.2.7 Impact Conditions

Vehicular impact conditions were investigated by performing crash reconstructions with available scene diagrams and photographic evidence, when available. A total of 110 severe crashes with enough information to reconstruct the crash were analyzed in the state of Missouri. Vehicle CG trajectory, orientation, and sideslip angles were calculated. Unfortunately, roadway curvature data was not available, which would allow for comparison of expected and actual CG trajectory angles; however, most roadways were straight in this study.

The CG trajectory angle was defined as the angle formed between the vehicle CG path and a tangent line to the barrier at the point of impact (POI). The vehicle orientation angle was defined as the angle formed by a driver's line of sight (LOS) and a tangent line to the barrier at the POI or equivalently, the angle between the vehicle's centerline and the barrier tangent. The sideslip angle represented the degree to which a vehicle was "tracking", a condition in which the rear tires follow the tracks of the front tires. Sideslip angles were measured between the CG trajectory angle and the orientation angle of the vehicle at the POI. For both trajectory and orientation angles, a vehicle heading toward the median ranged between 0 and 180 degrees; heading angles directed away from the median ranged between 180 and 360 degrees. A vehicle heading parallel with a tangent to the roadway at the point of departure was defined as 0 degrees.

Trajectory angles were plotted by orientation angle and sideslip angle, and are shown in Figures 18 and 19. Although sideslip angles between the path of the vehicle and heading can exceed 90 degrees, very high sideslip angles were generated by non-zero yaw rates; this is assumed to be an effective non-tracking impact condition. Moreover, if the driver was conscious and aware enough to steer the vehicle in avoidance maneuvers, a large number of drivers will

A+K Orientation and Trajectory Angles

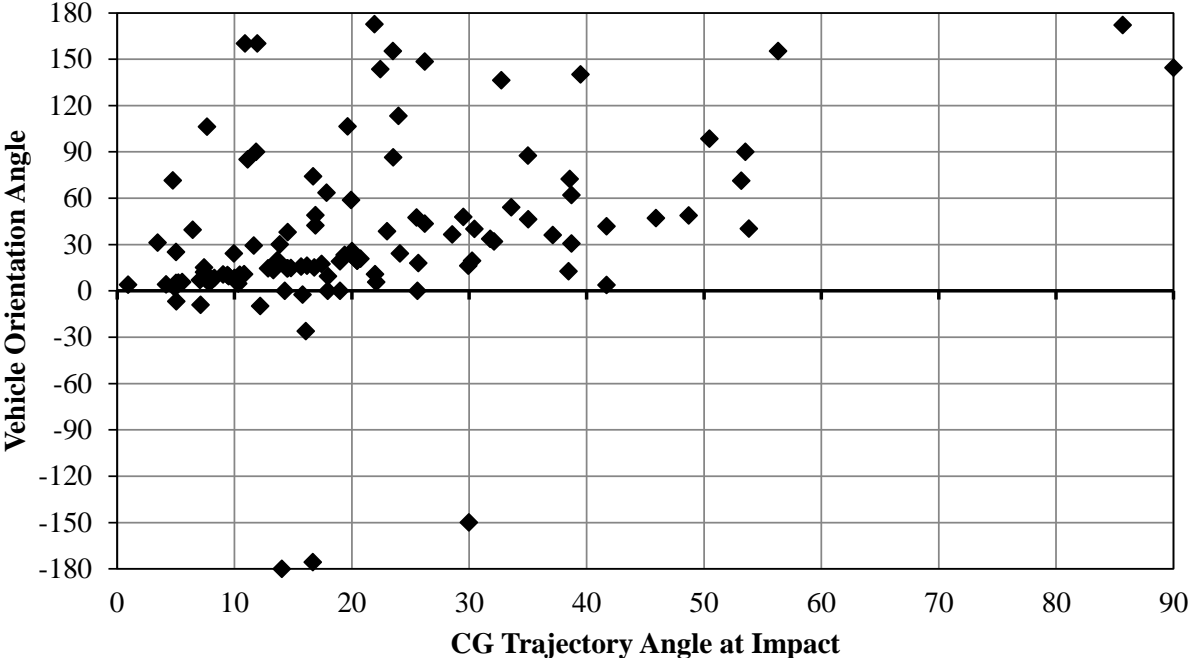

Figure 18. CG Trajectory and Orientation Angles in Severe Cable Median Barrier Crashes

A+K Sidelip and Trajectory Angles

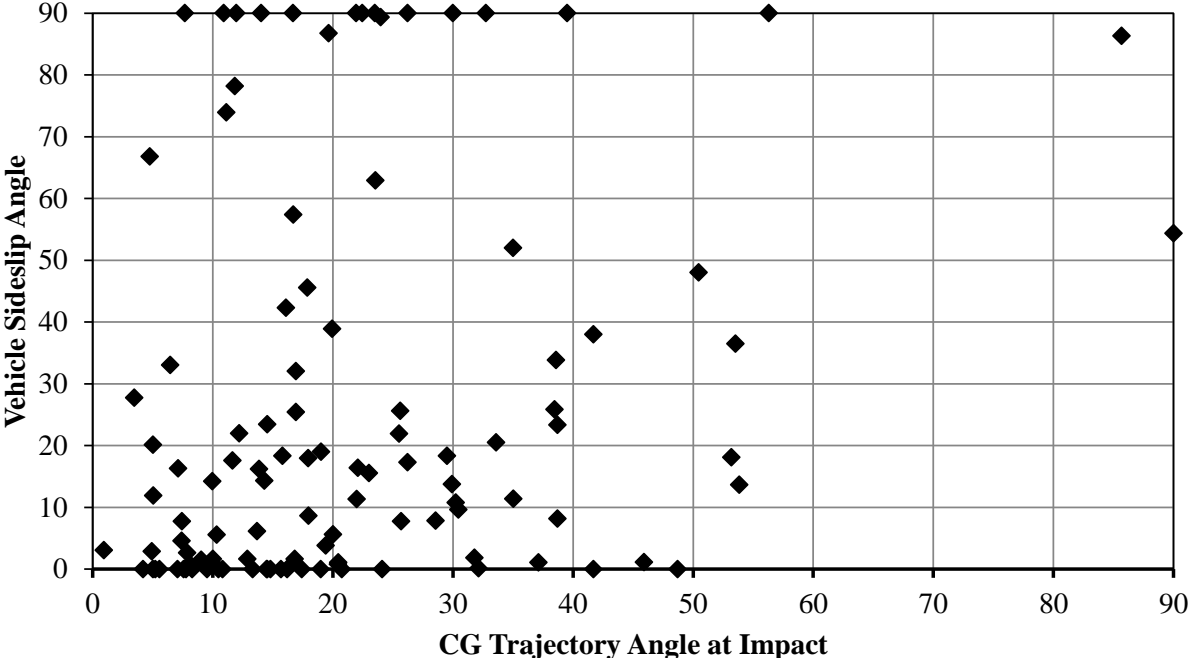

Figure 19. CG Trajectory and Sideslip Angles in Severe Cable Median Barrier Crashes

also instinctively apply the brakes and attempt to stop an errant vehicle, which further contributes to non-tracking behavior. The threshold between when a vehicle was considered tracking and non-tracking was determined to be approximately 20 degrees by researchers studying non-tracking behavior on crash results [21].

The trajectory angle distribution was very high relative to other studies conducted on severe crash results. The severe CMB crash results were compared to the distribution of severe crash results in the 2010 NCHRP Report No. 665 database [22], as shown in Figure 20. Historically, the roadside safety community collectively agreed that the 85th percentile impact condition for both speeds and angles could be regarded as a practical worst-case impact scenario to evaluate roadside hardware. As has been discussed in depth, selection of practical impact conditions should not be subjective and should be relatively stringent to capture, contain, or redirect the majority of impacting vehicles [23]. In NCHRP Report No. 665, the 85th percentile impact condition was a 25-degree departure angle relative to the roadway at 62.1 mph (100 km/h). The departure angle was selected in lieu of the impact angle when determining appropriate testing conditions. This angle was selected for of many reasons, including:

- (1) Initial impact location was affected by proximity of the struck object to the sides of the road. On some roadways, the clear zone extended well beyond the shoulders, and the location of impact was further from the roadway than most barriers are currently placed. Furthermore, impacts far from the road permit the vehicle to slow down to low speeds, reducing the crash severity that would normally occur with a barrier at much closer proximity.
- (2) In many multiple-impact events, selection would have to be applied to determine which event was most significant, which introduces both subjectivity and error. Energy contributions were frequently very difficult to partition to individual impacts.

- (3) Barrier crashes were undersampled in the NCHRP Report No. 665 database. The small barrier crash data set prohibited meaningful statistical analysis out of barrier crash results. Furthermore, the majority of the barrier impact events were at much higher speeds than occurred in typical barrier crashes.
- (4) Some impacts, such as rollovers, did not have a clearly defined CG trajectory angle leading to impact. Vehicle orientation during these types of crashes was frequently difficult to determine. Orientation and departure angles were not only easier to measure at departure, they were often more meaningful, since crash testing has historically been conducted with fully-tracking vehicles.

Trajectory Angle Distribution Comparison

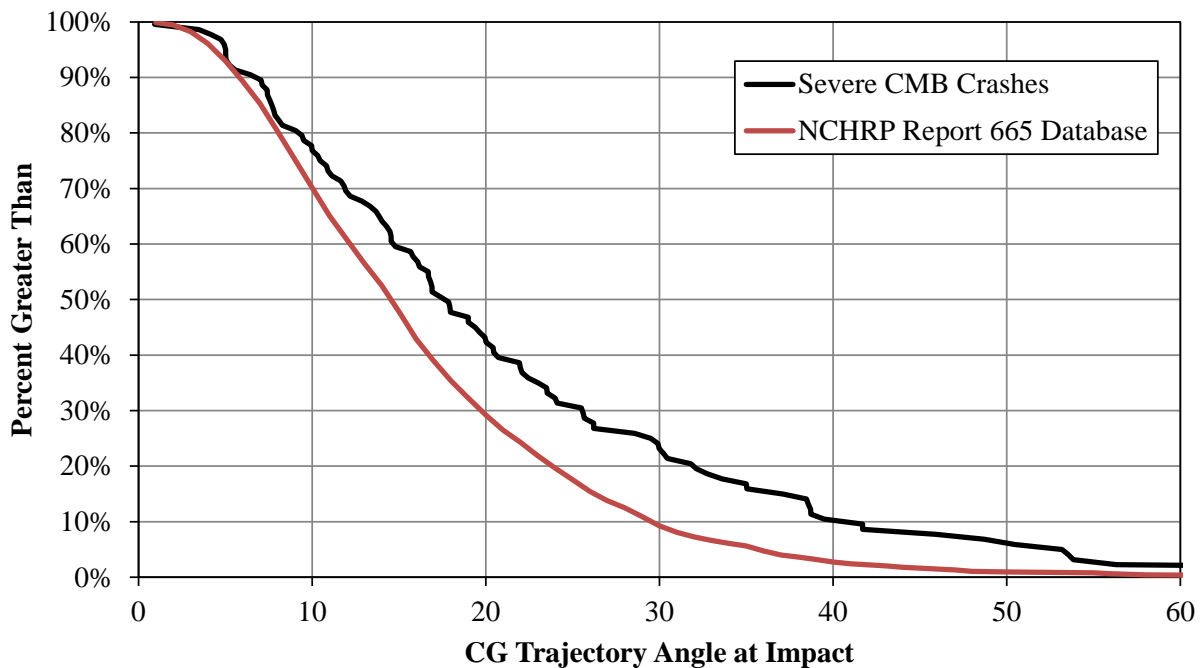

Figure 20. Comparison of Trajectory Angle Distributions

CG trajectory and orientation angles at the first impact location obtained from the NCHRP 665 database were much closer to the corresponding angles at impact measured in the severe cable median barrier crashes in Missouri. The 85th percentile CG trajectory angle of

severe cable median barrier crashes was determined to be 39 degrees at impact. By contrast, a CG trajectory angle of 25 degrees, which is the current standard in MASH, represented the 69th percentile of crash conditions in Missouri. If current MASH crash tests were conducted at the same speed but the angle was increased from 25 degrees to 39 degrees, the impact severity (IS) of the crash would increase by 120%. Few cable median barriers have been subject to this level of scrutiny.

The CG trajectory and orientation angle plot was segregated by crash result into “Penetration”, “Rollover”, or “Other” categories. The segregated database is shown in Figure 21, and a detail view for vehicle orientation angles greater than -10 degrees is shown in Figure 22.

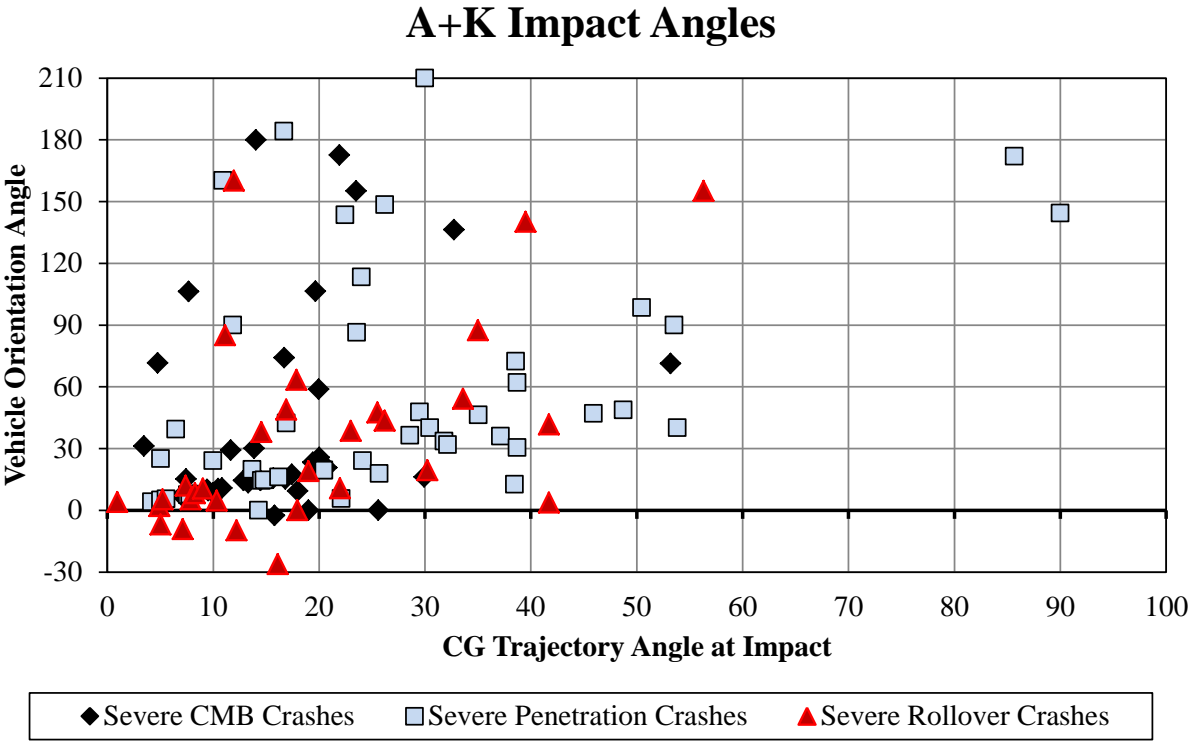

Figure 21. CG Trajectory and Orientation Angles by Crash Result

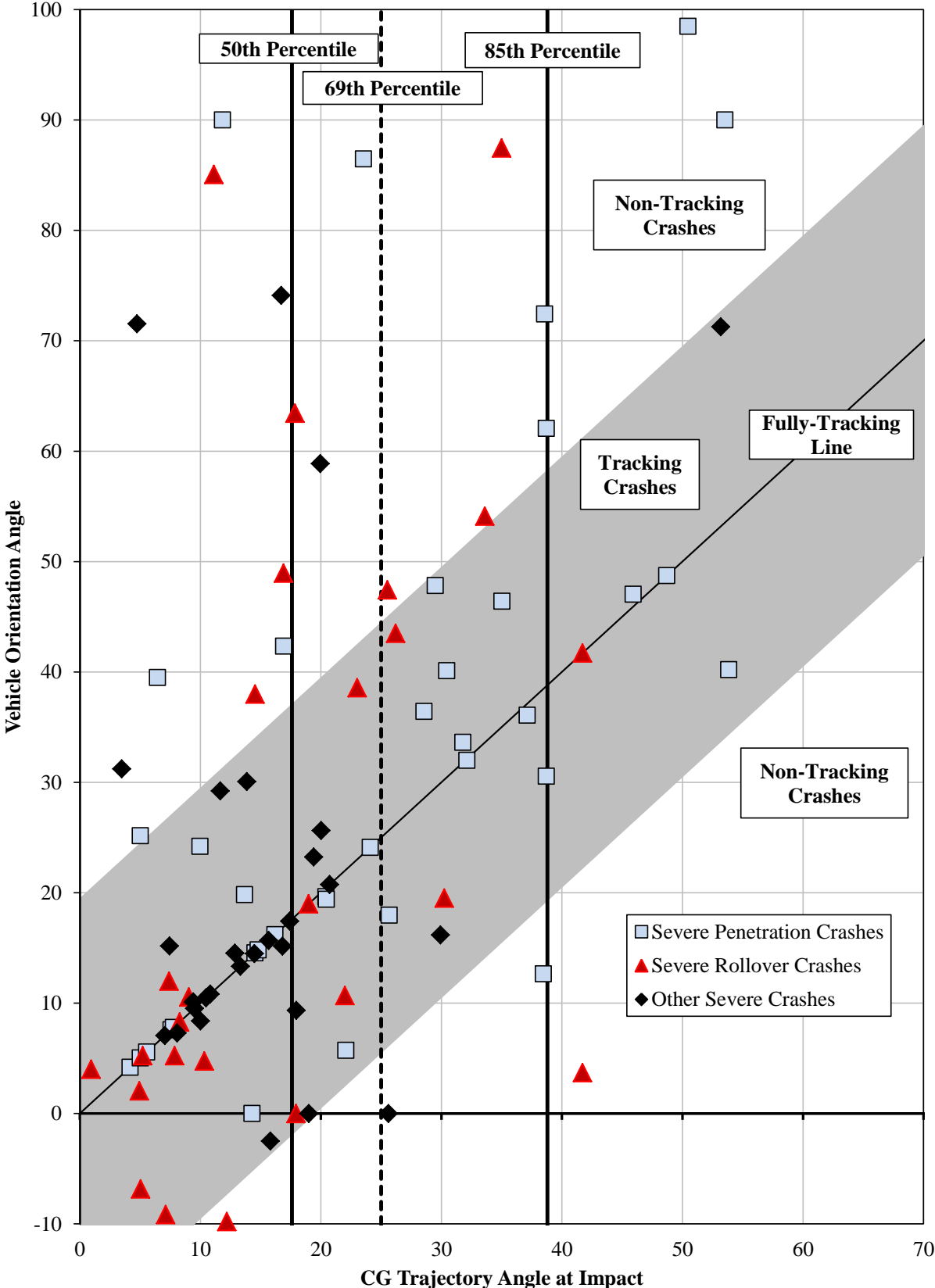

Figure 22. Detail View of Severe Crash CG Trajectory and Orientation Angles in Missouri

Of all the severe cable median barrier crashes, 43% occurred with sideslip angles in excess of 20 degrees. Approximately 40% of penetration crashes were non-tracking at impact with the barrier. Severe penetrations occurred more commonly at higher CG trajectory angles than severe rollovers. The median CG trajectory angle in severe penetration crashes in Missouri was 24 degrees, and the 85th percentile angle was 46 degrees.

Surprisingly, in Missouri, 63% of the severe rollover crashes that were caused by the cable median barrier occurred with CG trajectory angles less than 20 degrees. The median CG trajectory angle for the severe rollover crashes was 16 degrees, and the 85th percentile CG trajectory angle was 35 degrees.

Very few crashes occurred with “overcorrecting” and non-tracking impact conditions in which the driver of the vehicle was attempting to steer the vehicle away from the barrier. Overcorrecting impacts had heading angles nominally less than, or clockwise with respect to, CG trajectory angles. This type of orientation tended to promote a more “broadside” impact condition, where the side of the vehicle makes first contact with the barrier instead of the front or back ends. This was likely a product of the generally steep terrain found in Missouri’s medians, and relatively narrow medians typically measuring 40 ft (12.2 m) wide. Drivers who steered into the median would then find it very difficult to steer away from the barrier and back up the approach slope, which could have contributed to fewer “overcorrecting” impacts.

Alternatively, “oversteering” impacts, in which the orientation angle of the vehicle was larger than, or counterclockwise with respect to, the CG trajectory angle were very common. Approximately 51% of severe penetration crashes, 53% of severe rollover crashes, and 49% of all severe crashes had “oversteering” conditions. Comparatively, 83% of severe penetrations, 85% of severe rollovers, and 82% of severe non-penetration, non- rollover crashes with non-tracking impact conditions were “oversteering” crashes. The high number of oversteering crashes

in the median was a reflection of median geometry and roadway conditions. Vehicles which strike a cable median barrier located near the center of a V-ditch have a minimum lateral offset that must be traversed before impact, which tends to bias crash results toward higher CG trajectory angles.

The crash set was further evaluated by considering the relationship between CG trajectory angle and containment rate for severe crashes. A cumulative distribution plot of CG trajectory angle for severe penetration and rollover crashes as well as severe non-penetration, non-rollover crashes is shown in Figure 23. A statistical analysis was conducted on the CG trajectory angle distributions, and a probability curve for the likelihood of penetration or rollover crash results in severe cable median barrier crashes is shown in Figure 24.

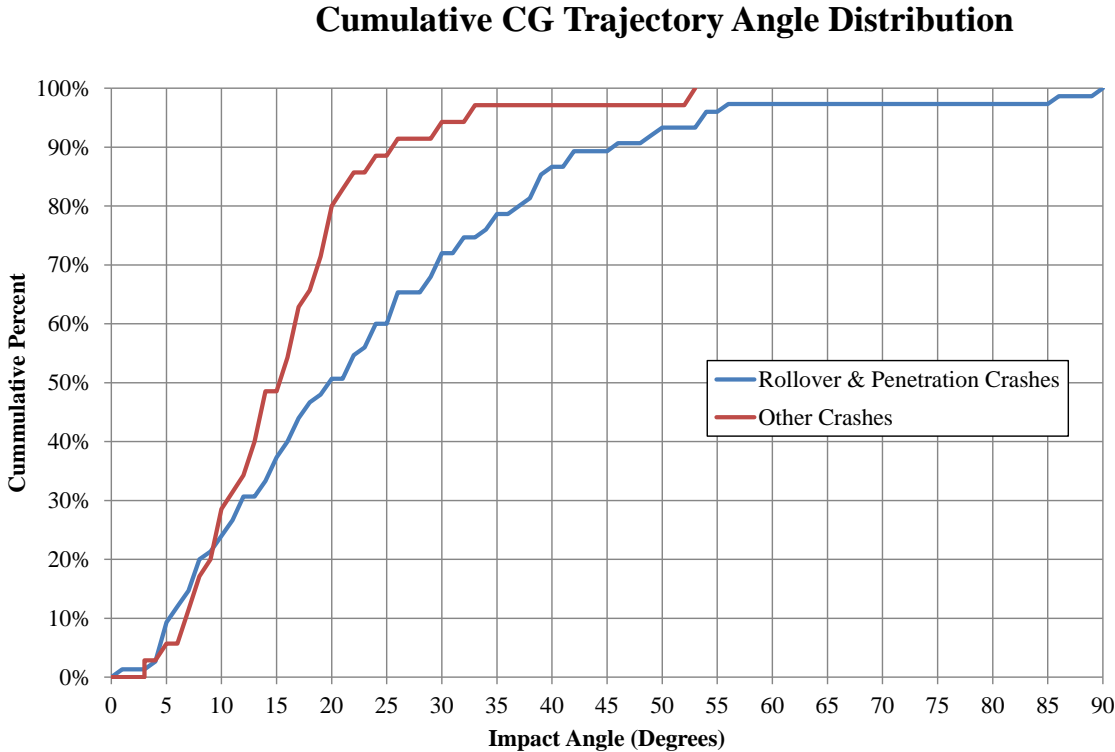

Figure 23. Cumulative Distribution of CG Trajectory Angles by Severe Crash Result

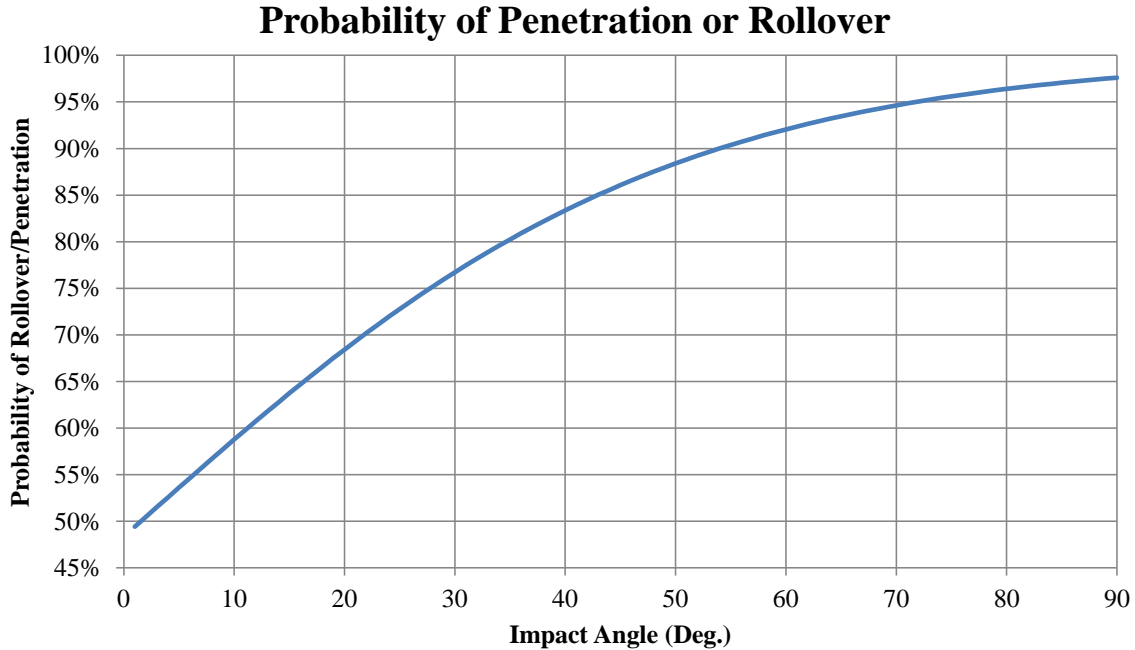

Figure 24. Probability Distribution of Containment Failure in Severe Crashes

In all severe crashes, there was a minimum of a 49% risk of penetration or rollover at very small CG trajectory angles to a high risk of penetration or rollover at large CG trajectory angles. As the CG trajectory angle approached 90 degrees, the risk of penetration or rollover crash results in severe cable median barrier crashes approached 100%, indicating that with a 90 degree CG trajectory angle and a severe crash result, every crash would be expected to be either a penetration or rollover.

4.2.8 Comparison of Missouri and North Carolina

Additionally, a subset of crashes in North Carolina was analyzed, consisting of entirely penetration-related crashes. The penetration crashes were not randomly selected, but typically were investigated in greater detail either when DOT staff saw crash results on newscasts or when crashes were spotted by a field observation team. The investigative teams typically measured median profiles, center-of-cable heights, which side of the low-tension 3-cable median barrier was struck (i.e., side with one or with two cables), tire trajectory marks, and the number of posts

damaged. Researchers were then able to determine departure and impact CG trajectory and orientation angles, and observed a higher number of “backside” penetration crashes, in which the barrier was penetrated more often when struck on the side of the barrier with one supported cable. Photographs were taken of both the vehicle and barrier system involved in the crash.

The subset of crashes investigated, totaling 22 in all, were plotted and compared with the severe crashes in Missouri, as shown in Figure 25. The North Carolina sample also tended toward higher angles than the NCHRP 665 crashes, but the sample size was too small to make judgments about the distribution. Preliminary attempts to determine correlations using chi-squared tests were not statistically significant but trended toward significance (i.e., p values between 0.4 and 0.7), and it is likely that the distributions would be similar if additional data were obtained.

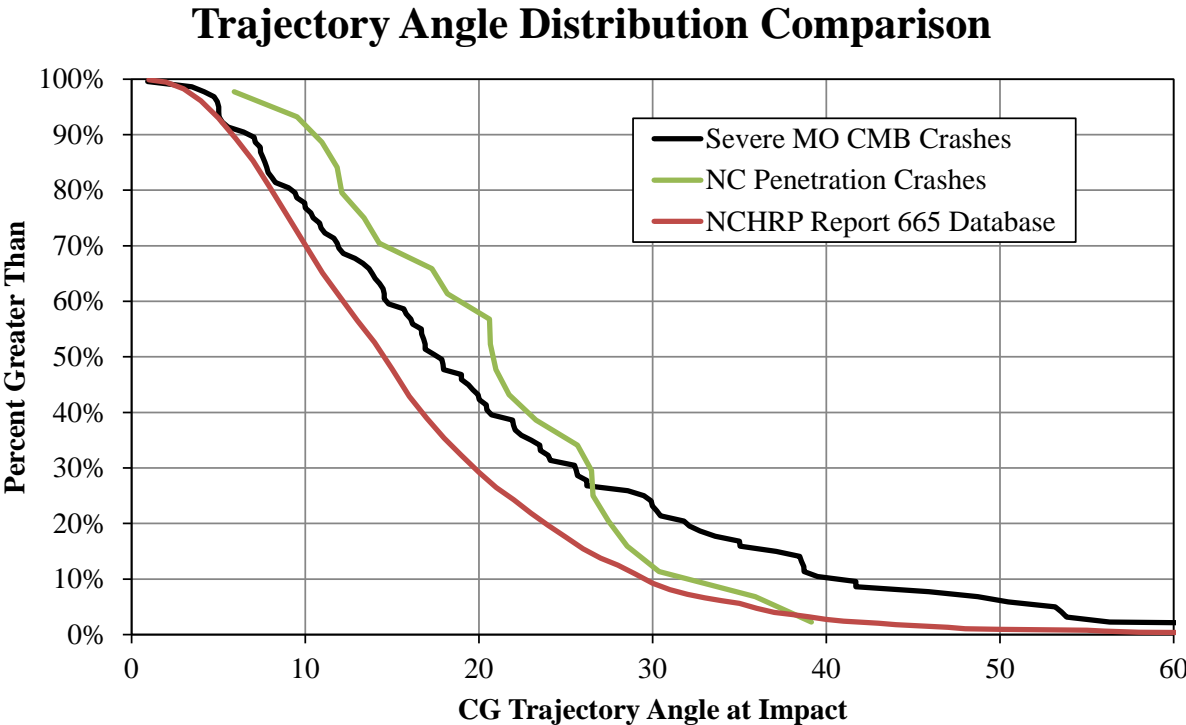

Figure 25. Comparison of North Carolina, Missouri, and NCHRP Crashes

4.2.9 Crash Severity

The relative severity of crashes on each barrier type is shown in Tables 19 through 21. Penetration Severe Crash Contributions (PSCC) and Rollover Severe Crash Contributions (RSCC), along with Penetration Severity Increase Factors (PSIF) and Rollover Severity Increase Factors (RSIF) metrics, were created to evaluate the relative severity risk of each type of crash outcome based on the barrier system. PSIF, PSCC, RSIF, and RSCC metrics are explained on page 63.

The severe crash contribution factors were calculated by taking the ratio of severe penetration or rollover crashes divided by the total number of severe crashes. Both PSCC and RSCC were summed to analyze relative severities. If the sum of PSCC and RSCC approach 100%, it would correspond to a situation in which every severe crash outcome was determined solely by penetration or rollover crash occurrence. If the sum of PSCC and RSCC was low, it would indicate little correlation between crash outcome and crash severity, instead suggesting other factors were more significant to severe crash outcome.

The PSIF was calculated from the ratio of the frequency of severe penetration crashes to the frequency of severe non-penetration crashes. Likewise, the RSIF was calculated from the ratio of the frequency of severe rollover crashes to the frequency of severe non-rollover crashes. In this way, the ratio of the severities of penetration and rollover crashes were determined. As a result, a PSIF of 1.0 corresponded to a case in which the penetration crash had an equivalent risk of severe injury or fatality as a non-penetration crash. The highest average PSIF was 13.2 for low-tension, 3-cable median barrier, and the highest RSIF was 12.0 for the Brifen Wire Rope Safety Fence (WRSF). In general, higher PSIF and RSIF corresponded to lower average severity non-penetration and non-rollover crashes. The aggregate A+K crash severities for each system were reported, even when PSCC, RSCC, PSIF, and RSIF were not available.

Table 19. Crash Severities by System Type and Penetration Crash Outcome

| Injury Severity | Low-Tension 3-Cable Set 1 | | | Low-Tension 3-Cable Set 2 | | | Briden WRSF TL-3 | | | Nucor NU-CABLE TL-3 | | | Trinity CASS 3-Cable | | | | | | | | |
|---------------------------|---------------------------|-------|--------------|---------------------------|------|--------------|------------------|-------|--------------|---------------------|------|--------------|----------------------|------|--------------|-------------------|-------|-----|-----------------|--|--|
| | Crashes | Freq | Penetrations | Crashes | Freq | Penetrations | Crashes | Freq | Penetrations | Crashes | Freq | Penetrations | Crashes | Freq | Penetrations | | | | | | |
| Killed (K) | 3 | 0.4% | 3 | 100.0% | 19 | 0.6% | 10 | 52.6% | 6 | 0.4% | - | 3 | 0.4% | 0 | - | 19 | 1.0% | 7 | 36.8% | | |
| Disabling Injury (A) | 13 | 1.6% | 7 | 53.8% | 25 | 0.7% | 9 | 36.0% | 34 | 2.2% | - | 26 | 3.7% | 7 | 26.9% | 33 | 1.7% | 5 | 15.2% | | |
| Moderate Injury (B) | 59 | 7.4% | 12 | 20.3% | 164 | 4.9% | 33 | 20.1% | 109 | 7.0% | - | 81 | 11.4% | 10 | 12.3% | 125 | 6.4% | 13 | 10.4% | | |
| Slight Injury (C) | 76 | 9.6% | 12 | 15.8% | 462 | 13.8% | 37 | 8.0% | 139 | 9.0% | - | 58 | 8.2% | 5 | 8.6% | 173 | 8.9% | 19 | 11.0% | | |
| Property Damage Only (O) | 644 | 81.0% | 63 | 9.8% | 2688 | 80.0% | 110 | 4.1% | 1263 | 81.4% | - | 543 | 76.4% | 43 | 7.9% | 1593 | 82.0% | 129 | 8.1% | | |
| Severe Crashes (A+K) | 16 | 2.0% | 10 | 10.3% | 44 | 1.3% | 19 | 9.5% | 40 | 2.6% | - | 29 | 4.1% | 7 | 10.8% | 52 | 2.7% | 12 | 6.9% | | |
| Total Applicable Crashes | 795 | - | 97 | 12.2% | 3358 | - | 199 | 5.9% | 1551 | - | - | 711 | - | 65 | 9.1% | 1943 | - | 173 | 8.9% | | |
| CONTRIBUTION | 62.5% PSIF | | | 43.2% PSIF | | | - | | | 24.1% PSIF | | | 3.5 PSIF | | | 23.1% PSIF | | | 2.6 PSIF | | |
| PENETRATION FACTOR | 13.7 PSIF | | | 12.8 PSIF | | | - | | | - | | | 3.5 PSIF | | | 2.6 PSIF | | | 2.6 PSIF | | |

Table 20. Crash Severities by System Type and Rollover Crash Outcome

| Injury Severity | Low-Tension 3-Cable Set 1 | | | Low-Tension 3-Cable Set 2 | | | Briden WRSF TL-3 | | | Nucor NU-CABLE TL-3 | | | Trinity CASS 3-Cable | | | | | | | | |
|--------------------------|---------------------------|-------|-----------|---------------------------|------|-----------|-------------------|------|-----------|---------------------|------|-----------|----------------------|-------|-----------|-------------------|------|-------|-----------------|-------|--|
| | Crashes | Freq | Rollovers | Crashes | Freq | Rollovers | Crashes | Freq | Rollovers | Crashes | Freq | Rollovers | Crashes | Freq | Rollovers | | | | | | |
| Killed (K) | 3 | 0.4% | 0 | - | 19 | 0.6% | - | - | 6 | 0.4% | 1 | 16.7% | 3 | 0.3% | 1 | 33.3% | 20 | 1.0% | 6 | 30.0% | |
| Disabling Injury (A) | 13 | 1.6% | 3 | 23.1% | 25 | 0.7% | - | - | 34 | 2.2% | 10 | 29.4% | 35 | 3.7% | 7 | 20.0% | 35 | 1.7% | 9 | 25.7% | |
| Moderate Injury (B) | 59 | 7.4% | 22 | 37.3% | 164 | 4.9% | - | - | 109 | 7.0% | 13 | 11.9% | 93 | 9.9% | 12 | 12.9% | 130 | 6.4% | 26 | 20.0% | |
| Slight Injury (C) | 76 | 9.6% | 10 | 13.2% | 462 | 13.8% | - | - | 139 | 9.0% | 7 | 5.0% | 64 | 6.8% | 7 | 10.9% | 176 | 8.7% | 13 | 7.4% | |
| Property Damage Only (O) | 644 | 81.0% | 27 | 4.2% | 2688 | 80.0% | - | - | 1263 | 81.4% | 18 | 1.4% | 749 | 79.3% | 7 | 0.9% | 1661 | 82.1% | 44 | 2.6% | |
| Severe Crashes (A+K) | 16 | 2.0% | 3 | 4.8% | 44 | 1.3% | - | - | 40 | 2.6% | 11 | 22.4% | 38 | 4.0% | 8 | 23.5% | 55 | 2.7% | 15 | 15.3% | |
| Total Applicable Crashes | 795 | - | 62 | 7.8% | 3358 | - | - | - | 1551 | - | 49 | 3.2% | 944 | - | 34 | 3.6% | 2022 | - | 98 | 4.8% | |
| CONTRIBUTION | 18.8% RSCC | | | - | | | 27.5% RSCC | | | 21.1% RSCC | | | 7.4 RSIF | | | 27.3% RSCC | | | 7.7 RSIF | | |
| ROLLOVER FACTOR | 3.0 RSIF | | | - | | | 12.0 RSIF | | | 7.4 RSIF | | | 7.4 RSIF | | | 7.7 RSIF | | | 7.7 RSIF | | |

PSIF = Penetration Severe Crash Contribution; ratio of number of severe penetration crashes to number of all severe crashes
 PSIF = Penetration Severe Increase Factor; ratio of percent risk of A+K crash in penetration crashes to non-penetration crashes
 RSCC = Rollover Severe Crash Contribution; ratio of number of severe rollover crashes to number of all severe crashes
 RSIF = Rollover Severe Increase Factor; ratio of percent risk of A+K in rollover crashes to non-rollover crashes

Table 21. Risk Factor Summary for Barrier Systems

| | Low-Tension 3-Cable | Brifen WRSF | Nucor NU-CABLE | Trinity CASS | Gibraltar | Safence (4-Cable) |
|----------------------|------------------------|----------------|-------------------|--------------|-------------|----------------------|
| PSCC | 48.1% | - | 24.1% | 23.1% | - | - |
| RSCC | 22.8% | 27.5% | 21.1% | 27.3% | - | - |
| TOTAL | 70.8% | - | 45.2% | 50.3% | - | - |
| PSIF | 13.2 | - | 3.5 | 2.6 | - | - |
| RSIF | 3.0 | 12.0 | 7.4 | 7.7 | - | - |
| AVERAGE | 8.1 | - | 5.4 | 5.2 | - | - |
| EFFECTIVE A+K | 1.8% | 2.6% | 4.1% | 2.7% | 2.9% | 2.2% |

When data was not available for either rollover or penetration data sets, data subsets were created for each group and the results were compared to the composite totals. For every barrier except the low-tension cable median barrier, the subset distributions were nearly identical to the aggregate. Subsets of the low-tension cable median barrier crash results are compared in Tables 19 through 21.

Although Gibraltar barrier systems were represented in the database, less than 100 total crashes and less than 15 total penetration crashes were available for analysis on the Gibraltar data. Conversely, the Safence database was at the level of statistical significance (295 crashes); however, the number of penetrations was unknown and the uncertainty in the number of A+K crashes in the rollover database was significant; the variation in a single crash at the A+K level would produce 0.4% difference in net A+K rate. Therefore, PSCC, RSCC, PSIF, and RSIF were not calculated for these systems. Additionally, very few Brifen crashes were available for examination with respect to penetration frequencies, which rendered the PSCC and PSIF less useful.

The “effective” A+K rate was obtained by averaging the A+K ratios in the datasets, if average state-level data was available; else, it was equal to the sum of severe crashes divided by the total number of crashes. Since Missouri’s A+K ratio was known, it was included when

calculating the effective low-tension cable median barrier A+K ratio, even though all cable median barrier crashes were not included in the data set.

Based on the metrics created to analyze the crash results, several important but surprising conclusions were made. First, the barrier system with the lowest average severity was the low-tension, 3-cable median barrier system. The maximum state-reported frequency of severe crashes on the low-tension, 3-cable median barrier was 2.0%. Even this maximum number was lower than every other barrier type analyzed in every other state.

Second, rollover severity was higher, on average, on high-tension systems than on the low-tension, 3-cable median barrier. This was unexpected since the low-tension, 3-cable median barriers have the highest rates of rollover of all barrier systems. Although the proportionate number of rollovers was high, these crashes included “tip-overs” in which vehicles made less than 3 quarter-turns. When rollover crashes involved less than 3 quarter-turns, the rollovers were generally low-speed, and as such had a significantly lower risk of severe injury than higher-speed rollovers. The rollover mechanism most commonly associated with low-speed rollovers was contact with post members. Since the low-tension cable median barrier uses the stiffest post in weak-axis bending, it is not surprising that rollovers occurred more frequently, but with lower average severity, than high-tension systems. A more complete discussion of rollover crashes is provided in Chapter 8.

Third, severe penetration and rollover crashes had the highest representation of all severe crashes on low-tension cable median barriers. This indicated that the number of non-rollover, non-penetration severe crashes on low-tension cable median barriers was the lowest of all barrier types evaluated. Alternatively, this statistic indicated that uncontrolled or unknown types of serious injury mechanisms, such as occupant contact with system components or high-exit angle redirection crashes, were minimal.

A closer examination of the non-penetration and non-rollover severe crashes with cable median barriers shows they frequently included occupant contact with posts supporting cables, unbelted occupant ejection, occupant compartment intrusion not caused by penetration or rollover events, and high lateral or longitudinal accelerations due to cable tension. All of these factors were more pronounced in the high-tension cable barrier system crashes than in low-tension system crashes, indicating that increased cable tension may have led to an increase in A+K crashes.

Consideration of barrier placement may explain some of the differences in barrier performance, as well. An analysis on the severity of crashes based on barrier location was conducted in Ohio. Crashes were tabulated based on barrier location in the median as Traffic Side, Center, or Opposite Side positions. Crashes with barriers included in the Center category were within 4 ft (1.2 m) of the center of the median. All installations further than 4 ft (1.2 m) from the median were either classified as Traffic Side or Opposite Side installations, depending on the vehicle's direction of travel. A summary of the performance evaluation of crashes in Ohio is shown in Table 22.

Table 22. Crash Severity by Barrier Location

| Barrier Location | Crashes | Penetrations | Rollovers | A+K Injuries |
|-----------------------------|----------------|---------------------|------------------|---------------------|
| Traffic-Side | 235 | 8.7% | 4.5% | 4.9% |
| Center | 128 | 14.1% | 3.1% | 1.6% |
| Opposite-Side | 494 | 7.7% | 3.8% | 3.4% |
| Traffic- and Opposite-Sides | 729 | 8.4% | 4.3% | 4.4% |

It was determined that the highest crash severity occurred with traffic-side installations, with an effective A+K rate of 4.9%. Barriers installed in the median center had an effective A+K rate of 1.6%, whereas barriers installed on the opposite side had an effective A+K rate of 3.4%. Chi-squared tests conducted comparing the Traffic and Opposite Side crashes to Center crashes

were on the bounds of significance. The p-value of the severe crash comparison was 0.118, which was significant at the 12% confidence level. Comparison of the distribution of penetration and rollover crashes was much more significant, with a p-value of 0.002; this is very statistically significant. Likewise, if the injury distributions were shifted, and A, B, and K injuries were compared, the distributions were statistically different with p-value 0.020, and was statistically significant at the 2% level. Therefore, it can be conclusively determined that the distributions of crashes are not similar, and it is very likely that barriers placed in the center of medians are associated with fewer severe crashes than installations on the traffic- or opposite sides of the roadway. Although it was beyond the level of statistical significance, the analysis also suggested a higher rate of severe crash outcomes with installations placed near either shoulder.

4.3 Discussion

Results from this study were groundbreaking in several facets. To date, few studies were available which have applied a broad cross-section evaluation of any barrier type to determine weaknesses, barrier containment failures, and potential improvements which could be made on the barrier systems. As such, there was little precedent on which to build in this crash study and many recommendations made previously were determined to be less advantageous than originally believed.

With the lack of precedent, surveyed state DOTs could not supply all of the information desired by researchers. No single state could supply a comprehensive data set with crash reports filed by responding emergency personnel and DOT staff, photos of crash scenes, measurements from crash sites, vehicle information, and slope geometries. Most states dedicated effort to assist with individual portions of the data requested even at cost to the state DOTs. The information presented in this report represents the best-effort and broad cooperation of state DOTs pooling information together to solve problems and improve cable barrier safety performance. As a

result, some interpolation and extrapolation was necessary, which introduced uncertainty in the analysis.

4.4 Conclusions

In every state, significant effort was expended to adhere to the current state of knowledge of cable median barrier construction and recommendations at the time of barrier installation [24-26]. It has been frequently re-iterated in roadside safety conversations that barrier installations at or near the shoulder should decrease impact severity; the opposite effect was observed. Most cable median barrier placement guidelines have been developed based on case studies and simulations of cable median barrier impacts, and have led to some important and meaningful conclusions about improper placement and practices. However, in nearly every design simulation utilized by roadside safety research organizations, modeled cable properties were not reflective of actual cable material and physical properties [27]. However, since replacing systems installed on the shoulder could also be cost-prohibitive compared to the safety benefit realized; a better solution would be to improve barrier design for systems installed on shoulders.

Manufacturers also have limited liability with respect to barriers which have already been installed. Every cable median barrier system evaluated in this study was determined to pass NCHRP Report No. 350 crash test standards at the TL-3 impact conditions. Currently, there are no standards or requirements for agencies or states to test barriers to non-standard impact conditions. However, impact conditions which led to an increased propensity for penetration through the barrier or rollover and severe crash results were not consistent with NCHRP Report 350 or MASH crash-testing standards. Oversteering crashes dominated the database, occurring more frequently than even low-sideslip crashes. Since no cable median barrier has been tested with these impact conditions to date, and these impact conditions are not required for a barrier system to be installed in the median of a roadway in the National Highway System (NHS), there

is no meaningful argument that states or barrier manufacturers have acted negligently with respect to any existing barrier installation or barriers currently under construction.

One element of the cable barrier serious crash risk included risk due to motorcycle travel. Motorcycle impacts with cable median barriers have historically caused concern. A study completed in 2011 determined that although motorcycle traffic accounted for approximately 2% of all cable median barrier crashes, over 40% of those crashes were severe [28]. Out of the states with complete data sets in this study, 13 motorcyclists were involved in crashes with cable median barriers, and 10 of those crashes were severe, with 4 fatalities. In Missouri, out of 127 severe crashes, motorcyclists accounted for 3 crashes, or 2.4% of all serious and fatal crash events. Motorcyclist safety will continue to be a concern for roadside safety engineers.

Lastly, it should be noted that high-severity crashes which occurred with barrier systems installed on roadway shoulders were not caused by problems with construction. No cable median barrier installation observed was found to be deficient with respect to manufacturer's installation recommendations, except when some mechanical failures occasionally occurred; however, site-specific analysis was limited to detailed narrative, site drawing, photographic, and scene diagram evidence. Future improvements to cable median barrier designs must be accomplished to realize the maximum safety improvement potential.

5 CASE STUDY OF CABLE MEDIAN BARRIER PERFORMANCE

One distinctive discrepancy in the data set in particular was centered on the Trinity Cable Safety System's (CASS) performance in Utah versus Washington. Both states had a significant number of miles of CASS system installed; yet the rates of penetration on this system were markedly different between the states. In fact, the average rate of penetration due to the combined effects of vehicle underride, override, and rollover on CASS systems in Utah was only 6.1% on a per-crash basis. However, in Washington, the rate of penetration was much higher, with a possible net frequency of 14.5%. Cross-median events in which the vehicle entered opposing lanes totaled 4.6% of all cable median barrier crashes in Washington, and cross-median crashes (CMCs) resulting from cable median barrier penetrations occurred in 2.0% of all CMB crashes. Yet, based on images of barrier installations along Washington and Utah roadways using Google Street View, there were no apparent differences between the states with respect to barrier construction using the C-channel post, and both states rigorously maintained recommended barrier placement guidelines provided by FHWA and research reports. An analysis of the differences between the Utah and Washington results is provided below.

5.1 Weather Conditions

Along the I-15 corridor in Utah, annual snowfall totals can exceed 200 in. (5,080 mm) per year, more than 10 times greater than the state average. Therefore, the precipitation totals along I-15 are much higher than the remainder of the state, as shown in Figure 1. More than 50% of all crashes reported in Utah involved snowfall. This was more than twice as large as the snow representation in Washington. Although some locations in Washington received high snow totals, particularly at higher-elevation locations near the mountains, the majority of the crashes into cable median barriers occurred in coastal regions where snowfall was infrequent. Snowfall tended to decrease both penetration and rollover propensity, whereas frequent rain near cable

barrier locations could contribute to weak post-soil interaction in Washington, increasing penetration propensity.

5.2 Traffic Volumes

Typical ADT counts in Washington on roadways with cable median barriers varied between 20,000 vehicles per day to over 100,000 vehicles per day throughout the state. In Utah, traffic volumes ranged from less than 10,000 vehicles per day to over 100,000 vehicles per day on similar roadways with cable median barriers. More crashes in Utah occurred on roadways with lower traffic volumes than in Washington. The average difference in traffic volumes between crashes in Utah and Washington was over 20%. Furthermore, a larger percentage of heavy trucks were present in Washington relative to Utah. Thus, cross-median and penetration crash events which were not within the design limits of the barrier occurred. Although these crashes were not part of the failure analysis study since these barriers were not designed to withstand impact from larger trucks, these crashes nonetheless contributed to some severe injuries.

5.3 Avoidance Maneuvers

In Utah, most cable barrier crashes were caused by vehicles losing control due to wet, snow-covered, or icy road conditions. Crashes in which the vehicle striking the cable median barrier encountered dry roads and clear weather conditions in addition to being involved in avoidance maneuvers were relatively sparse. For example, the frequency of avoidance-related crashes in Utah was approximately 9.0%, and at least one additional vehicle contributed to the crash sequence in 19.8% of the cable barrier crashes. Although avoidance maneuver statistics could not be obtained for Washington crashes, approximately 37.2% of crashes involved more than one vehicle, which was nearly twice the rate of Utah. This suggests that due to large traffic

volumes, avoidance maneuvers occurred more frequently in Washington than in Utah, and fewer severe crashes occurred in Utah as a result.

Avoidance maneuvers generally resulted in higher CG trajectory and orientation angles because of highly-dynamic, large steering angle motions. These motions can alter a vehicle's travel path and cause a non-tracking skid engagement. As was observed in the Missouri cable median barrier impact angle analysis, high CG trajectory and orientation angles frequently led to severe penetration crash events. The lower number of avoidance-related crashes in Utah indicated that many cable barrier crashes were likely low-angle events caused by loss of control, not avoidance from an adjacent or encroaching vehicle.

5.4 Median Geometries

Medians on Washington roadways frequently ranged between 35 and 50 ft (10 and 15 m) wide. Over 63% of the crashes in Washington occurred with maximum median widths less than 45 ft (13.7 m). In Utah, however, average median widths exceeded 50 ft (15 m) in many sample sites measured from satellite images with map scaling using CAD programs. Some median widths on roadways with cable median barriers installed approached 80 ft (24.3 m).

Cross-median crashes occurred on roads with median widths exceeding 70 ft (21 m), as recorded in the California, Wisconsin, Minnesota, and Missouri studies mentioned previously [2,6,8,12]. By placing a barrier in the median, the barrier impact absorbs some energy from a crash even if a penetration occurs. By decreasing vehicle energy and providing some lateral resistance during impact, the tendency for cross-median crashes to occur on roads with wide medians drops significantly. With this reduction in CMCs, severe crash risks are also reduced.

In Utah, with larger medians and relatively flat slopes (most slopes were between 6:1 and 10:1), a higher proportion of impacts occurred on the median slopes with lowest risk of penetration than in Washington, based on the median slope results shown in Figure 6. Site-

specific estimates in Washington indicated that the roads with the highest rates of penetration were sites with either fairly flat (i.e., flatter than 8:1) or steep (i.e., greater than 6:1) median slopes. The two roads with the lowest rates of penetration had estimated slope rates of between 6:1 and 8:1 over much of the protected length, and much of that roadway was at 8:1.

5.5 Barrier Placement

Cable median barriers were also frequently placed near the edge of median shoulders in Washington, adjacent to the travel lanes. In Utah, many cable median barrier installations were located in the median, either 1 ft (0.3 m) or 8 ft (2.4 m) from the ditch centerline, or up to 16 ft (4.9 m) from the road. Barrier installations near the ditch center can reduce the number of nuisance hits by allowing an opportunity for vehicles to correct from errant maneuvers. When vehicles are engaged in avoidance maneuvers, CG trajectory angles tend to increase relative to the barrier proportionately with the distance between the travel lanes and the barrier installation. During loss of control, however, vehicle speeds at impact were typically lower when barriers were far from the roadway due to heavy braking and skidding.

Swerving, avoidance, or over-correcting maneuvers in Washington caused more vehicles to strike the barrier at higher orientation angles and CG trajectory angles. Barriers located on the shoulder permitted the vehicle striking the barrier from adjacent travel lanes to pry under or override the cables, and vehicles impacting from the opposite direction to pry underneath or launch over the barrier. Crash outcomes depended on the impact angles, impact speeds, slope rates, and vehicle profiles.

5.6 Conclusions

As a result, it was reasonable to assume that the average impact CG trajectory angles and speeds during cable barrier impacts in Washington were higher than the average impact CG trajectory angles and speeds in Utah. This determination was based on the frequencies in snow-

related crashes, as well as differences in median widths, traffic volumes, and the number of lanes on each roadway where crashes occurred. Similar arguments can also be provided for many of the states participating in this study.

However, Washington provided a tabulated list of only whether or not a rollover occurred, as well as the maximum injury level sustained in a crash, in lieu of which vehicle rolled and which vehicle had the highest severity. Rollovers occurred in 12% of all crashes involving more than one vehicle in Washington, and data from other states suggest that in at least 15% of multi-vehicle crashes involving cable median barriers, and possibly up to 30%, the vehicle which does not strike the cable median barrier was involved in the rollover. This could reduce the actual rate of rollover on Washington systems by 1.8% to 3.6%. Similarly, multiple vehicles were involved in most of the severe crashes in Washington. Approximately 1.5% of all Washington crashes were A+K crashes not involving head-on collisions with vehicles in opposing travel lanes. Approximately 20% of the non-cross-median serious crashes in which multiple vehicles were involved should not have been classified as serious crashes, due to the higher injury severity to an occupant in the vehicle which did not strike the barrier than in the vehicle which did. Accounting for this adjustment, the average rate of severe crashes caused by the cable median barrier would be reduced to 2.1% in Washington, which compares favorably with all other states in this study. Unfortunately, these adjustments cannot be made on the individual case level, which could affect one installed system to a greater degree than another.

However, none of the aforementioned factors should increase liability to the state of Washington or any other state participating in this study. As stated, this study was foundational, and the recommendations provided in this research establish a precedent for future research. Barrier installations already constructed or in construction prior to the publication of this report

cannot be treated with the same scrutiny as future barrier installations. Benefit-to-cost analyses are required to provide improved guidance in the future changes to policy and construction.

For example, expanding median widths and regrading medians of established roadways can often be impossible due to constraints on the right-of-way, drainage, and prohibitively large construction costs in these locations. The benefit-to-cost ratios of many of these efforts are often much less than 1. Future construction projects may not have a sufficient budget to address these needs as well. Furthermore, no median slope was “immune” to either penetration or rollover crashes; only a minimization was observed. Instead, it is generally desirable that modifications can be made to existing cable median barrier systems to improve performance regardless of placement or median slope rate, since this generally has a lower net cost to the state and a higher propensity for better overall barrier performance.

6 CAUSES OF CABLE MEDIAN BARRIER PENETRATIONS

Unlike rollovers, cable median barrier penetrations were heavily dependent on which type of system was struck. Penetration mechanisms were heavily dependent on the mechanics of barrier deformation and cable release. In order to describe the mechanisms of penetration, system details for the Nucor NU-CABLE TL-3 3-Cable System, C-Shaped post and S-Shaped post Trinity Cable Safety System (CASS) TL-3 Systems, Brifen Wire Rope Safety Fence (WRSF) TL-3 4-Cable System, and the TL-3, low-tension, 3-cable median barrier system are described below.

6.1 System Design Details

6.1.1 Nucor NU-CABLE TL-3 3-Cable System

The cable-to-post attachment used by Nucor was very strong compared to all other barrier systems, and is shown in Figures 26 through 29. This cable-to-post attachment is also used in the Trinity CASS barrier, near the end anchorages and terminations.

The clips were fastened to the post by inserting the bent upper leg into the appropriate hole on the flanged U-channel, and then were locked in place with a nut threaded onto the bottom clip threads. Holes in the flanges were spaced approximately 1 in. (25 mm) on center vertically through the centerline of the flange. Many posts were 4 lb/ft (6 kg/m) flanged U-channel with Rib-Bak construction, though some installations utilized the 5 lb/ft (7 kg/m) posts. The median barrier configuration for this post utilized two short clips, shown in Figure 29, for the top and bottom cables, and one long clip, shown in Figure 28, to support the middle cable.

Since the attachment had a 60 ksi (414 MPa) minimum ultimate strength requirement, the resulting minimum tensile load required to cause rupture of the shank was 4.6 kip (20.5 kN) through a single leg. The clip appeared to be designed to dissipate energy through the bending deformation of the upper leg of the clip. During vertical pullout loading conditions, the curved

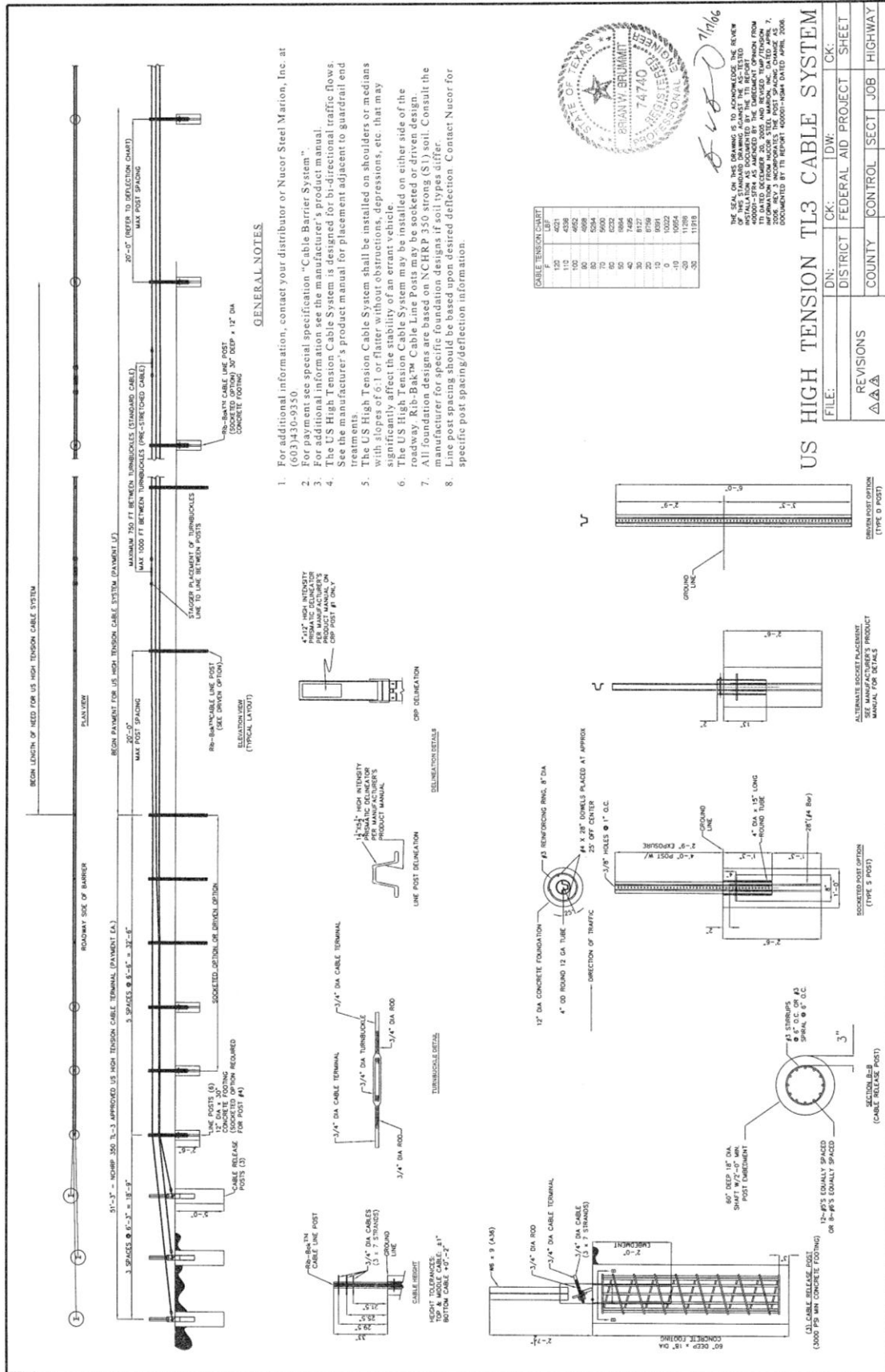

Figure 26. Nucor Cable Barrier Design Details [29]

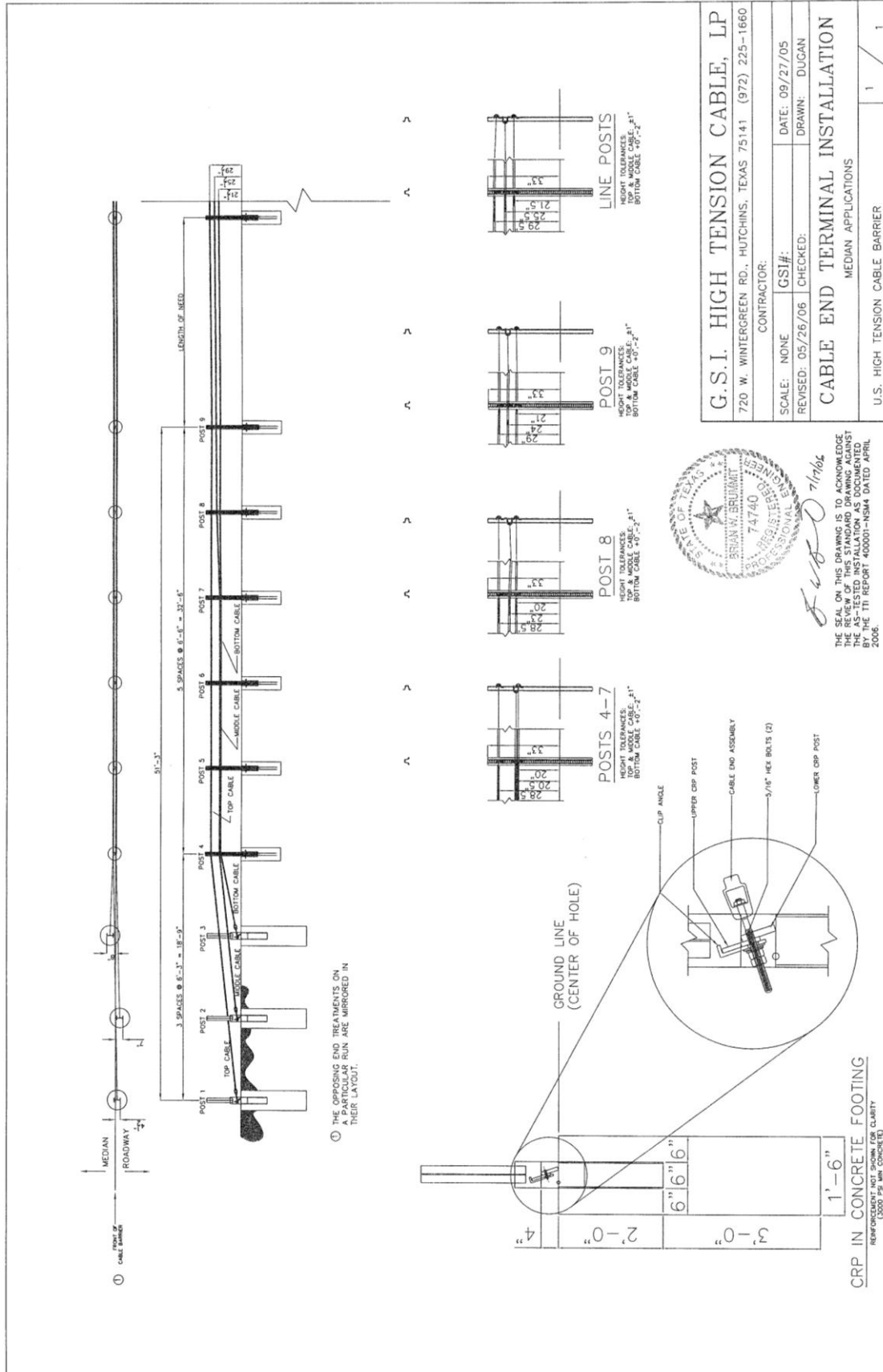

Figure 27. Nucor Cable Barrier Design Details [29]

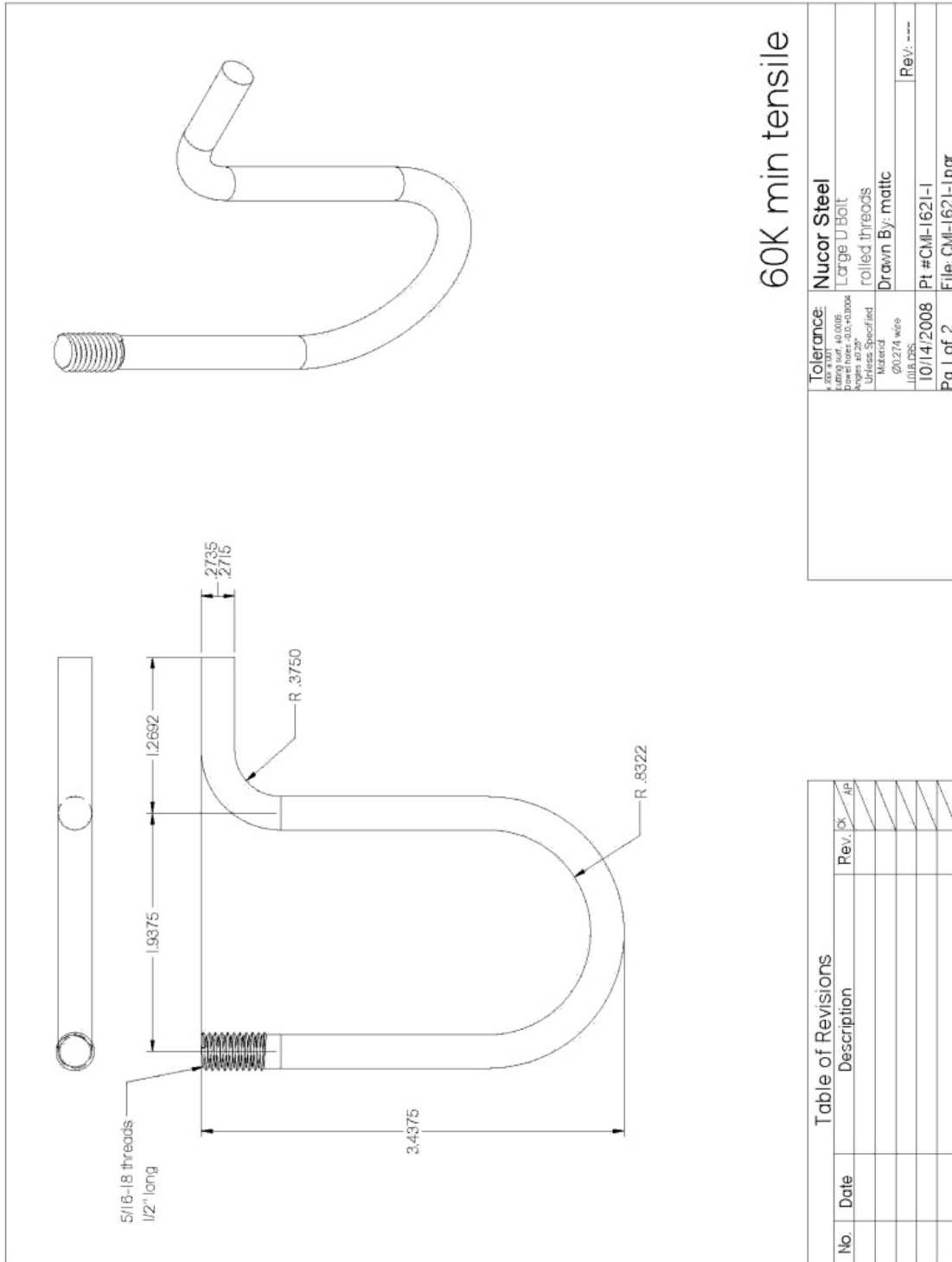

Figure 28. Nucor Cable Barrier Long Clip Design Details [30]

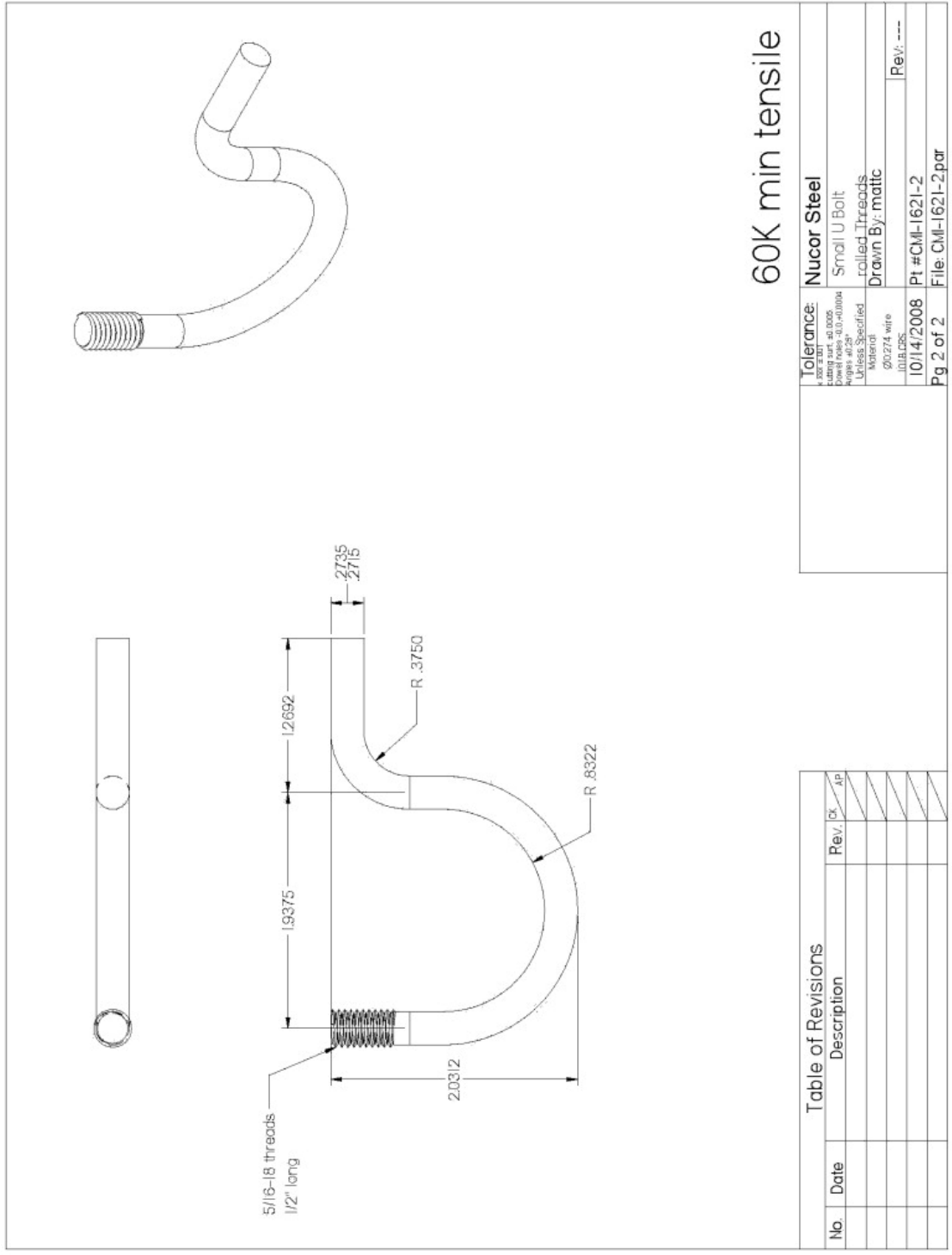

Figure 29. Nucor Cable Barrier Short Clip Design Details [30]

clip construction contributed to friction wedge locking of the bent leg in the top hole. Due to vertical forces, the moment couple applied to the clip tended to aggravate the locking tendency. A schematic of the vertical release problems identified is shown in Figure 30. The friction lock prevented the upper leg from bending and releasing from the post, frequently resulting in large applied tensile loads carried by both legs of the clip until the clip fractured, the post was pulled vertically out of the ground or post socket, or the post fractured. The vertical loading resulted in post pullout in most crashes.

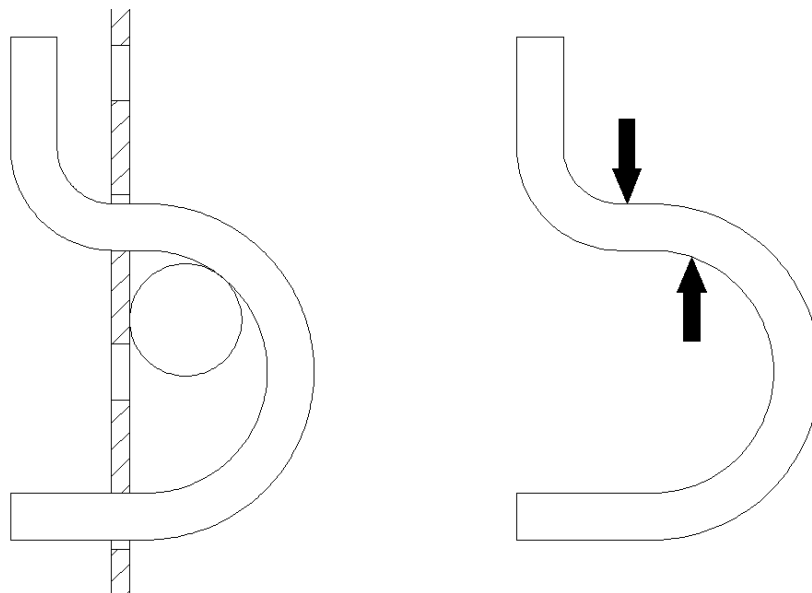

Figure 30. Vertical Pullout Moment Couple on Nucor Cable-To-Post Attachment

Although the clip would perform adequately in horizontal pullout with stiff posts, the flange-channel U-post does not have the rigidity necessary to resist bending and buckling or fracture. During horizontal pullout loading, the post deflected with the cable load, and the horizontal load applied transitioned to a mixed horizontal and vertical loading. As the loading transitioned to vertical pullout, the posts were again pulled upward and out of the ground or fractured in many crashes. Relatively few crashes were observed in which the cable-to-post attachments released as intended.

6.1.2 Trinity Cable Safety System (CASS) 3-Cable Barrier

In addition to the Nucor TL-3 3-cable barrier on flange-channel posts, the Trinity CASS 3-cable barrier installed on C-shaped posts had a large installed base in the United States. CASS installations were present in such states as Iowa, Ohio, Oklahoma, Utah, and Washington, as well as many others. Details of the C-channel and S-post versions of the TL-3 CASS system are shown in Figures 31 through 34.

Most of the Trinity CASS system installed in the participating states utilized the TL-3 C-shape post sections. Some mileage was identified of both the TL-4 and TL-3 S-shape post section barrier designs. However, relatively few crashes occurred on the TL-4 design.

The direction of the channel in the C-shaped posts was alternated, per construction design. As a result, the radius of gyration to the weak axis was different when the posts were struck on the channel or continuous sides. Alternatively, the S-shape posts were comprised of S4x7.7 (S102x11.5) shape sections, with two $1^{1}/_{16}$ -in. (17-mm) holes in each flange. Researchers estimated that weakening holes decreased the strong-axis section modulus from 3.03 in.³ to 2.54 in.³ (49,652 mm³ to 41,623 mm³), and decreased the weak-axis section modulus from 0.562 in.³ to 0.368 in.³ (9,210 mm³ to 6,030 mm³). By comparison, a standard S3x5.7 post has a strong-axis bending modulus of 1.67 in.³ (27,366 mm³), and a weak-axis bending modulus of 0.383 in.³ (6,276 mm³).

All of the cables in the Trinity CASS systems were located in a slot in the top of the post. Cable spacers and retainers were used to prevent the cables from slipping out of the posts in nuisance impacts. A sleeve tie was also used to retain the lower cable with a higher vertical release load and to stiffen the flanges where the web was cut. Driven and socketed options were available. The S-post TL-3 system had cables mounted at 29½, 25³/₁₆, and 20⁷/₈ in. (749, 640, and 530 mm) and are shown in Figure 33. Cables in the TL-3 C-shape post system were $1/_{16}$ in.

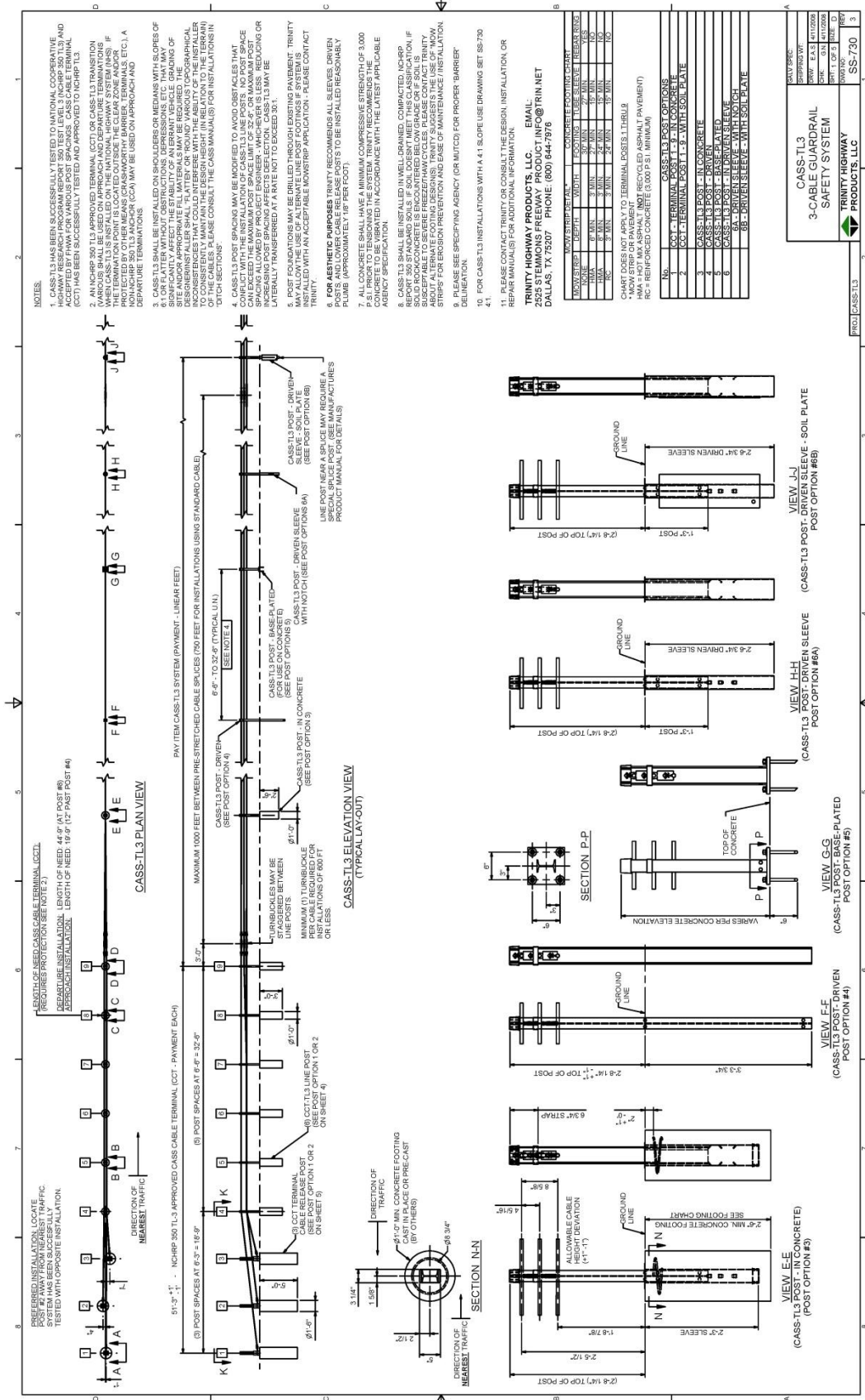

Figure 33. Trinity CASS TL-3 S-Post System Details [32]

(2 mm) lower than in the S-post system. The TL-4 system had cables mounted at $38\frac{1}{8}$, $29\frac{1}{2}$, and $20\frac{7}{8}$ in. (968, 749, and 530 mm).

A common cause of penetration in the CASS database occurred when the vehicle struck a post before striking the cable barrier system. Since the vehicle applied no loads to the cable at the time of impact, the only lateral load on the cables was caused by the posts; however, due to post deflection, the cables were forced down in the slot and could not release from the post and engage the vehicle, contributing to many override containment failures of even passenger cars. This type of cable entrapment will always occur when cables are located within a post slot. This form of cable entrapment was referred to as a “ramp formation” override penetration. As a result, this system may be intrinsically susceptible to cable entrapment and ramp formation override penetrations unless barrier modifications to prevent cable entrapment can be made.

6.1.3 Brifen TL-3 Wire Rope Safety Fence (WRSF)

The TL-3 Brifen WRSF is typically comprised of proprietary Z-posts with rollers supporting the cables vertically, as shown in Figures 35 through 37. Virtually all Brifen systems utilize ground sockets for easy post replacement, though a post with soil plate option was also available. Four cables are used in the system, with one cable woven around the posts and mounted at $19\frac{1}{2}$ in. (495 mm), two cables cross-woven and mounted at 26 in. (660 mm), and an additional cable in a slot cut in the top of the post, mounted at $28\frac{3}{8}$ in. (720 mm).

Typically, plastic retainer caps were used to retain the top cable in the Brifen WRSF. Other cables were constrained by the interaction with adjacent posts. For each of the middle and lower cables, vertical rise was only resisted by friction, whereas the lower roller supported the cable from being pushed down by the impacting vehicle. Because of the cable weave, the Brifen cables often sagged after a moderate-speed crash into the system in which more than two posts were disengaged from the cables. The weave significantly reduced average dynamic deflections

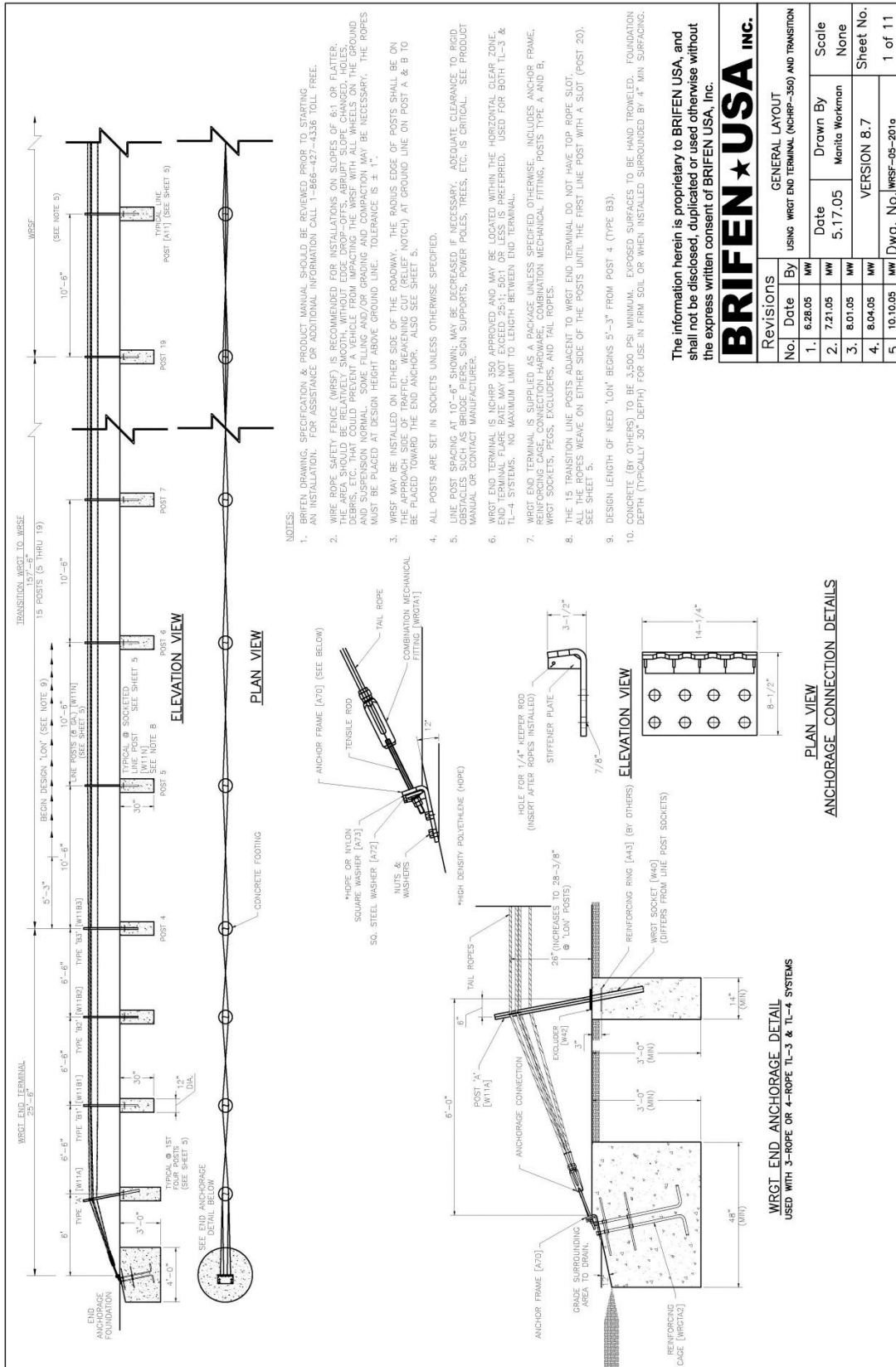

Figure 35. Typical TL-3 Brifen WRSF Design Details [34]

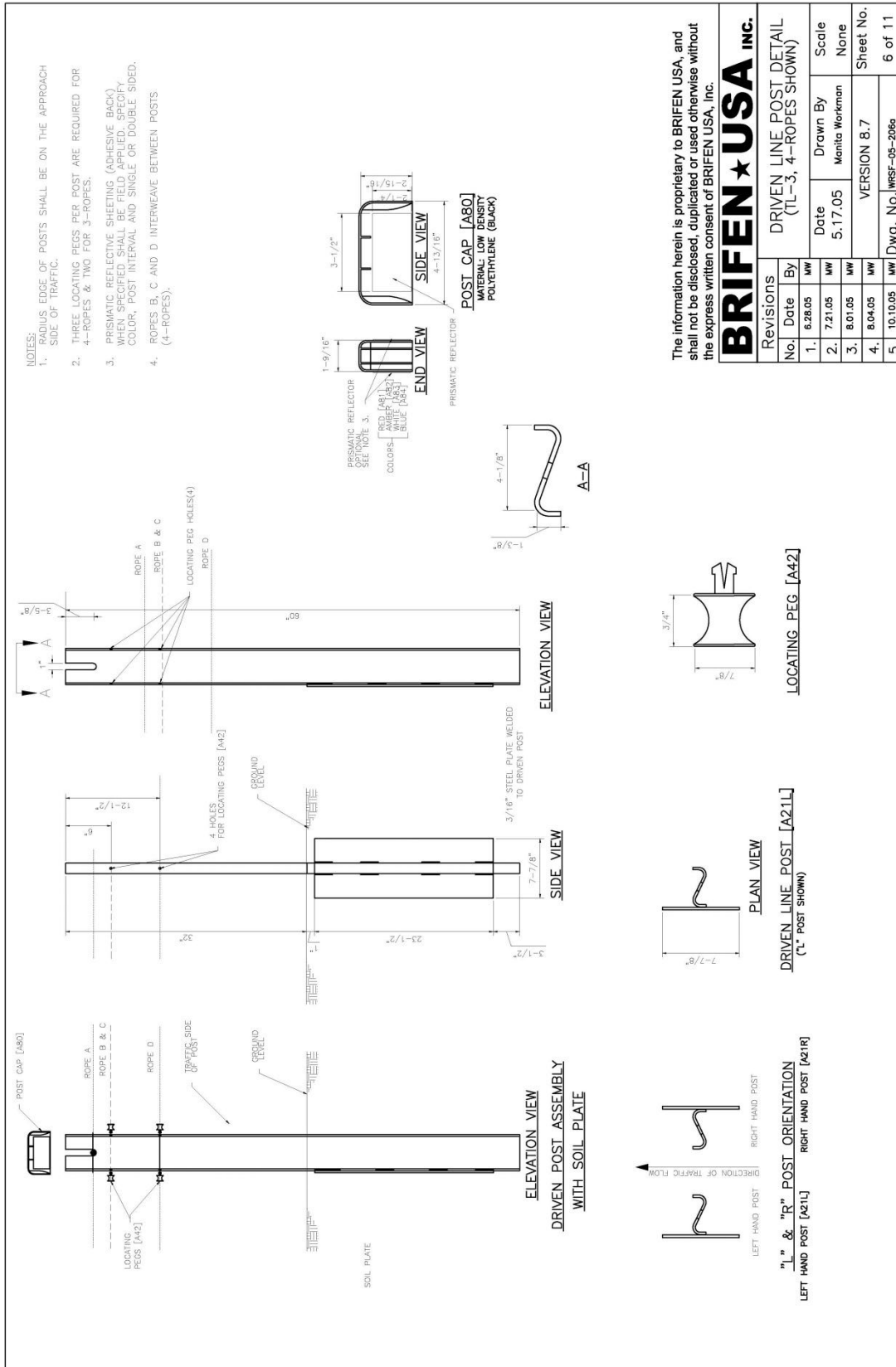

Figure 36. Typical TL-3 Brifen WRSF Design Details [34]

and provided a smooth ridedown deceleration, but the system was susceptible to both rollovers and underride penetrations. Rollovers were frequently associated with wheel entrapment by the lower woven cable. Underride penetrations were frequently caused by vehicles prying the bottom cable upward, which had low vertical resistance. These factors will be discussed in greater depth in Chapters 7 and 8.

6.1.4 Low-Tension, 3-Cable Median Barrier

Several low-tension, 3-cable median barrier designs have been tested and were originally approved by FHWA according to TL-3 crash conditions in NCHRP Report 350. The low-tension cable median barriers involved in crashes in this study were similar.

The low-tension, non-proprietary 3-cable median barrier was developed through testing and evaluation by several state DOTs, including New York and Washington [e.g. 35-36]. Several other states have installed many miles of low-tension cable median barrier, and in North Carolina and Missouri, the combined length of barrier exceeded 1,400 miles (2,253 km). It was estimated that the low-tension, non-proprietary 3-cable median barrier currently accounts for more than 40% of the cable median barrier mileage installed in the United States, though the exact percentage is unknown.

The low-tension, 3-cable median barriers installed in Missouri, Washington, and North Carolina were very similar. Examples of North Carolina's low-tension, 3-cable median barrier standard plans implemented in 2002 are shown in Figures 38 through 43. In each of the low-tension, non-proprietary designs, tension spring compensators were used to retain tension in the cables during very warm weather and to prevent excessive tension increases during very cold weather. The cables were tensioned to between 900 and 950 lb (4.0 to 4.2 kN) at approximately 70°F (21°C), and frequently used wedge splitter cable splice connections, as shown in Figure 41. End anchors for these designs frequently used the end terminal developed by New York,

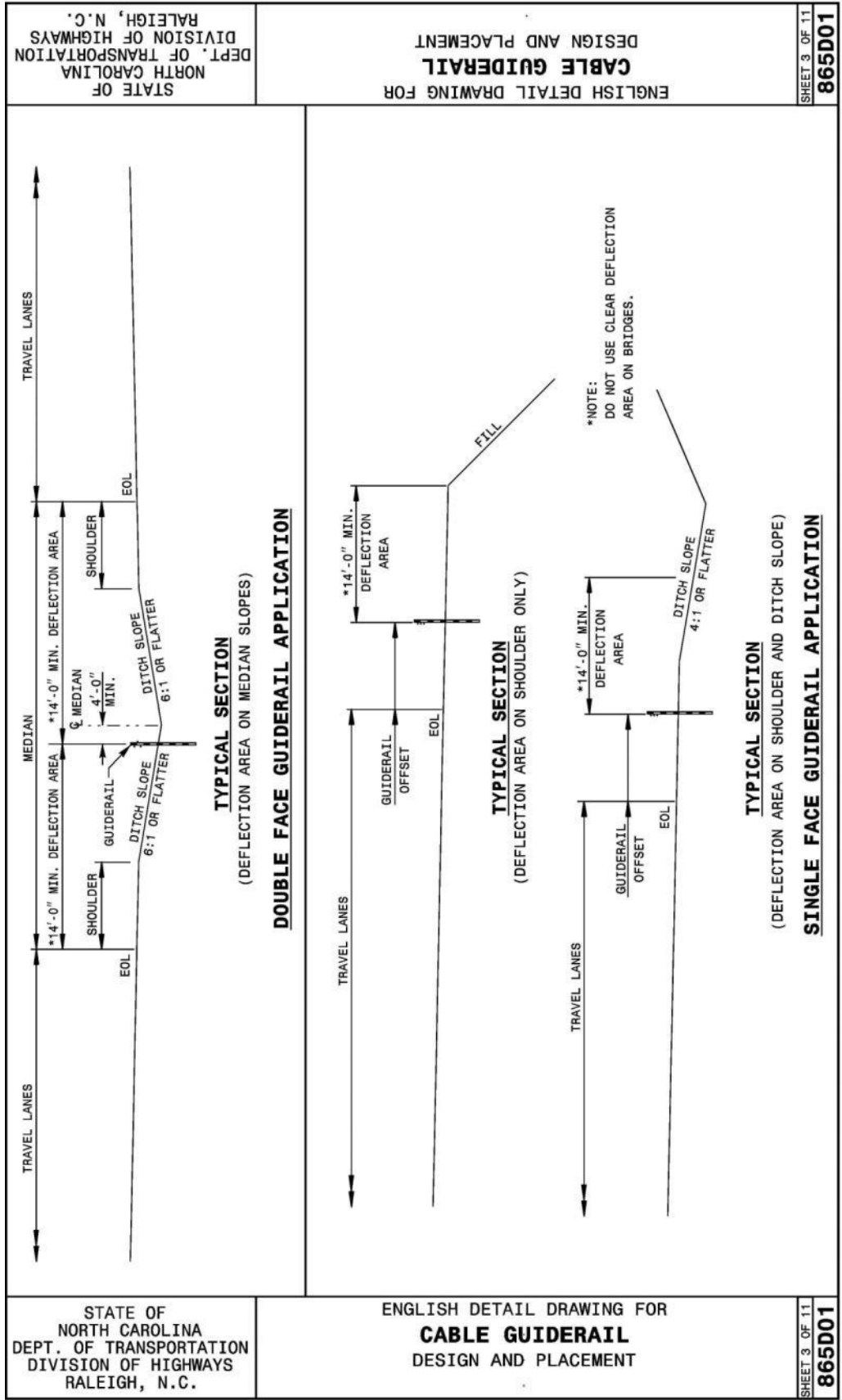

Figure 38. Low-Tension 3-Cable Median Barrier Standard Plans, North Carolina DOT, 2002

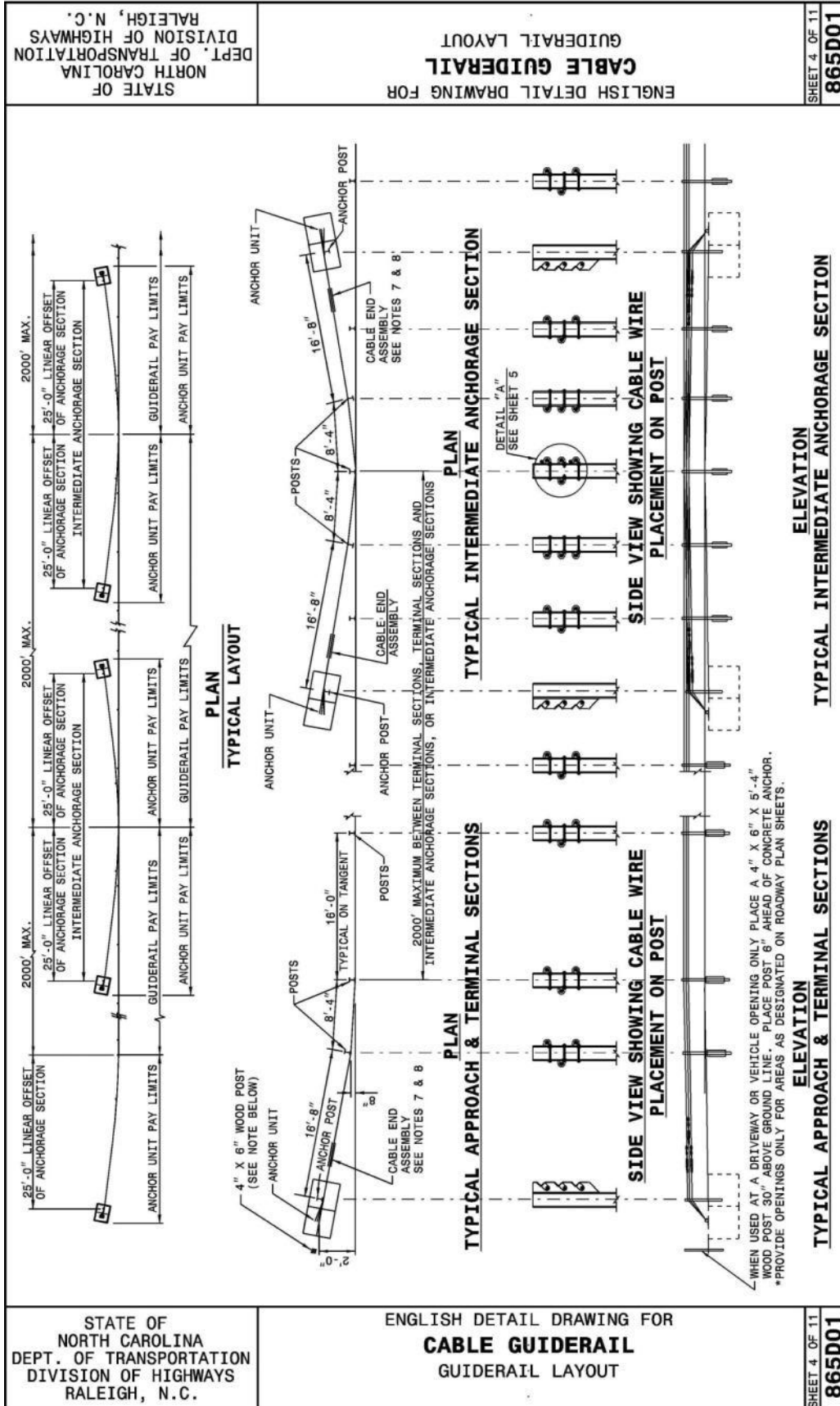

Figure 39. Low-Tension 3-Cable Median Barrier Standard Plans, North Carolina DOT, 2002

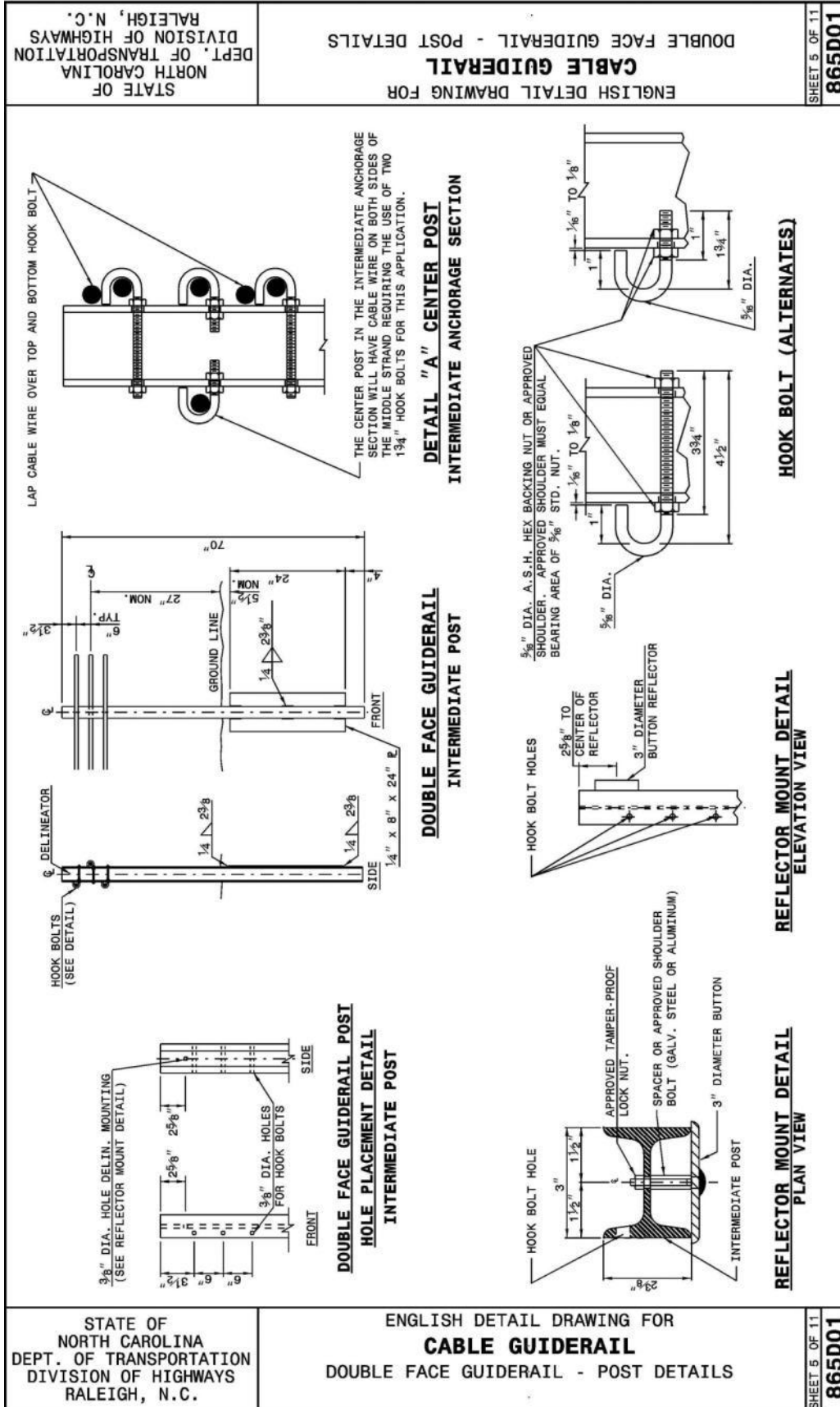

Figure 40. Low-Tension 3-Cable Median Barrier Standard Plans, North Carolina DOT, 2002

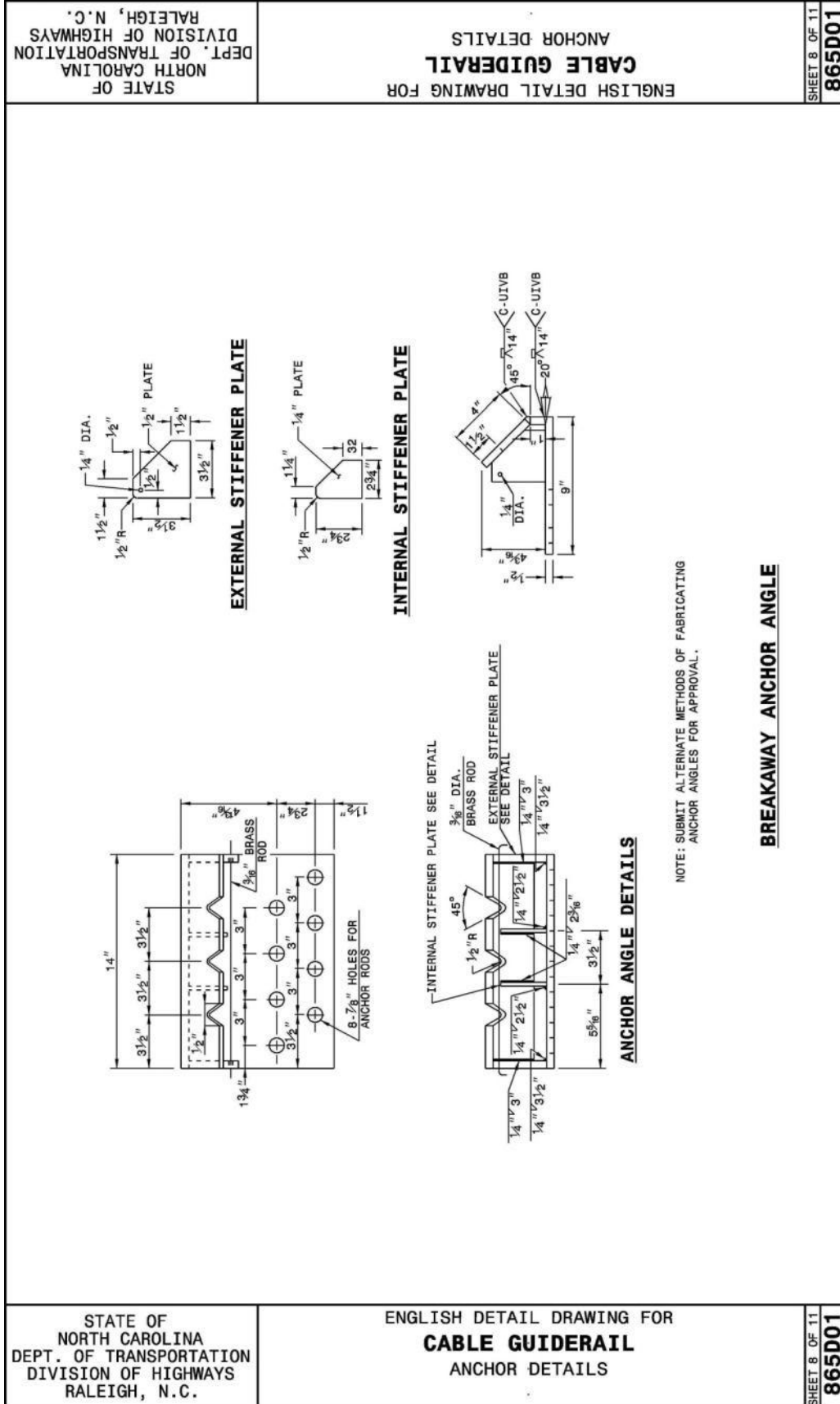

Figure 41. Low-Tension 3-Cable Median Barrier Standard Plans, North Carolina DOT, 2002

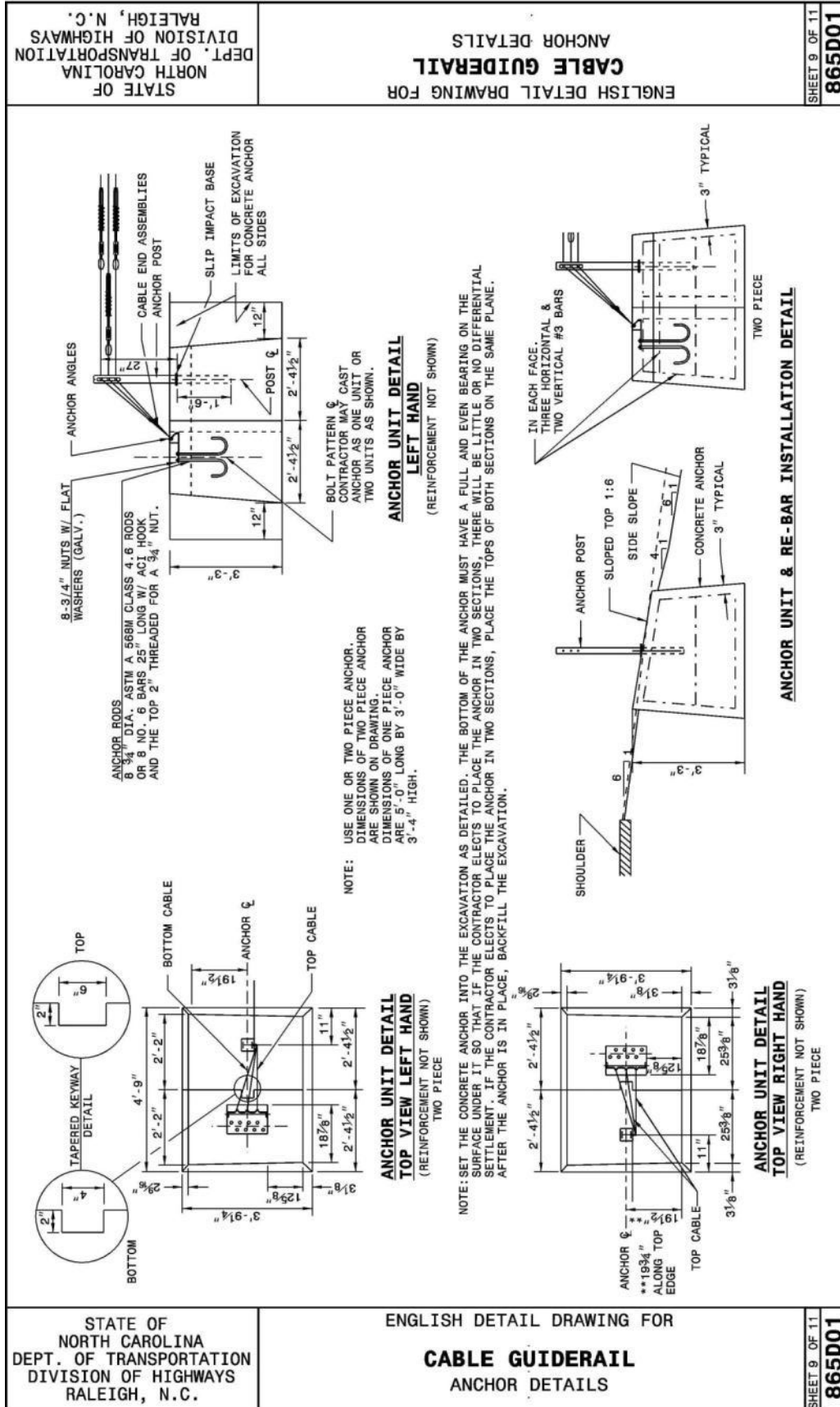

Figure 42. Low-Tension 3-Cable Median Barrier Standard Plans, North Carolina DOT, 2002

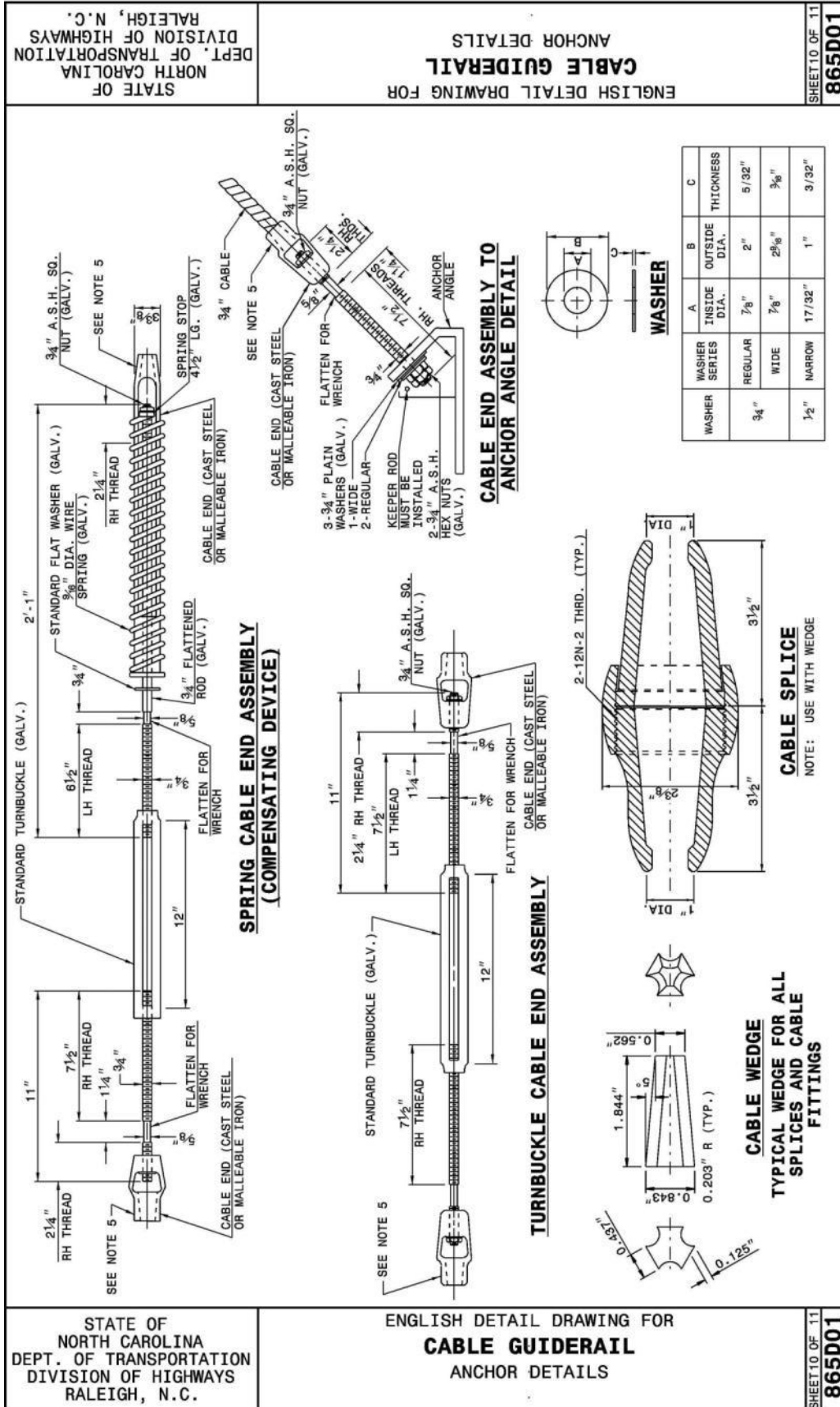

Figure 43. Low-Tension 3-Cable Median Barrier Standard Plans, North Carolina DOT, 2002

which was approved under the guidelines presented in NCHRP Report 350 [37]. North Carolina later modified the standard cable median barrier plans in 2006 to address penetration concerns after conducting some performance improvement studies [38].

6.2 Overview of Crash Data

Based on the statistical analysis presented, the crash data was categorized by system type, though each crash was investigated independently. The types of containment failures in each cable median barrier crash were determined using scene diagrams, narratives, vehicle damages, and photographs when available. When the cause of the penetration crash could not be identified, the case was excluded from further analysis.

A total of 213 crashes with determinable causes of penetration were identified. Seven primary causes of vehicular penetrations were identified and tabulated, as shown in Table 23. One of the categories, “Large Vehicle”, incorporated medium to heavy trucks, including double-rear axle single-unit trucks, buses, tractor-trailers, tank-trailers, construction vehicles, and other similar vehicles which have dimensions and weights beyond what has been typically tested on TL-3 cable median barrier systems. However, because this type of failure was linked only to vehicle type, every penetration crash with a vehicle conforming to this class was designated as a “Large Vehicle” penetration. Because this failure type was linked only to vehicle type and the scene diagram, narrative, and vehicle damage were not necessary, a disproportionate number of Large Vehicle crashes were identifiable relative to other penetration failure types.

The causes of penetration-related cable median barrier containment failures are shown in Table 23. The failure causes shown in Table 23 were not intended to demonstrate relative frequencies of penetration crash types between systems. Many of the penetration crashes did not have determinable causes. The purpose was to demonstrate the types of failures which were discernible per each system type to observe general trends in the data. Unfortunately, systems

such as Gibraltar and Brifen, despite having a fair representation in the total database, had very few discernible causes of penetrations due to the lack of available scene diagrams.

Table 23. Causes of Penetrations

| Penetration Contributor | Description | Number of Penetrations Recorded | | | | | |
|-------------------------|---|---------------------------------|-----------|----------|-----------|-----------|------------|
| | | Nucor | CASS | Brifen | Gibraltar | Generic | Total |
| Diving | Front end of vehicle protrudes beneath cables and lifts cables up and over the hood. This condition is most common with passenger cars. | 10 | 2 | 1 | 1 | 22 | 36 |
| Prying | Vehicle protrudes between or below cables and pries the cables away from the system due to the slope of the vehicle body, resulting in either underride or through-cable penetration. | 20 | 26 | 5 | 1 | 30 | 82 |
| Override | Wheels of vehicle pass over the top of the cables, forcing them below the undercarriage. This category includes launching but excludes rebound off of slopes which causes override. | 27 | 26 | 1 | - | 8 | 62 |
| Bounce-Over | Specific to rebounding off of slopes; vehicle strikes ditch and rebounds up and over the barrier due to suspension compression and unloading. | - | 2 | - | 1 | 1 | 4 |
| System Failure | Penetration caused by a breakdown of system components, design, or installation, either releasing tension in the cables or eliminating post contributions. | - | - | - | - | 2 | 2 |
| Large Vehicle | Tractor-trailers, buses, large trucks, camper vehicles, and construction vehicles. No cable barrier is currently designed for these types of impacts; however, these impacts are frequently severe. | 5 | 7 | - | 1 | 8 | 21 |
| Total | | 62 | 63 | 7 | 4 | 71 | 207 |

Furthermore, many states had a significant number of miles of one particular barrier type installed. This contributed to some additional uncertainty due to roadside design practices utilized in each state. For example, median widths in Ohio routinely exceeded 50 ft (15.2 m), and barriers on relatively shallow slopes were typically installed either at or near the center of the ditch or near the shoulder slope break point. As a result, very few crashes would result in a “bounce-over” type of failure, since “bounce-over” crashes involve vehicles rebounding vertically after bouncing on changes in the median slope.

Similar constraints affected the Brifen system overall. The only crashes applicable in this study involved barriers located in wide medians or adjacent to shallow slopes, effectively eliminating any opportunity for a “bounce-over” impact to occur. Although no “bounce-over” impacts were observed on the Brifen, Nucor, or Safence systems, there is currently no proprietary or non-proprietary design which is not susceptible to “bounce-over” failures.

Most of the impacts in the database occurred with 3-cable barrier variations of each system type, with standard hardware and cable spacing. A total of 18 crashes occurred in the state of Ohio with a 4-cable Nucor barrier, which was the only TL-4 system involved in crashes which had available scene diagrams and supporting photographic evidence to determine the causes of failure. Two penetrations and two rollovers occurred in two crashes on this system. In one crash, barrier penetration contributed to a rollover. In a separate crash, the rollover caused the vehicle to override the barrier.

Although the causes of barrier containment failures were mutually exclusive, contributing factors to the failures were not. Three domains of cable barrier containment failure factors were identified: system-dependent factors, installation-dependent factors, and vehicle-dependent factors. Of these domains, the system-dependent and installation-dependent failures will be discussed in detail in Chapter 7. A brief summary of typical conditions associated with each type of penetration factor is provided below.

6.3 Types of Penetrations

6.3.1 Diving Penetrations

Diving-type penetrations were defined as crashes in which the median geometry caused suspension compression, causing the leading edge of the vehicle bumper to dive below the bottom cable and lift all of the cables above the bumper and onto the hood. Diving penetrations were characterized by mechanical levers: once the impacting corner of the vehicle protruded

under the cables, prying action through the longitudinal axis of the vehicle lifted the cables up in the same manner as a long tree limb pulled at a sufficient distance can lift or displace a boulder.

Diving failures were not restricted to particular vehicle classes. Examples of vehicle makes involved in diving crashes included a Saturn Aura, Mitsubishi Galant, Ford Fusion, and Ford Mustang. These vehicles did not conform to any identifiable front-end patterns except that the height of the leading edge of the hood was not “large”, or were all below approximately 27 in. (686 mm) when the vehicle was at rest. Other underride penetration types were heavily dependent on the geometry of the impacting vehicle.

6.3.2 Prying Underride Failures

In prying-type underride penetrations, cables were pried up above the hood, thus allowing the vehicle to pass under the cables. The prying differentiation was used to separate crashes which did not heavily depend on median terrain; any underride containment failure occurring on a flat shoulder adjacent to the travel lane was therefore a prying-type penetration. As a result, crashes with prying underride penetrations had a strong correlation with the vehicle impact orientation angle and vehicle shape.

Prying penetrations were analogous to mechanical wedges, which can split logs when struck with enough force. Analogously, for low-angle prying events, the prying action is similar to a “seesaw”, in which a small child located far from the fulcrum can lift an adult, similar to the way that motion of the rear of the vehicle can cause prying on the front corner or vice-versa. Both diving and prying penetrations shared similar failure mechanisms. However, median geometries and vehicle types varied widely between the two containment failure datasets, prompting researchers to treat each type independently.

Non-tracking skid crashes, in which the entire side of the vehicle was engaged with the cable, barrier frequently resulted in adequate vehicle capture and low risk of rollover.

Conversely, engagement along the front or rear planar surfaces of the vehicle frequently resulted in penetrations.

During high-orientation angle impact conditions, the vehicle engaged the barrier in a condition which may promote cable separation, lifting, or compression. The increased risk to impacting vehicles was due to a combination of the following factors: (1) vehicle stiffness prevented the cables from creating “furrows” or grooved contact patches on the vehicle, which tended to retain the cables throughout impact; (2) the “approximate equivalent” vehicle profile which came into direct contact with the barrier system changed; and (3) vertical motions of the front or back of the vehicle were exaggerated relative to cable motion at orientation angles approaching 90 or -90 degrees.

6.3.3 Bounce-Over Penetrations

A bounce-over penetration was a specialized crash event in which the impacting vehicle rebounded off a median slope and passed over the top of the barrier system. This type of crash is more common with smaller passenger vehicles since large vehicles more frequently “dig in” to the medians and either roll over or are captured by the barrier.

Bounce-over crashes occur most commonly on medians steeper than 8:1; most bounce-over crashes occurred on medians between 6:1 and 4:1. Medians in this steepness range are often used to facilitate large rain runoff from the road; as a result, many medians have moist or wet soil through much of the year, even in drier climates. The softer median terrain does not facilitate bounce-over for larger vehicles since a large amount of soil is typically displaced after engaging the slope, which dissipates much of the energy contributed to “bouncing”. Smaller vehicles, which frequently have much lower pitch and yaw inertias, bounce due to the impact without displacing much soil. This is why only small to mid-size cars were engaged in bounce-over impacts in this crash database.

6.3.4 Override Penetrations

Simply defined, override penetrations were those in which the vehicle drove over the top of all of the cables before passing to the non-impact side of the cable median barrier. Note that “bounce-over” crashes, in which the impacting vehicle rebounded off of the median slope and passed over the barrier, were segregated from override penetrations due to median slope contributions.

Override crashes could occur due to vehicle profile, vehicle orientation angle at impact, cable entrapment in or on a post, ramp formation, or excessive cable sag. Of these possibilities, cable entrapment, ramp formation, and vehicle orientation at impact were the most common causes. Virtually every large ½-ton or ¾-ton pickup truck class has a rear end bumper height which is approximately 3 to 5 in. (76 to 127 mm) higher than in the front. Since many cable median barrier systems have a top cable mounting height less than 35 in. (889 mm), many rear-leading pickup and large SUV crashes resulted in penetration that likely would have been adequately captured if cable barrier systems were taller. Due to the frequency of penetration crashes by Dodge Ram pickups manufactured in the years between 2002 and 2010 on virtually every cable median barrier system, it is likely that these systems could be at risk of failing to meet crash performance requirements established in MASH.

6.3.5 Low CG Trajectory Angle Penetrations

A broad class of penetrations that spanned multiple penetration mechanisms consisted of low-CG trajectory angle crashes which resulted in penetration. Low-angle impacts leading to barrier penetration occurred on every barrier make. According to the results of NCHRP Report No. 665 [22], approximately 55% of all run-off-road crashes occurred with CG trajectory angles less than or equal to 15 degrees. Due to the difficulty in determining when a penetration crash

occurred, it is likely that the number of low-angle penetrations is underrepresented in the penetration crash database.

Low-CG trajectory angle penetration crashes had contributions from post impacts and cable entrapment on posts, high-susceptibility vehicle front-end profiles and bumper heights, and low energy available for stable crush to occur, in addition to barrier-specific mechanisms. As a result, both override and prying underride penetrations occurred.

The risk of severe crash result associated with this containment failure was dependent on multiple factors. If the low-CG trajectory angle crash resulted in penetration when the barrier was installed on the traffic-side shoulder or approach slope, the vehicle entered the median. Then, the vehicle either increased the CG trajectory angle due to the median slopes and driver reaction, or came to rest in the median. Crashes in which the vehicle came to rest were not severe in general, whereas moderately low-angle cross-median trajectories were frequently severe. When the barrier was installed near the center of the V-ditch, the vehicle always came to a stop in the median. While this generally resulted in a low-severity crash, underride of the Nucor system caused several severe injuries due to occupant compartment deformation from roof crush. Low-CG trajectory angle penetrations did not occur on systems located on the back side of median slopes, but did occur when the barrier was installed on the opposite-side shoulder. Penetrations on the barrier when it was located on the opposite side of the V-ditch frequently resulted in severe crash outcomes.

6.4 Approximate Equivalent Vehicle Profile

High-orientation angle crashes which resulted in penetrations were found to share many common features between all proprietary high-tension barriers. Narrow-profile vehicles or vehicles with smooth front ends alter the expected interaction between the vehicle's front end and the cable barrier during high-orientation angle crashes. As the orientation angle approached

either 90 or 270 degrees to the barrier system, differences arose as the vehicle engaged the cable barrier system with the entire front or back surface instead of a concentrated impact at a corner. Impacts occurring along vehicle corners could be approximately equivalently simulated as a wireframe object with corresponding roll, pitch, and yaw moments of inertia impacting the cable barrier. Front- or rear-leading impacts instead engaged the cable barrier with an entire surface, which had a contour corresponding to a cross-section of the vehicle at a given time. This concept is illustrated in Figure 44.

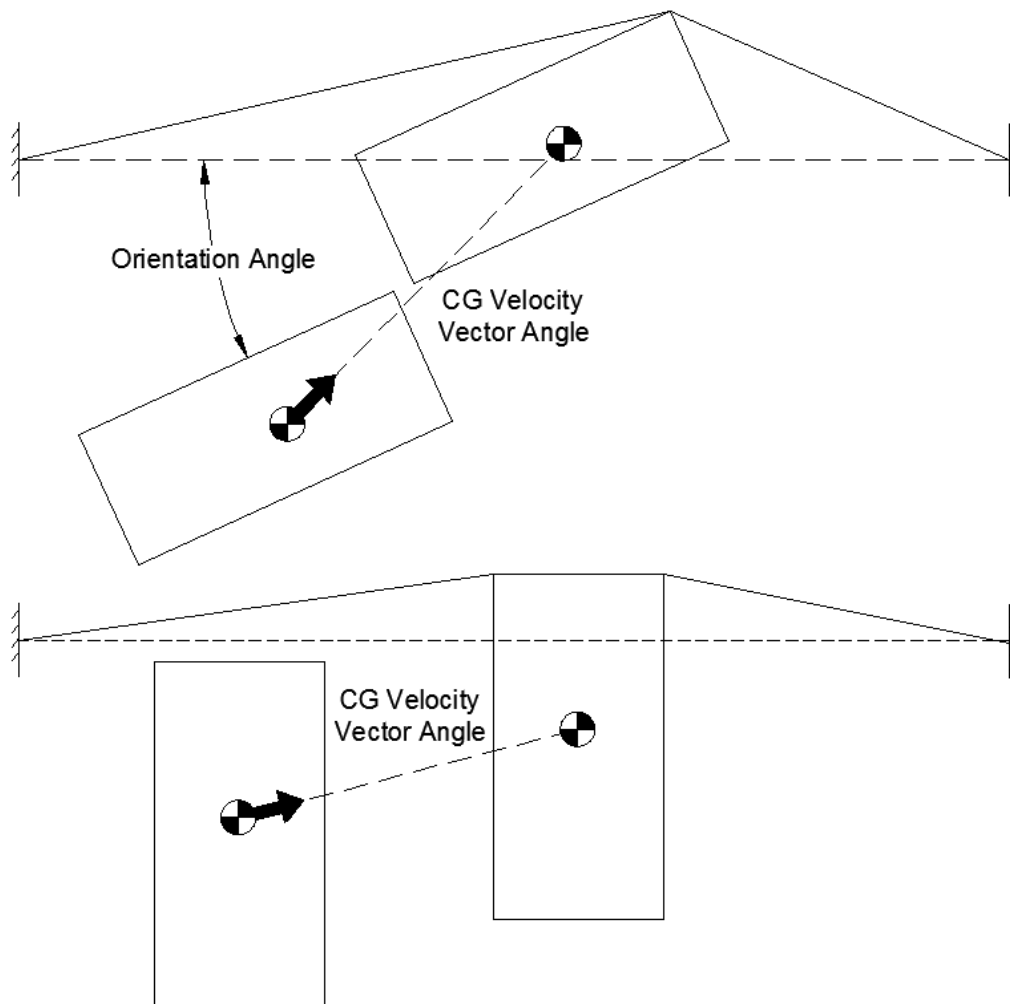

Figure 44. Approximate Equivalent Vehicle Profile Concept

The concept of an approximate equivalent vehicle profile may be conceptualized by considering a rectangular block striking a tensioned string. If the block strikes the strings with an

orientation angle other than 0, 90, 180, or 270 degrees, contact will be made along a leading edge, and the tensioned strings will trace the profile of the leading edge until contact is made with the trailing edge. Prying underide penetrations occurred when the leading edge caused cable separation or lifting. If the vehicle orientation at impact was 0, 90, 180, or 270 degrees, an entire surface contacted the cable. Rounded or smooth vehicle front-end surfaces caused separation or lift when impact occurred near the midspan. This susceptibility was amplified with aerodynamic, pointed vehicle front ends. Large vehicles were also sometimes able to push the cables down and override the barrier if bending waves propagating through the cables caused the cables to disengage from the front bumper.

The major difference associated with the performance in high orientation angle crashes was that with non-localized contact along the entire front of the vehicle's profile, the applied stress along the cable was decreased. Smaller distributed forces caused as much displacement as larger, concentrated forces, but the distributed forces did not surpass the elastic limit of the front-end components on the vehicle. Because elastic deformations are very small in comparison with cable barrier deflections, the vehicle effectively became a rigid body which could lift cables above the bumper and hood, separate the cables and allow the vehicle to penetrate through the barrier, or override the cables, depending on the shape of the vehicle's front end.

6.5 Cable Tension and Dynamic Deflection

As discussed in Chapter 4, there was an increased risk to occupants of errant vehicles in any high-tension cable median barrier crash that appeared to be associated with the higher tension in the cables. Although higher cable tensions do tend to reduce dynamic deflections, the effect was not as pronounced as many engineers have assumed previously. Dynamic deflections in tests conducted on cable barrier systems, including roadside systems, were plotted by impact severity. Impact severities were derived from crash test results submitted to FHWA for eligibility

status for use on the NHS, as well as testing agency reports. Results were included through 2010 and are shown in Figure 45.

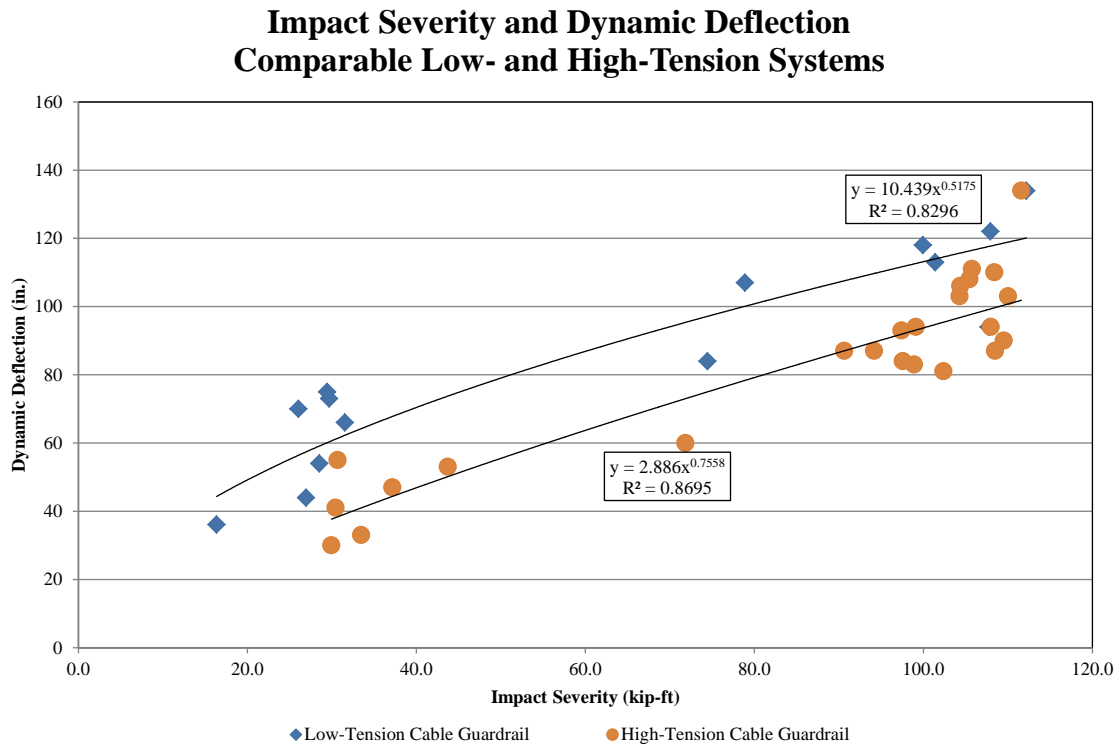

Figure 45. Dynamic Deflection Comparison, Low- and High-Tension Cable Barriers

As shown in Figure 45, at low IS-values below 40 kip-ft (54 kJ), high-tension barriers exhibit up to a 33% reduction in dynamic deflection compared to low-tension cable barriers. However, the difference in dynamic deflection between low- and high-tension cable barrier systems was approximately 15% with an IS value of 102 kip-ft (138 kJ). This IS value is typical of the standard impact condition for TL-3 impacts using a 2000P test vehicle according to NCHRP Report 350. Reported rates of dynamic deflections were always higher than the 15% average determined from full-scale crash testing. It should be noted that the high-IS value crashes with high-tension cable median barriers very closely correspond to, and occasionally intersect, data from low-tension crashes; the primary “benefit” of high-tension dynamic deflection reduction occurs at low IS-value crashes. However, the low-IS value crashes would

likely experience a greater reduction severity if higher dynamic deflections and lower accelerations occurred. This may contribute to the lower severe injury rate in low-tension cable median barriers crashes than occurred with higher-tension cable median barrier crashes.

Reasons that higher cable tensions do not produce a substantially lower dynamic deflection at high IS values include the following: (1) most high-tension cable barrier systems used weak, proprietary posts which were not as strong in strong-axis bending as S3x5.7 (S76x8.5) posts used in low-tension cable barrier systems; (2) higher tension on the cables produced a lateral redirective force with an approximate correlation to the sine of the angle formed between the deflected cable and adjacent supports, meaning weaker adjacent posts could not sustain as much load as the stronger posts used in low-tension 3-cable median barrier systems could and the cable deflection angle between the adjacent posts was frequently less than in low-tension systems; and (3) higher-tension systems frequently redirected vehicles with fewer numbers of cables since the higher restorative forces in the cables tended to allow vehicles to override lower cables or slip under higher cables. While there was a tangible benefit to using higher-tension systems, the associated cost must also be weighed in accordance with that decision.

6.6 Energetic Capture Concept

The increased risk of penetration due to a high orientation angle had roots in classical physics and mechanics. The cable capture phenomenon was strongly related to energetic constraints during redirection. When vehicles engaged cable barrier systems with standard crash testing conditions, with both CG trajectory and orientation angles of 25 degrees, the front bumper corner absorbed the initial impact through headlight fracture and crushing of the front fender panels. As the fenders collapsed around the cables, local energetic minima were generated according to cable positions. Additional force and energy contributions to the cable were

required in order to disengage the cables from the cavities formed by the crushed fender and fractured headlight. Higher energy input to cause cable disengagement limited the frequency of penetrations occurring after the capture sequence was initiated.

When vehicles impacted cable barrier systems with orientation angles approaching 90 or 270 degrees with respect to the barrier system, energetic constraints were altered. Until the front fenders, headlight, or grill were crushed and energetically favorable crush zones were generated, the entire stiffnesses of the vehicle ends were engaged. If a sufficiently large local stress threshold was not exceeded to cause plastic deformation of the front or rear ends, the tensioned and deflected cables applied force to a vehicle end in unstable equilibrium and the vehicle interacted with the cable barrier as if it was a rigid body.

According to the principles of minimization of potential energy, the cables followed the energetic path which tended to minimize internal strain energy. If capture did not initially occur, this path frequently caused cables to rise above the hood and roof or shift below the vehicle, unless intermittent locations of energetic minima were created (i.e., crush zones, such as the windshield or crown of the hood). The large stiffness of most vehicle front and back planes could prevent localized contact stresses from exceeding the elastic limit of the impacting components and prevent the initial capture engagement in some crashes. Without sufficient plastic deformation necessary to create energetically favorable crush zones, cables were shed from the front or back of the vehicle.

Higher cable tensions further decreased cable response times and maximized sensitivity to transverse wave motions. High-tension cables closely follow classical wave propagation equations for tensioned strings since the bending contributions become negligible at high cable tensions. As a result, wave speeds were functionally dependent on cable tension. Bending waves caused cables to disengage from the impacting vehicle in some crashes. Higher CG trajectory

angle crashes were also susceptible to these types of prying underride or cable-slip override phenomena.

6.7 Overall Discussion and Recommendations

As stated previously, low-tension, 3-cable median barriers had the lowest average rate of severe crashes and severe outcomes of all of the barrier types. Researchers postulated that this result was actually the culmination of multiple effects.

First, low-tension cable median barriers are frequently historical systems. Most low-tension cable median barriers currently installed in the United States were installed before high-tension cable median barrier systems became prevalent. Working knowledge of the barriers and the difficulties associated with mowing and ditch erosion around the posts were also expressed in research reports and DOT experience as the prominence of high-tension cable median barriers increased. As a result, many state DOTs began to place high-tension cable median barriers adjacent to the travel lanes on the shoulders in the hope that the problems experienced by roadside maintenance crews could be mitigated. Additionally, barrier placement on shoulders frequently improved ease of repair by maintenance crews since the workers were able to park vehicles in the median and repair the system at a safe distance from adjacent traffic.

However, crash severity is strongly correlated with the associated IS value at impact. Although systems in median centers experienced a higher frequency of crashes with high CG trajectory angles, the speeds of the crashes were almost always lower than when barrier systems were located on the shoulders adjacent to the roadways. This fact was particularly evident when comparing crash results of states with widely-varying median configurations. In Utah, median barriers were commonly installed at 1 ft (0.3 m) or 8 ft (2.4 m) from the center of the V-ditch, per Utah installation standards. Utah's large separation distance between the cable barrier and the travel way contributed to the lowest rates of A+K crashes compared to other aggregate severities

of high-tension cable barrier installations in other states. Conversely, in both Wisconsin and Washington, similar systems were frequently installed on barrier shoulders since medians were steeper and narrower to accommodate increased drainage and narrower right-of-ways. In both of these states, the crash severity on the same barrier type was considerably higher than in Utah. These effects had never been previously documented, and all three states were acting in compliance with the state-of-the-art in cable barrier installation practices and recommendations made by transportation safety agencies.

An analysis of the median data in Ohio indicated that, although penetration propensity increased to more than 17% when barriers were located within 4 ft (1.2 m) of the center of the V-ditch, crash severities were lowest when barriers were placed near the center of the ditch verses on the traffic-side shoulder, opposite-side shoulder, approach slope, or back slope. In fact, penetration propensity was nearly twice as large when barriers were installed near the center of the ditch compared to anywhere else in the median. One exception was the traffic-side shoulder, which had a penetration rate nearly equal to the penetration rate of the barriers installed near the center of the median. Yet, the percentage of serious injury and fatal crashes for barriers in median centers was less than half as large as when the barrier was installed anywhere else in the ditch.

In addition, nearly all severe crashes near the center of the median were caused by penetrations, occasionally resulting in cross-median crashes or rollovers. If penetration crashes can be prevented when cable median barriers are placed in ditch centers, the potential to reduce severe crash risk is very high. The results of the Ohio evaluation are shown in Table 24.

A chi-squared test was conducted on the severe crash, penetration, and rollover data, and the results were significant at the 10% confidence level; given the size of the data set at 857

crashes, the results should be interpreted as very significant since the data set is small with respect to A+K crashes.

Table 24. Ohio Cable Median Barrier Location Severity and Crash Result

| Barrier Location | K+A | % Penetration | % Rollover |
|-------------------------|------------|----------------------|-------------------|
| Center | 1.6% | 17.0% | 3.8% |
| Traffic-Side | 2.8% | 8.7% | 4.3% |
| Opposite-Side | 8.3% | 10.0% | 5.1% |

Penetration and rollover crashes with high-tension systems increased the risk of serious injury or fatality to occupants of errant vehicles compared to low-tension systems. However, penetration and rollover crashes typically constituted less than 55% of all severe cable median barrier crashes. Based on this finding, if penetration and rollover crash risks could be completely mitigated, many other severe crashes would still occur.

The highest combined PSCC and RSCC occurred with low-tension, 3-cable median barriers. Penetration and rollover crashes were less frequent on higher-tension systems despite an increased net occupant risk. This result suggests that high-tension cable barrier systems actually placed occupants at greater additional risk than low-tension systems due to the increased cable tension. The greatest advantages to high-tension systems included the ease of maintenance, ease of installation and repair, and versatility of the systems. Many posts can be placed in ground sleeves for rapid replacement, and the posts are small and lightweight enabling easy transportation. Most attachments are small and quick to repair. High-tension systems also retained tension after impact, reducing cable sag and reducing the requirement for immediate repair, a concern often cited with low-tension cable median barrier systems.

Ultimately, cable median barrier penetrations were caused by varied factors and heavily dependent on barrier design. Therefore, changes in barrier design can lead to immediate

reductions in the risk of penetration, as well as the rates of severe injury or fatal crashes. Based on the results of this study and the types of containment failures identified, improved barrier designs may be drafted, tested, and implemented. This could lead to the reduction of hundreds or thousands of severe injuries and fatalities.

7 PENETRATION CRASH ANALYSIS

7.1 Nucor TL-3 System on Flange Channel Posts

The Nucor NU-CABLE system was installed in many of the surveyed states, although the greatest quantity was in the state of Ohio. The most predominant causes of penetrations on the Nucor system were override events and prying crashes in which the vehicle pried cables upward and lifted them over the hood and bumper. Several crashes in which the strong cable-to-post attachments contributed to penetration containment failure occurred at CG trajectory angles much lower than are designated for full-scale crash testing in NCHRP Report 350 or MASH.

7.1.1 Override Penetrations

A total of 22 override penetrations were identified on the database of Nucor penetration crashes. Of these override crashes, 16 were linked to the strong cable-to-post attachment, 4 were due to vehicle launching over the barrier due to installation on a slope, and 2 penetrations were due specifically to the weak post-to-ground interaction. Photographs of the crashes were used to document failure types when available.

An example of a crash in which the strong cable-to-post attachments contributed to vehicular penetration through the barrier is shown in Figures 46 and 47. In this crash, an impacting pickup lost control due to slick roadways and departed the roadway into the median. The CG trajectory angle was approximately 24 degrees, and the orientation angle of the vehicle at impact was approximately 110 degrees. The vehicle impacted the cables and began to redirect. The first few impacted posts were pulled out of the ground as the pickup was redirecting, and the strength of the cable-to-post attachments retained the posts on the cables. Due to the high orientation angle at impact, the cables did not locally crush the fender at the front of the vehicle. This crush typically fostered proper cable-vehicle interaction and was commonly associated with



Figure 46. Penetration Crash Caused by Strong Cable-to-Post Attachment



Figure 47. Crash Result Due to Strong Cable-to-Post Connection

acceptable barrier behavior. Posts downstream from impact bent backward as the pickup progressed into the system, lowering the cable heights. Eventually, the vehicle overrode the cables and struck the round wood posts on the back side of a W-beam guardrail system. Due to the high orientation angle of the truck, the posts acted as a tripping mechanism and the pickup rolled five quarter-turns.

Although the weak post strength and high vehicle orientation contributed to the penetration, the primary cause of the failure was the cable-to-post attachments which failed to release the cables. In preventing cable release, the posts were pulled out of the ground or fractured, which deposited the posts on the ground and lowered the cable heights in front of the bumper. This type of override penetration was therefore referred to as a “ramp formation” failure. If the cables had been released from the posts, the cables would have remained engaged with the front of the vehicle.

The incident slope at the POI was 10.4:1, which was generally considered “flat” median terrain. Construction of the system was within the recommended tolerance, and the vehicle bears a strong resemblance to the Dodge Ram pickup trucks frequently used in MASH crash testing programs. Other additional crashes occurred in which the strong cable-to-post attachments caused override, but photographic evidence from those crashes was sparse.

A second example of the strong cable-to-post connection consisted of a combination of several component failures which culminated in the override penetration. Vehicle no. 1 hydroplaned on the roadway and struck an adjacent vehicle. The second vehicle swerved to avoid Vehicle no. 1 but was unsuccessful. After colliding with Vehicle no. 1, Vehicle no. 2 skidded into the median and struck a cable barrier, coming to rest on the opposite side of the system. The impact CG trajectory and orientation angles of Vehicle no. 2 were in the range of 10 to 15 degrees and 20 to 30 degrees, respectively. Unfortunately, a lack of vehicle trajectory

photographs prevented more accurate photogrammetric techniques from being used to calculate the encroachment angles. The final vehicle orientation angle was approximately 205 degrees, relative to the vehicle's original travel direction. Crash photographs are shown in Figures 48 and 49.

The penetration event occurred due to a combination of the following three factors: (1) sequential impacts with posts in the system caused post fracture in the socketed foundations with virtually no plastic deformation of the post; (2) the cable-to-post attachments remained firmly attached to the cables, causing the fractured posts to accumulate in front of the vehicle, while downstream posts fractured and were displaced back with the impacting vehicle; and (3) a long, unsupported length of cable combined with the weight of displaced posts tended to pull the cable downward, causing separation of the bumper cover of the vehicle and marginalizing the "capture zone". In this reference, capture zone (CZ) refers to the front area of the vehicle between the upper bumper surface and the lower edge of the hood. This area frequently corresponds to a blunt surface concealing cavities in the vehicle made for headlights, the radiator, and the engine compartment. The CZ concept has frequently been invoked when discussing cable barrier placement in V-ditches and explaining both the failures and successes of certain cable barrier systems, though a formal characterization has never been given to this region of the vehicle.

The bumper cover separation occurred moments before the vehicle overrode the cable barrier system. The bumper cover was displaced downward, allowing the top cable to engage the expanding gap at the top corner of the bumper cover. The large frictional force generated by the accumulated posts in front of the vehicle pushed the cable downward, slowing the vehicle rapidly. The vehicle overrode the accumulated posts which abruptly stopped the posts from sliding along the cables, and rapidly pulled the cables downward. As the cables dropped, they tore the bumper cover from the vehicle. The vehicle then possibly overran the bumper cover. The



Figure 48. Override Penetration Crash Caused by Strong Cable-to-Post Attachment



Figure 49. Override Penetration Crash Vehicle Final Position and Removed Bumper Cover

large forces contributing to the bumper cover removal also caused the vehicle to yaw, and it came to rest with an orientation angle exceeding 180 degrees.

Although the removal of the bumper cover in cable median barrier crashes is relatively infrequent in full-scale crash tests and from real-world crash photographs, the bumper cover failure was not likely the primary cause of barrier penetration. Failure in this crash was likely caused by the accumulation of fractured posts in front of the vehicle, combined with displaced posts upstream and downstream from impact. Although the removal of the bumper cover did reduce the tendency of the cables to accumulate around the bumper area, sufficient area was present beneath the bumper cover to allow a satisfactory redirection, as shown in Figure 49. The bumper cover was removed during an excessive downward force from the cables, which suggests that regardless of the type, make, or model of the vehicle in this impact condition, the vehicle may have had an increased risk of penetration or rollover.

7.1.2 Prying Underride Penetrations

The high strength of the Nucor cable-to-post attachments relative to post strength prevented through-cable prying events from occurring on the TL-3 Nucor NU-CABLE, flanged U-channel post cable median barrier system. All prying penetrations were caused by vehicle underride. Every Nucor prying failure occurred with one of the following impact conditions: (1) a low CG trajectory angle and high orientation angle (typically a large oversteering angle) contributed to prying penetration at first contact with the system; (2) a low CG trajectory angle and low orientation angle caused prying failure during initial contact with the system; or (3) after a moderately-high CG trajectory angle impact, the vehicle redirected at a low angle and made secondary low-angle contact with the damaged system, which then pried cables up before penetrating through the barrier.

Vehicles involved in prying failures were either narrow-profile, sharp-nosed vehicles, such as the early 2000s-model Ford Taurus, or vehicles which had stiff, rounded back ends such as the Pontiac Grand Am and Grand Prix models. As a result, prying failures were sensitive to combinations of initial orientation angle and vehicle front-end or rear-end geometries.

Several examples of prying failures were discussed here in greater detail. In one prying-type crash, a 1999 Ford Taurus struck the Nucor 3-cable median barrier with CG trajectory and orientation angles of less than 10 degrees when the barrier was located at the edge of the shoulder. The vehicle remained in contact with the barrier for approximately 60 ft (18.3 m) before prying the cables above the hood and coming to rest in the median. No photographs were available for this crash.

In a second prying case, a 1994 Chevrolet Camaro impacted the Nucor system with a sideslip angle of approximately 90 degrees. The vehicle entered a broad-side skid in an overcorrecting condition, striking a TL-3 3-cable Nucor barrier system with 20 ft (6.1 m) post spacing. The CG trajectory angle at impact was approximately 32 degrees, and the heading angle was approximately 118 degrees. Photos of the impact are shown in Figures 50 and 51.

In this crash, the vehicle oversteered into the median to avoid contact with another vehicle on the road. The high orientation angle of the vehicle did not provide a good engagement of the cables, with the vehicle impacting its right-front corner, and the cables slipped over the bumper and leading hood corner. The pointed front end of the vehicle accentuated vertical prying. The gradual slope of the vehicle permitted the cables to slide up and over the hood and roof, crushing and tearing both the front and rear windshields.

The driver was able to regain control of the vehicle path briefly, but overcorrected in the median and slid to a stop with an orientation angle of approximately 245 degrees. The vehicle



Figure 50. Prying Penetration Crash on Nucor NU-CABLE Barrier

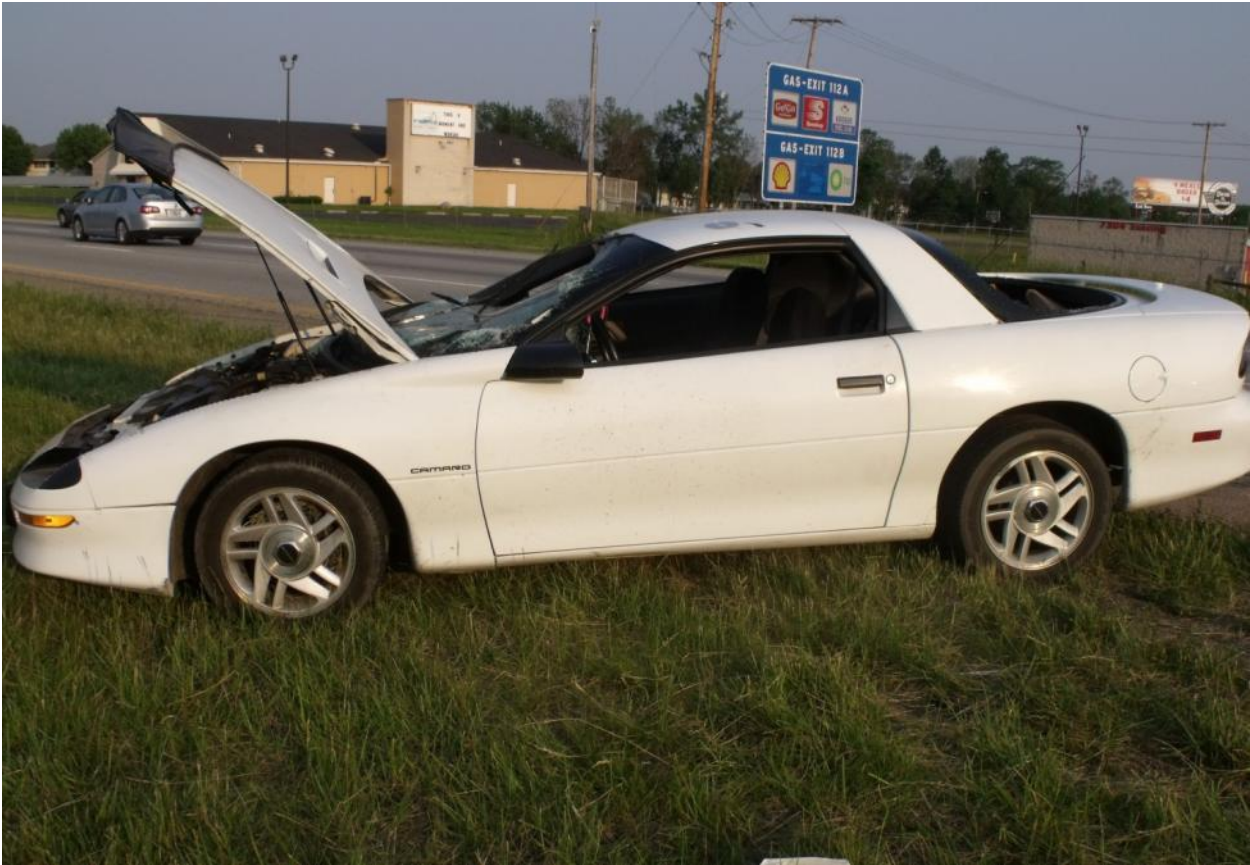

Figure 51. Prying Penetration Failure on Nucor NU-CABLE Barrier

engaged one post along the right side, and pushed the post downstream. The post remained attached to the cables after the vehicle passed underneath.

Partial penetration crashes, in which the propensity for complete penetration was demonstrated, were classified with other penetration crashes. Partial penetration crashes consisted of override penetrations in which two wheels of the impacting vehicle came to rest on both sides of the barrier or prying penetrations in which the vehicle came to rest beneath the cables.

One such potential penetration crash occurred with a 2003 Pontiac Grand Am, which struck the barrier with a low but unknown CG trajectory angle and an orientation angle greater than 100 degrees. The vehicle made an acceptable first contact with the barrier, as the lower cables crushed the right-front fender panel inward and fractured the headlight housing. However, due to the slope of the leading right-front corner of the vehicle and the strength of the cable-to-post attachments, the upper cable was forced up the vehicle's A-pillar, lifting the lower cables and tearing the hood supports. The hood was removed from the vehicle and came to rest at an unknown location in the median. The force required to remove the hood caused the vehicle to yaw around with the back leading. The second and third posts downstream from impact were struck by the rear of the vehicle and lifted out of the ground due to the prying action of the cables above the vehicle, but remained attached to the cables due to the strong cable-to-post attachments. The posts became wedged in the rear windshield, shattering the rear glass and crushing the roof inward. Photographs of the crash are shown in Figure 52.

Although the vehicle was brought to a stop in the median, the strong cable-to-post attachment could have seriously injured or killed an occupant in the back seat of the vehicle in this crash because of the retention of the post. Fortunately, no occupants were present in high-risk seat locations, and this crash resulted in only property damage. This crash result further



Figure 52. Potential Penetration Crash on Nucor NU-CABLE Barrier

served to illustrate that lower cable release loads and better post-soil and post-socket engagement is necessary to improve barrier performance. By improving these features of Nucor's barrier design, performance in prying situations would be expected to improve.

7.1.3 Diving Underride Penetrations

A total of 11 diving penetration crashes were identified in the Nucor penetration crash database. Of the 11 documentable diving penetration crashes on the Nucor barrier, 8 crashes occurred in medians with approach slopes steeper than 7:1 and when the barrier was installed close to the ditch center. In each crash, the CG trajectory angle was sufficient to cause suspension compression on the impacting corner, and the vehicle orientation angle was between 10 and 80 degrees to the barrier. No rear-leading or over-correcting diving crashes were documented, leading researchers to conclude that failures due to vehicular diving were sensitive to the impacting orientation angle.

One such diving crash that resulted in a penetration involved a 2009 Ford Fusion. Photographs of the crash are shown in Figure 53. A collision occurred between the Fusion and a second vehicle in an adjacent travel lane, causing the Fusion to veer off of the roadway into the median. The vehicle was oversteering as it entered the median, but due to the approximately 5.2:1 approach slope in the median leading up to the median barrier, the vehicle's front-end suspension compressed, and the vehicle dove beneath the lower cables, forcing the cables upward. Suspension rebound lifted the cables up, crushing and folding the hood toward the windshield before fracturing the windshield. Many posts upstream and downstream from impact were pulled out of the ground due to the underride collision, rendering the system inoperable for subsequent impacts.

A second example of a diving collision involved a 2003 Ford Taurus. Photographs from the impact are shown in Figure 54. The vehicle entered the median with an orientation angle



Figure 53. Diving Underride Penetration Crash on Nucor NU-CABLE Barrier



Figure 54. Diving Potential Underride Penetration Crash on Nucor NU-CABLE Barrier

greater than 60 degrees and a moderately-high CG trajectory angle of approximately 21 degrees. The vehicle had lost control due to snow and slush on the road.

The front suspension was compressed near the center of the V-ditch and began to rebound upward when the vehicle struck the cable barrier system, lifting the cables above the hood and onto the windshield. The suspension rebound caused the cables to engage and crush the A-pillars and windshield, which captured the vehicle. However, significant occupant compartment deformation occurred, and the vehicle demonstrated a clear propensity for penetration.

As an additional source of occupant risk in this crash, a post was lifted out of the ground due to the rebounding vertical force, and the post crushed and pierced the windshield. Post removal and subsequent interaction with the vehicle places occupants at higher risk of injury since occupant interaction with the displaced posts are a more direct source of injury than ancillary injury mechanisms such as a secondary collision in opposing travel lanes.

7.1.4 Nucor NU-CABLE Penetrations Discussion

The Nucor NU-CABLE barrier had the largest volume of photographs available. It also had the highest average severity for all of the high-tension barrier types. The penetration severity increase factor (PSIF) of the barrier was not very high, as shown in Table 21, which indicates that non-penetration crashes with the Nucor NU-CABLE barrier tend to be more severe on average than with other systems.

Strong cable-to-post attachments were disadvantageous in two ways: (1) the strong attachments tended to promote system override by forcing the cables to deflect downward with the posts on impact and (2) the inherently weak post-soil interaction and analogous low embedment of the post in socketed foundations increased susceptibility of post pullout from the ground or sockets. Although both conditions increased the serious injury or fatality risk to

impacting occupants by enabling penetration crash conditions to occur, the weak post-soil or post-socket interaction increased occupant risk more than override conditions because displaced posts which remain attached to the cables became spearing risks to small cars.

7.2 Trinity CASS Cable Barrier

Most of the Trinity CASS crashes in the available crash database occurred with the Trinity CASS system with C-section posts. Therefore, analysis efforts were focused on this system. However, penetration frequencies for all systems were virtually identical, and all mechanisms of vehicle penetration were present in each of the designs. Despite a large uncertainty associated with a relatively small dataset, the highest penetration crash frequency occurred with the TL-4 CASS system, which was susceptible to “through-cable” penetrations by mid-size to small cars. As a result, all of the non-through-cable penetrations of the three CASS systems were treated concurrently.

7.2.1 Ramp Formation Override Penetrations

A common penetration failure mechanism in the CASS system crashes was vehicular override of the barrier. From the 26 penetration override events with distinguishable causes on the CASS barriers, 23 of the penetration crashes were caused by the vehicle striking a post before contacting the cables. Because the cables in the CASS system were integrated into a slot in the top of the post, failure of the post to release the cables inevitably led to the formation of a ramp for the vehicle to climb and override the barrier system. Furthermore, evidence of this type of impact can be provided simply by examining the vehicles involved in override penetrations. Except for conditions of “bounce-over” in which the impacting vehicle rebounded off the median slope and penetrated over the top of the barrier, small to mid-size cars were rarely involved in override penetrations on any cable barrier system. However, small to mid-size cars comprised 31% of all override penetration failures on the CASS system.

Because post impacts contributed to cable entrapment in the slot and a reduction in system height, this type of failure was referred to as a “ramp formation” failure, with similar crash circumstances and outcomes as were observed with Nucor ramp formation override failures. Typical impact conditions contributing to ramp formation failures were low to moderate CG trajectory angles, typically less than 20 degrees relative to the roadway, and oversteering conditions in which vehicle orientation was a rotation toward the median. Overcorrecting and fully tracking crashes only constituted 3 ramp formation override crashes. Demonstrable crashes illustrating this failure mechanism could not be provided because reproduction of unauthorized scene diagrams or photographs would constitute a violation of non-disclosure agreements.

An additional override crash involved a vehicle towing a trailer. Most of the crashes involving a vehicle towing a trailer resulted in unfavorable cable barrier performance, by causing trailer “tip-over”, trailer penetration, vehicle rollover, or vehicle penetration. Frequently, these crashes were caused by oversteering gradients in the median. Trailers with high CG locations, higher bumper heights, flatter, stiffer body panels, and high rigidity, failed to engage cable barriers and increased penetration propensity. However, crashes involving passenger vehicles towing trailers were also infrequent. Thus, these crashes were not considered to be “failures” of the barrier, nor the fault of the DOT, construction or maintenance crews, or barrier designers.

7.2.2 Prying Underride Penetrations

A total of 26 prying underride crashes were recorded in the CASS penetration crash database with sufficient information to determine the cause of the penetration events. Of the 26 recorded vehicular prying penetrations, high orientation angle crashes accounted for 17 penetrations and low CG trajectory angle, low orientation angle crashes accounted for 9 penetrations. Low-angle crashes were treated separately because they displayed similar failure mechanisms as low-angle penetration crashes.

Most light to mid-size SUVs and some full-size cars were not typically involved in penetration crashes, since the broad front end combined with large bumper protrusions typically resulted in capture or rollover. One vehicle, which was involved in 21 cable median barrier crashes, but only one penetration crash, was a Dodge Stratus. The scene diagram from the penetration crash involving the 2002 Dodge Stratus is shown in Figure 55. Photographs of a 2002 Dodge Stratus, which was similar to the vehicle involved in the impact, are shown in Figure 56.

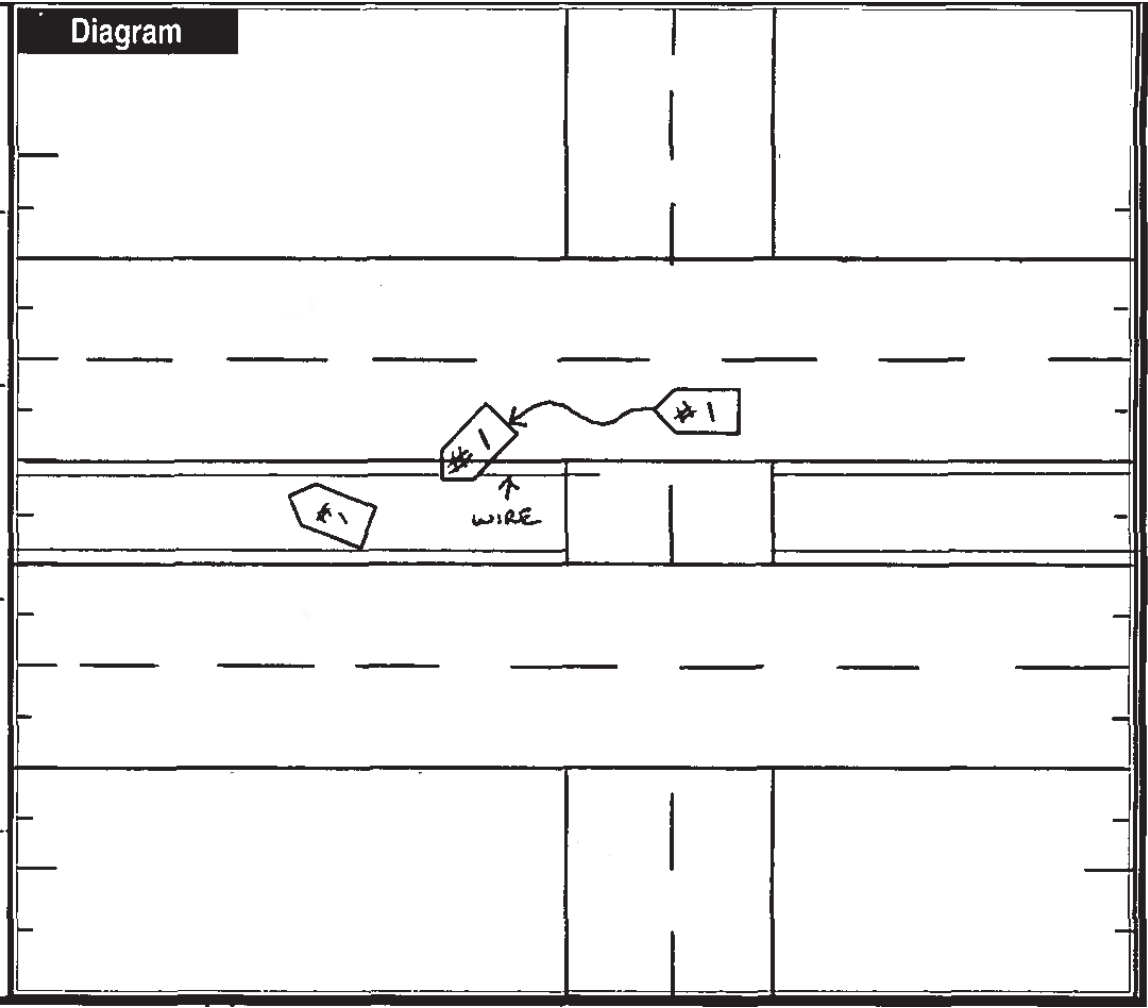

Figure 55. Scene Diagram of High-Orientation Angle Crash



Figure 56. 2002 Dodge Stratus Similar to Vehicle Involved in High-Orientation Angle Penetration Crash [33]

The Dodge Stratus was not typically involved in penetration crashes due to some unique features. The front of the vehicle was both broad and blunt, and the sides of the vehicle were relatively flat. Typical sill heights of the windows exceed 35 in. (890 mm), whereas the ground clearance averages approximately 16 in. (406 mm). Total vehicle height averages were approximately 55 in. (1,397 mm). This height provided a large surface over which vehicle capture was possible, and also required cables to rise substantially to pass over the top of the vehicle. Furthermore, depressions around headlights and taillights improved capture tendency.

Other high-orientation angle penetration crashes involving vehicles which were not traditionally susceptible to penetration were also observed in the database. These crashes supported the conclusion that high orientation angles increased propensity for penetration by altering the initial contact engagement sequence.

7.2.3 Low CG Trajectory Angle Penetrations

With respect to the CASS system, two override and nine prying underride penetrations resulted from low-angle impacts that were easily identifiable. Up to four additional cable barrier crashes may have also been low-angle penetrations.

The susceptibility of CASS systems to low-angle impacts was largely derived from how the cables interacted with the vehicle. Since the cables were initially engaged with the post in a center top slot in every CASS system type, low CG trajectory and low orientation angle impacts deformed posts downward in a mostly downstream direction or in the weak-axis direction post bending. However, the low angle of engagement also typically corresponded to lower levels of cable damage on the vehicle. The cables were not entrapped on the vehicle body and were free to oscillate or shift along the body panels.

In several crashes where a vehicle struck the barrier with moderate CG trajectory angles, as the vehicle began to redirect away from the first contact site, sequential impacts with downstream posts caused the vehicle's front end to yaw toward the barrier. The secondary impacts frequently occurred with low CG trajectory angles and higher orientation angles than were observed at the initial impact. Since posts upstream from the second impact were damaged, the secondary impact permitted greater rates of penetration.

Another frequent problem was observed during low-angle barrier impacts with narrow-profile vehicles or vehicles with smooth front ends. With vehicle protrusion under the bottom cable, the vehicle was able to pry upper cables out of the slot and away from the post. High cable

tension versus low cable tension frequently resulted in larger redirecting forces at similar angles of deflection. However, this was not always advantageous.

Higher vertical loading at the same deflection caused two problems. Vertical force was related to the angle formed between adjacent constraints. Cables displaced vertically sometimes caused longer sections of cable to be perturbed and lift out of the post slots once threshold vertical forces were exceeded. Downstream and upstream cable disengagement contributed to penetration propensity.

Alternatively, if the cables remained engaged with the slots and attachments downstream and upstream from the vehicle, the vertical load increased as the cable was lifted up over the hood. This resulted in large compressive forces on the suspension. As a result, the vehicle was pressed down and scraped against the ground or “bottomed out” on the springs, forcing the high-tension cables above the engine hood and potentially onto the windshield or roof. The vehicle could then either penetrate through the barrier or the cables could crush or cut into the occupant compartment. In either scenario, the risk of severe occupant injury was increased.

7.2.4 Diving Underride Penetrations

Only two diving underride penetrations were observed in the CASS database. Both occurred on the Trinity CASS system with C-channel posts and occurred in V-ditches with slopes between 4:1 and 6:1. Not all “diving” crashes resulted in penetrations or partial penetrations. Diving crashes typically resulted in higher severity on CASS systems than other cable median barrier systems due to the potential for roof crush by the bottom or middle cables. If the bottom cable remained adequately engaged with the vehicle and the upper cables disengaged from the slot, the upper cables occasionally crushed the occupant compartment.

The cable release load of the bottom cable in the CASS system was not available in published research studies. However, a brief mechanical analysis indicated that the weight of the

cable, the cable tension, and friction with the retainer clip likely could develop a net vertical release load per post of approximately 900 lb (4.0 kN). However, due to the vertical resistance of the upper two cables, the vertical release of the lower cable could rise by a factor of as much as 2.5, to approximately 2200 lb (9.8 kN). For posts deflecting during impact, the vertical release load can be even larger. During a diving or prying underride crash, the propensity for the lower cable to crush the hood or windshield could be very large if the low vertical release load of the bottom cable was increased.

Scene diagrams were not available for several non-rollover, non-cross-median, severe CASS crashes with passenger cars. It was believed that partial or complete underride was likely responsible for the severe outcomes. However, this estimate could not be proven with the currently-available dataset. Care should be taken to determine the cause of any serious crash involving the Trinity CASS barrier to ensure that the lower cables did not crush the occupant compartments of impacting vehicles.

7.2.5 Trinity CASS Penetrations Discussion

The TL-4 CASS system has very large cable spacing, which makes the system more susceptible to through-cable penetrations. If a vehicle protruded between the cables and lifted the upper cables above the hood, the bottom cable could remain tightly constrained and form either a trip point or pry point to permit larger rates of vehicle penetration through the system. Similar questions have been raised regarding the 3-cable Gibraltar TL-4 cable barrier since it, too, has a large cable spacing in excess of 8 in. (203 mm). Unfortunately, insufficient information was available in this database to evaluate and compare the safety performance of the TL-4 CASS and TL-4 Gibraltar systems with large cable spacings.

In general, placement of the cables in the post slot resulted in less desirable cable interaction with the vehicle. Although many crashes resulted in adequate containment with

relatively low damage to impacting vehicles, and dynamic deflections were relatively low in most crashes because good cable engagement occurred, many crash events resulted in undesirable results. By placing the cables within the center slot and constraining them, the cables are subject to the reaction of the posts and may not release properly, which increases penetration risk due to override and increased occupant risk due to underride. Barrier design improvements must be made to prevent these types of high-risk containment failures from occurring.

7.3 Brifen Wire Rope Safety Fence (WRSF)

The total number of Brifen cable barrier crashes exceeded 1,500, and cross-median crash rates of the Brifen system in Oklahoma were comparable with other systems used in the state. However, documentable cable barrier crashes, in which scene diagrams, photographs, and narratives were available, numbered approximately 120. Of this set, only 7 documentable cable barrier crashes resulted in penetrations. Thus, the penetrations were examined in great detail, but the relative frequency of each type of penetration event could not be determined.

7.3.1 Prying Underride Penetrations

Of the 7 penetration crashes available for further analysis, 5 were prying underride crashes in which the impacting vehicle struck and penetrated below the Brifen WRSF with little to no contribution from median slopes. The surprisingly high rate of prying penetrations, given the small data set, further illustrates the risk associated with low vertical release loads for the bottom cable. Vehicles diving under the barrier, or those which engaged the barrier such that the cables slipped over the bumper and were pried upward, experienced a significantly increased risk of penetration since the bottom cable could not resist the vertical uplifting and prying forces.

An example of a Brifen crash which resulted in a prying penetration is shown in Figure 57. With sufficient details to complete a full crash reconstruction, it was determined that the 2000 Toyota Avalon impacted the barrier at approximately 50.7 mph (81.6 km/h) with a 16



Figure 57. Prying Underride Failure on Brifen WRSF

degree CG trajectory angle and a 152 degree orientation angle, with respect to the barrier. The vehicle engaged the wire rope with the leading right-front corner, because of the high orientation angle.

Immediately after impact, the force of the redirection caused the vehicle to yaw with the right-rear corner turning into the barrier. These forces were eccentric to the vehicle's CG and thus were relatively low to cause yawing. As a result, the forces never exceeded the breaking strength of the front headlight glass casing and the cables did not crease into and engage the vehicle. As the vehicle's back end rotated into the barrier, the cables slipped over the front bumper and hood corner due to the prying force and the vehicle penetrated under the barrier. The sunroof was shattered due to contact with the cables.

The vehicle struck and bent four posts. One impact occurred at the front bumper, two occurred with the right-side body panels, and one occurred at the right-rear wheel, as shown in Figure 57. The vehicle occupants were not injured in this crash. Approach slopes leading up to the barrier were 9:1, and soil foundation tubes were in excellent condition.

Other prying penetration crashes were typical of this crash event. Vehicles impacted the barrier with large orientation angles, frequently with the right-side of the vehicle leading, and slipped under the wire ropes. These types of failures were predominantly due to the configuration of this barrier type. The lower cable on the TL-3 Brifen barrier was located at a height of 19½ in. (495 mm), but no vertical constraints were used to retain the bottom cable, due to the required weave in the lower and middle cables. Vertical release of the cables is largely resisted by gravity and friction with the post; however, this causes the dynamic release loads to be low.

7.3.1.1 Other Penetration Types

One override penetration and one diving penetration were recorded. The diving penetration crash occurred in an approved 6:1 V-ditch, in which the Brifen barrier was installed on the traffic-side approach slope. The vehicle exited the roadway at a relatively low angle, projected over the slope break point, then contacted the slope and began to rebound. During rebound, the vehicle partially redirected and yawed into and beneath the barrier.

The override penetration observed in the database was somewhat anomalous. In this crash, a heavy snowfall occurred prior to and during the crash. Control of the vehicle was lost, and the vehicle entered the median and struck the Brifen WRSF. However, the snow depth was so high that the barrier deflection was restricted, and the snow in front of the barrier contributed to ramping over the barrier. Such a penetration event is not expected in most impact conditions. Moreover, it would be difficult, if not impossible, to prevent such a penetration from occurring on other barrier systems. Due to the snow and low travel speeds, this crash has a low likelihood of a cross-median crash result.

7.3.1.2 Brifen WRSF Penetration Discussion

The Brifen penetration database was limited, but some clear tendencies were observed. First, due to the low vertical release load of the cable, the Brifen TL-3 WRSF was susceptible to underride from prying and diving failure types. Prying failures were the most common type of failure and the most common type of impact condition in general, especially when barriers were located at or near the shoulder. Thus, special care should be taken to improve the vertical release resistance of the lower cable and ensure adequate vertical resistance can be achieved. Though further analysis is necessary, it may be appropriate for barrier manufacturers to evaluate the effectiveness of installing vertical retainers on the lower cables that prevent the cables from *rising*, with lower vertical release forces to reduce trip propensity.

7.3.2 Low-Tension Non-Proprietary 3-Cable Median Barrier

Approximately 128 severe cable median barrier crashes in Missouri, 795 crashes in Washington, and 22 penetration crashes in North Carolina between 2001 and 2004 were examined in detail to determine causes of penetration or rollover occurrence on low-tension, 3-cable median barrier systems. Results of the analysis are provided below.

7.3.2.1 Override Penetration Crashes

Override penetration crashes on the low-tension, 3-cable median barrier were much less frequent than override penetration crashes on high-tension cable median barriers. Out of 71 cable median barrier crashes with determinable failure causation, only 8 crashes involved passenger vehicles overriding the barrier.

Out of the 8 override crashes, 5 involved vehicles striking the cable median barrier at large CG trajectory angles approaching 90 degrees. Although the override occurrence was usually associated with only larger passenger vehicles such as pickups, SUVs, and vans, a Hyundai Tiburon (Tuscani) was also involved in an override crash. The vehicle swerved off the road to the right, overcorrected, and redirected into the median at approximately 86 degrees before it vaulted off the slope break point of the 4:1 median approach slope and overrode the barrier. The cable barrier was installed on the traffic-side approach slope. The other four high-angle override crashes involved a large van and three pickup trucks. A sample scene diagram of a pickup high-angle override crash is shown in Figure 58.

The three other override penetration crashes were very low CG trajectory angle, low orientation angle crashes. In two crashes, the impacting vehicles were pickup trucks, and in the other, the vehicle was a passenger car. The vehicles impacted the barrier on relatively steep approach slopes, with the unmeasured slopes likely between 4:1 and 6:1 based on visual estimation. The vehicles impacted the cable median barrier, sequentially bending the S3x5.7 (S76x8.5) posts

downstream, then overrode the cables. The override was likely due to the following two factors: (1) the low tension in the cables was insufficient to prevent sagging when multiple support posts were removed from the system, and (2) the large vehicles with stiff exterior body panels were less conducive to energetically-favorable cable engagement. This engagement was frequently caused by crushing the vehicle exterior and retaining the cables against the sides of the vehicle. As a result, any sag in the cables lowered the height of the cables with respect to the impacting vehicle. As the vehicle bent the support posts, it was likely that the vehicles bounced or rode up the post, thereby further increasing the vehicle's CG height with respect to the cables, and potentially drove the cables downward beneath the wheels.

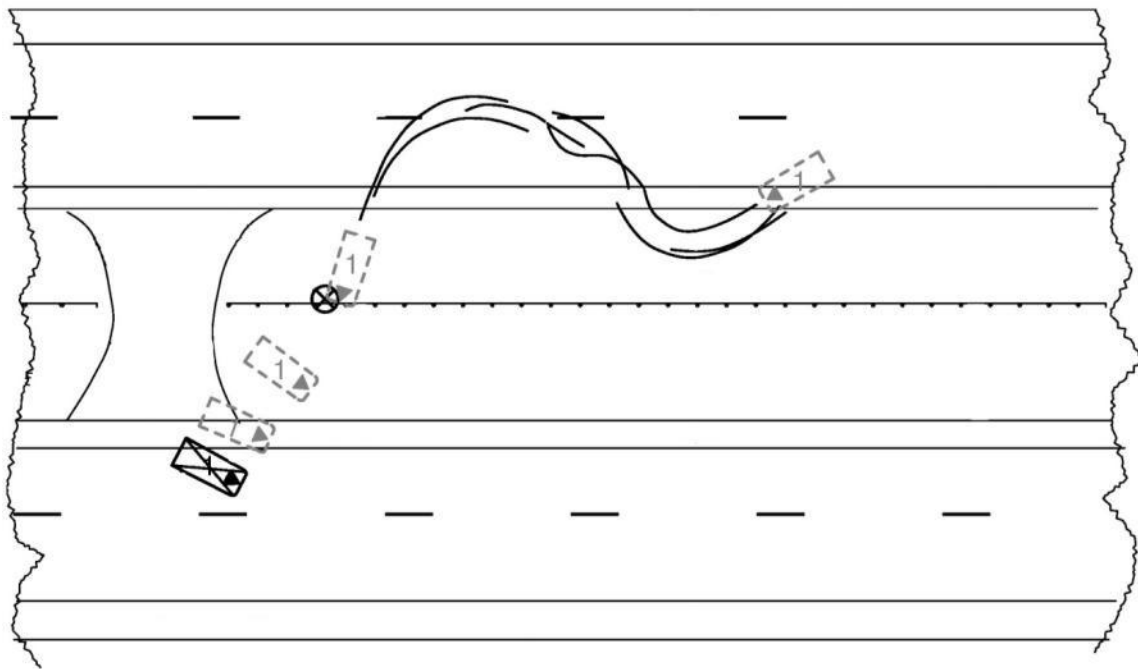

Figure 58. High-Angle Override Penetration Crash Example

7.3.2.2 Diving Underride Crashes

A far more common type of penetration crash mechanism on the low-tension cable median barrier was a diving underride crash. Many studies have been performed to improve the performance of low-tension cable median barrier performance in V-ditches [e.g. 25, 26, 38].

Underride failures with contribution from V-ditches steeper than 6:1 have often been cited as the most common failure of low-tension cable median barriers.

Of the 71 low-tension, 3-cable median barrier penetration crashes with determinable causes, 23 were due to diving penetrations. The low-tension, 3-cable median barrier utilized a $\frac{5}{16}$ -in. (8-mm) J-bolt. A study conducted at the Midwest Roadside Safety Facility (MwRSF) on the strength of the J-bolts, commonly referred to as hook bolts, determined that the peak horizontal pullout load of the $\frac{5}{16}$ -in. (8-mm) J-bolt was approximately 719 lb (3.20 kN), and the peak vertical pullout load was approximately 636 lb (2.83 kN) [39].

Most underride crashes occurred when the bottom cable was on the opposite side of the post relative to the impacting vehicle travel direction. Although not recorded, several estimates of frequency were made regarding back-side penetrations, and suggest that at least 60% of all underride penetrations occurred at locations where the lower cable was on the opposite side of the post relative, to the impacting vehicle.

The North Carolina penetration database supported this finding even though it was not a true “random sampling” of penetration crashes. However, causes of the penetrations and the associated crash circumstances in North Carolina were unknown to the researchers at the time of the crash investigations. It was observed that 15 of the 22 North Carolina penetration crashes, or approximately 68%, were back-side crashes. Of these, it was determined that 8 of the back-side crashes resulted in the vehicles diving under the cables.

Although median slope rates did have an effect on diving penetration rates, median slopes alone did not completely describe the risk of diving underride penetrations. Many of the sloped medians were shallower than 6:1. One diving penetration occurred on a median slope of approximately 10:1. In that crash, the vehicle was traveling at a high rate of speed, launched off

of the shallow approach slope and struck the median approximately 4 ft (1.2 m) in front of the barrier, then dove under the cables. Photographs from the crash site are shown in Figure 59.

In general, slopes steeper than 8:1 were most susceptible to cable median barrier diving penetrations. Diving penetrations occurred less frequently if the impacting vehicle made contact with the barrier on the approach slope. The critical location causing diving penetrations was approximately 3 to 6 ft (0.9 to 1.8 m) from the center of the V-ditch, based on analyses of ruts made in the soil in the crashes in North Carolina. This determination was supported by literature [26]

Although photographs were not available for crashes in the state of Missouri, and thus no rutting analyses were possible, median profiles were estimated based on site-specific analysis and limited photogrammetric reconstruction. In each Missouri diving underride crash, the median slope was steeper than or equal to 6:1, and the back-side slopes were also steeper than or equal to 6:1. In every diving underride crash in the database, back-side slopes were as steep as or steeper than the approach slopes into the median. This suggested that the approach slope steepness had a significant effect on the propensity to compress the suspension. However, the back side slopes had the strongest correlation with diving propensity when the cable barriers were located near the center of the ditch. Steep back-side slopes caused more frequent penetrations than steep front-side slopes, and no diving crashes were observed when the cable median barrier was installed on a shallower slope. However, this type of installation may be subject to penetration, rollover, or other types of failures.

Despite the effect of suspension compression on the propensity for vehicle penetration through the barrier, the weak lower cable-to-post attachments strongly increased penetration propensity. The attachments disengaged from the posts at low loads and allowed the cables to slip above or below the vehicle. It was believed that in every recorded diving cable median



Figure 59. Diving Underride Penetration Crash in North Carolina

barrier crash in this database, the diving tendency would be significantly reduced or eliminated if the bottom cable-to-post attachment strength was increased. This could have reduced diving penetrations by as much as 50%. Increasing the release load of the bottom cable would likely increase contact forces between the impacting vehicle and bottom cable, which could result in better engagement and formation of the familiar cable crease observed on vehicles involved in successful redirections. Additional examples of diving underride crashes are shown in Figures 60 and 61.

7.3.2.3 Prying Underride Penetrations

Unlike most high-tension cable median barrier systems, low-tension, 3-cable median barriers were the most susceptible to through-cable barrier penetration. This type of penetration was restricted to prying type, although median slope and vehicle geometry also contributed to the penetration in some crashes.

Since prying penetrations were necessarily restricted to crashes in which vehicle diving under the barrier was not the primary cause of the penetration, the median profiles of typical prying crashes varied dramatically from the diving penetration crashes. Out of the 22 penetration crashes in North Carolina, all penetrations occurring on the median approach slopes were prying penetrations, and 5 of the 15 crashes where the cable median barrier was installed on the back slope were prying penetration crashes. Additionally in Missouri, only 1 of the 18 prying crashes occurred on the median back slope, while 2 prying penetration crashes occurred when the barrier was impacted on the opposite-side shoulder. Conversely, 13 prying penetrations occurred on either the approach slope or ditch center, and an additional prying crash occurred when the barrier was installed on the adjacent shoulder of the divided roadway.



Figure 60. Additional Example of Diving Penetration Crash



Figure 61. Additional Example of Diving Penetration Crash

Frequently, at least two prying risk factors were present in prying penetration crashes. Prying penetrations occurred when cables were lifted or separated and failed to engage the vehicle. As with the high-tension cable median barrier systems, prying penetrations were sensitive to the impacting vehicle orientation angles. These angles were cross-plotted against all severe cable median barrier crashes in Missouri, as shown in Figure 62. No clear distinction could be made between the two crash distribution data sets. Oversteering impacts, in which the vehicle orientation angle was greater than the CG trajectory angle, were 5 times more common for prying penetration crashes.

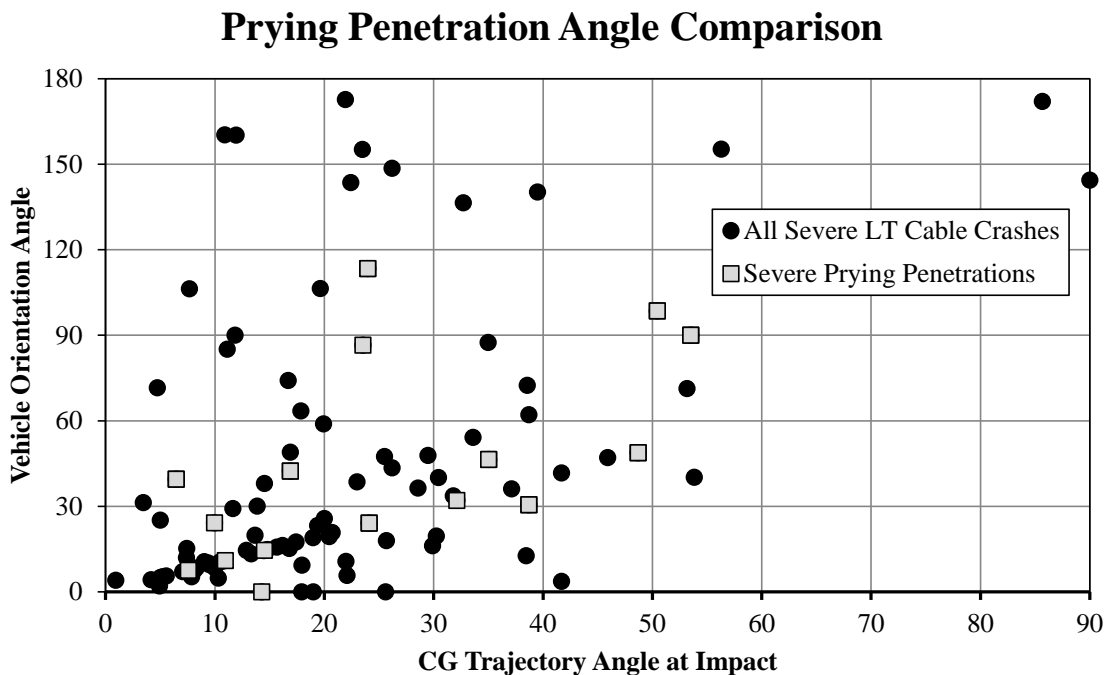

Figure 62. Comparison of Prying Penetration CG Trajectory and Orientation Angles

Prying penetration crashes typically occurred via a combination of the following factors:

- (1) cables located on the back side of the post released from many posts because lateral forces exceeded cable-to-post attachment strengths;
- (2) large orientation angles promoted bumper protrusion between or below the cables contributing to underride or through-cable penetration;
- and (3) low contact forces prevented beneficial body panel crushing or headlight fracture,

causing poor cable-vehicle engagement. Back-side cable release most commonly occurred when other cables failed to adequately engage the vehicle, so the entire redirection load was applied by one back side cable. Examples of penetration crashes in which the impacted back-side cable was removed from more than 10 posts downstream from impact are shown in Figures 63 and 64.

One anomalous penetration crash involved a Mitsubishi Montero equipped with a brush guard mounted on the front bumper. Crash photographs are shown in Figures 65 and 66. The vehicle struck the cable barrier system, and the angled surface of the brush guard forced two of the cables below the front bumper and one above the hood. The cable that was lifted onto the vehicle caused minor windshield damage and scratching on the vehicle's A-pillar. However, most of the vehicle damage was due to an unrelated rollover which occurred on the roadside of the opposite travel lanes long after the barrier penetration.

Such an event was anomalous because very few impacting vehicles were equipped with these guards. However, the effect of the brush guard in this crash was a microcosmic representation of the effect of weak cable-to-post attachments on strong posts. Even large passenger vehicles, which were typically excellent candidates for redirection on cable median barriers, were at an increased risk of prying penetration crashes at high orientation angles. This further supports the conclusion that orientation angles can alter the energetically preferential interaction of vehicles with cable median barriers. If a sufficient contact groove was not made before the impacted cables began to slip on the vehicle, the likelihood of redirection was very low.



Figure 63. Middle Cable Release from Many Downstream Posts Resulting in Penetration



Figure 64. Middle Cable Release from 11 Downstream Posts Resulting in Penetration



Figure 65. Prying Penetration Failure with SUV Caused by Brush Guard



Figure 66. Brush Guard Prying Penetration with Cable Contact Striations on A-Pillar

7.3.2.4 System Failures

Two cases of system failures were noted in the low-tension cable median barrier penetration database. In both crashes, the vehicle adequately engaged the tensioned cables and at least one cable formed a contact groove, fracturing the impacting corner headlight casing and collapsing the grill and fender around the cable. However, in both crashes, the low-tension cable splice failed, allowing the tensioned cable to rebound away from the vehicle. In one crash, the back-side bottom cable engaged the grill and headlight. As the cable was deflected with the vehicle, large tensions were developed in the cable and exceeded the strength of the cable splice. Similarly, in the other crash, the back-side middle cable engaged the bumper and grill of the impacting vehicle, crushing the fender and grill, characteristic of good capture behavior. As the cable was deflected with the vehicle into opposing travel lanes, high tension was developed in the cable and exceeded the splice limits. In both crashes, weak cable-to-post attachments contributed to splice failure. Photographs of the first crash are shown in Figures 67 and 68.

Since this crash result was only recorded on low-tension cable median barrier systems, better splices may be necessary for future low-tension cable barrier splices. A study of cable median barrier hardware identified several other splices which could be used or adapted for low-tension cable barrier use [40].

7.3.2.5 Other Penetration Causes

Other penetration causes were identified that led to penetrations on low-tension cable median barrier systems, including impacts with large vehicles (i.e., tractor trailers-or single-unit trucks), and bouncing override penetrations due to median slopes. However, as with the high-tension cable median barrier counterparts, bouncing override penetrations were impact condition dependent, and no cable barrier system manufactured had been tested and approved to redirect large vehicles (i.e. tractor-trailers).



Figure 67. High-Tension Splice Tearout Penetration



Figure 68. High-Tension Splice Tearout Penetration

Causes for bounce-over of low-tension systems were virtually identical to other systems. Since the arguments and outcomes were similar, the causes are not discussed here. Out of a recorded 70 cable median barrier penetrations on low-tension cable median barriers, only 2 resulted in a bounce-over. This could be the result of barrier placement, which was frequently near the center of the median or on the shoulder instead of up the median slope where vertical vehicle rebound was highest. Bounce-over penetrations may also be reduced by easy release of the top cable. Without sufficient additional crash information, the low frequency of bounce-over penetration crashes cannot be explained.

7.3.2.6 Discussion

Low-tension, 3-cable median barriers were the most susceptible barrier type to prying and diving underride penetrations on a fixed median terrain and with a fixed barrier placement, and the least susceptible to override penetration based on crash results obtained in this research effort. Strong cable-to-post attachments are essential for bottom and middle cables in low-tension cable median barrier systems. Reducing the vertical upward compliance of the lower cable could reduce the number of diving penetrations. However, care must be taken to prevent excessive stiffening of the cable against downward vertical motion on the post, or the lower cable will become a trip point for rollovers.

The advantage of the weak top cable-to-post connection is that with a low vertical release load, underriding vehicles did not experience occupant compartment crushing due to the top cable, and overrides were very infrequent when the cables quickly released from the post but remained engaged with the vehicle. This stratification of cable-to-post attachment strengths has not been optimized by any cable median barrier system in use to date and could be necessary to further improve cable median barrier design.

There is no evidence yet that many (if any) penetration crashes were caused due to cables which drooped in one location due to a previous crash. This may be due to excellent DOT response of rapid barrier repair at crash sites, which prevented these conditions from occurring. However, crashes in which two or more vehicles struck the cable median barrier only resulted in penetration if one of the vehicles was either a tractor-trailer or was towing a trailer, based on the available database. In both of these crash types, the vehicles which struck the barrier were not within the designed performance limits of the barriers. Further, crashes in which multiple vehicles struck the cable median barrier only constituted approximately 3% of all crashes in the database. If such a correlation existed and penetration propensity was higher when vehicles struck near previous crash locations, insufficient data was present in the database to indicate this increase. Nonetheless, states with low-tension cable median barrier systems often mandate barrier maintenance and repair within 48 hours of the crash notification. Even when repairs happen up to a two weeks after a crash, the repair timeframe appears to be adequate to prevent penetration events caused by previous cable barrier crashes from occurring. Shorter repair windows may be required during winter months when icy road conditions increase crash frequency.

8 CAUSES OF CABLE MEDIAN BARRIER ROLLOVERS

8.1 Overview of Crash Data

Unlike cable median barrier penetrations, rollovers caused by cable median barriers have not been well-studied. Manufacturers have noted cable barrier rollovers, but findings from these studies have not generally been made public. Frequently when rollovers were observed during full-scale tests on cable median barriers, results were largely dismissed as specific to an impact configuration or design concept failure [e.g. 41, 42]. Nonetheless, rollovers are real concerns for impacts with cable median barriers. In most states, rollover crashes were more severe but occurred less often than penetrations. Rollovers typically occurred in 3% to 8% of all cable median barrier crashes.

Rollover events were particularly cumbersome to reconstruct since rollover crashes were subject to many more factors than were penetration crashes. An accurate determination for the causes of the rollover was extremely difficult to obtain as median profile and smoothness, vehicle roof stiffness, angle of roll eccentricity, vehicle weight, and trip speed all affect the path of a rolling vehicle and the predominant locations of vehicle damage. Further, many scene diagrams are the approximate representations of a crash site and are drawn by the responding officer. As such, these diagrams were frequently inexact. One trait of all rollover crashes on cable median barriers is that, at the time of the rollover, all vehicles were non-tracking. Vehicles involved in rollovers which initially contacted the barrier with tracking impact conditions all yawed to non-tracking conditions before tripping.

Despite the difficulty in gauging trip causation, common factors were identifiable through narrative, scene diagram, photographic, and median slope evidence. Common factors associated with rollovers enable researchers and manufacturers to recommend improvements addressing general classes of problems instead of addressing individual crashes. Rollover causes were

largely independent of which system was installed, although rollover frequencies varied between systems. This finding was reasonable as all systems rely on three basic components: support posts to maintain cables at desired heights; cable-to-post attachments to maintain cable heights and transmit lateral and vertical load from cables to posts; and multiple tensioned cables. Similar to the determination of the causes of penetrations, a detailed investigation and analysis was conducted to determine the causes of rollovers on cable median barriers. A summary table of rollover causes is shown in Table 25.

Table 25. Causes of Rollovers with Cable Median Barriers

| Rollover Contributor | Description | Number of Rollovers Recorded | | | | | Total | Passenger Cars |
|----------------------|--|------------------------------|-----------|----------|-----------|-----------|------------|----------------|
| | | Nucor | CASS | Brifen | Gibraltar | Generic | | |
| Steep Median Slopes | Vehicle either impacts barrier installed on roadside shoulder and protrudes over median slope before a tire becomes snagged on the approach slope, or trips due to changes in the median terrain when barrier is located within ditch. | 3 | 6 | - | - | 7 | 16 | 13% |
| Broadside Skid | Vehicle contacts barrier with large oversteering orientation angle. Frequently, sideslip angles in these crashes are approximately 90 degrees. | 8 | 20 | 2 | - | 7 | 37 | 37% |
| Contact with Post | Vehicle struck cable median barrier and initially began to redirect. During redirection, vehicle tire snags on post or becomes entrapped by cable(s). Can occur when orientation angle approaches +/-90 degrees during redirection. | 12 | 24 | 1 | 1 | 19 | 57 | 42% |
| Other Effects | Rollover caused by other effects, such as end terminals, tow-behind trailer attachments, or large exit angles following redirection. Relatively infrequent events. | 1 | 2 | - | - | 2 | 5 | 25% |
| Large Vehicle | Tractor-trailers, buses, large trucks, camper vehicles, and construction vehicles. No cable barrier is currently designed for these types of impacts. Rollover crashes with these large vehicles are tolerated and better than penetrations. | 1 | 4 | - | - | 2 | 7 | - |
| Total | | 25 | 56 | 3 | 1 | 37 | 122 | 36% |

8.2 Rollover Analysis

8.2.1 Steep Median Slope Rollovers

When vehicles encountered steep median slopes (i.e., steeper than 6:1), rollover frequency increased, as was discussed in Chapter 4. These types of rollovers may be difficult to mitigate because the slope contributes to vehicle instability, thus new cable barrier designs alone

may not be sufficient to prevent these types of containment failures. The cable barriers frequently captured the impacting vehicle during these crashes, but the vehicle tripped and rolled before it was fully redirected.

There were three types of median slope-caused rollover failures. The first type was caused by entrapment, in which an impacting vehicle struck the barrier and the front (or rear) tires extended over the median slopes before the vehicle was redirected. Extension of the vehicle's wheels over the slope lowered the impacting end of the vehicle. Then, the subsequent redirective forces resisting the vehicle pressed the wheels of the impacting end against the roadside slope, potentially causing digging in on the slope or generating large frictional resistive forces as the suspension compressed. These compressive forces contributed to wheel entrapment on the median slopes and culminated in a frictional roll moment which caused rollover. This type of rollover almost exclusively occurred in impacts in which the CG trajectory angle was greater than 15 degrees and the vehicle encroached on the slope with orientation angles approaching either 90 or 270 degrees. An additional scene diagram of a rearward vehicle rollover crash occurring at a break point of a 6:1 approach slope is shown in Figure 69. The scene diagram was highlighted to indicate the locations of the median slopes.

The second slope-related rollover failure type was due to vehicle orientation near the center of a steep V-ditch. Vehicles were also captured during this type of rollover, but redirection frequently resulted in yaw displacement of the vehicle around the impacting end. Wheels on the other end of the vehicle were forced to climb the median approach slope which had been traversed during yaw rotation, which generated large, dynamic vertical and sideslip forces. Due to a combination of large trip forces, vehicle instability, digging in to the slope, post impact, or rough median terrain, the vehicle then tripped and rolled.

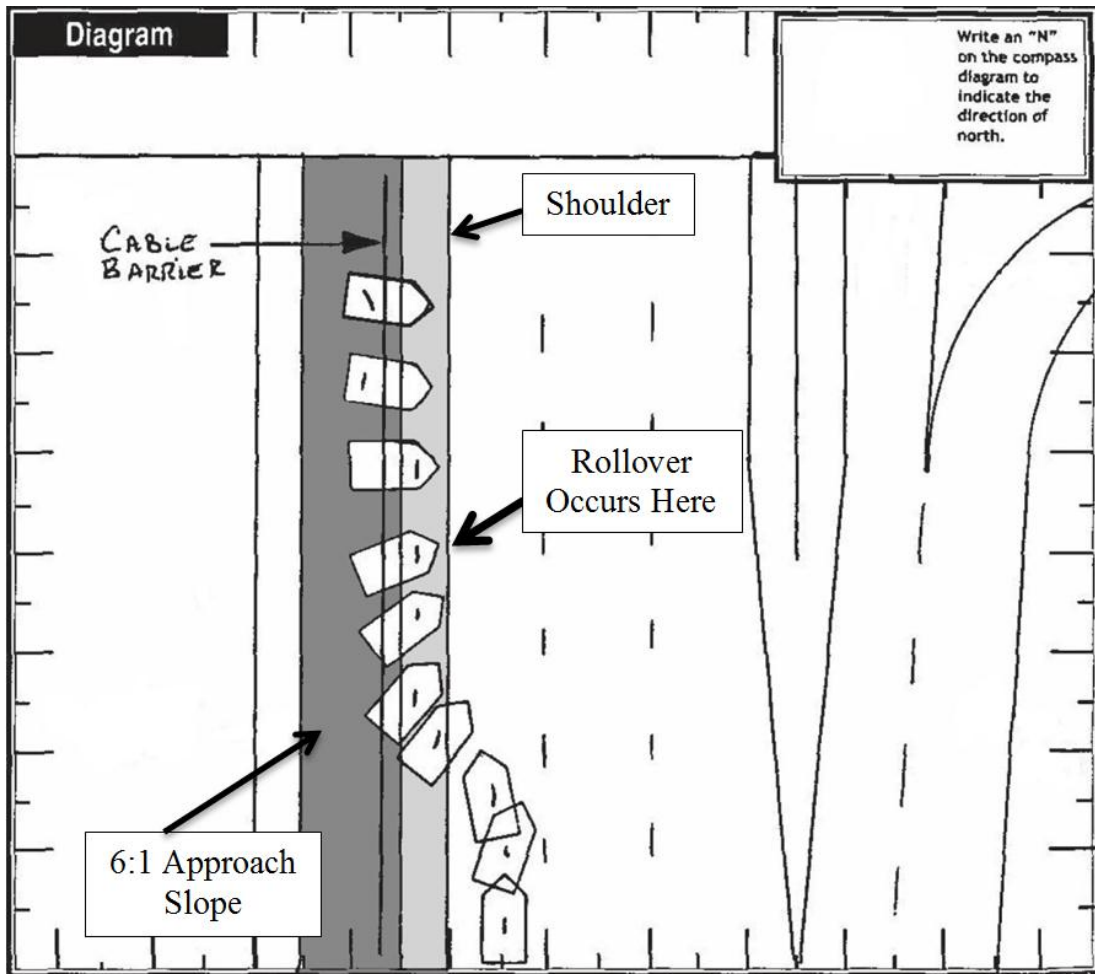

Figure 69. Entrapment Rollover Crash in which Vehicle Extends Over SBP of 6:1 Slope

The third type of median slope rollover was caused when vehicles struck a cable median barrier installed on a V-ditch back slope. After redirection, some vehicles skidded laterally into the median and tripped due to the slope transition in the center of the median. An example of this crash type is shown in Figures 70 and 71. In this crash, a Dodge Caliber struck the cable median barrier with an orientation angle of approximately 110 degrees and a CG trajectory angle of approximately 21 degrees. The vehicle displaced one post and yawed to nearly 180 degrees before being redirected, then rebounded down the back slope and tripped. It is believed that the vehicle made two and a half complete revolutions. Because the median rolled through the center of the V-ditch and back up the approach slope, vehicle damage was extensive.



Figure 70. Example Rollover Crash Caused by High Redirection on Back Slope



Figure 71. Example Rollover Crash Caused by Redirection on Back Slope (continued)

Pickup trucks, vans, and SUVs, in which the wheelbase and suspension stroke were large, were found to be the most susceptible to the median slope-related crashes. Passenger cars were involved in only 4 out of the 25 potential median slope-related rollovers. Of these, two were full-size cars, one was a mid-size “crossover” class vehicle, and one was a compact car. Also, it should be noted that a large oversteering angle was present in most of these crashes. A distinction was made between steep median slope rollovers and oversteering rollovers based on the largest contributing circumstance. Steep median slope rollovers were identified as crashes in which the vehicle “bounced” or compressed on the suspension due to the median slope, and the suspension compression and possible wheel entrapment on the slope were the largest contributors to rollover.

8.2.2 Broadside Skid Rollovers

Rollovers which occurred when vehicles struck cable median barriers with broadside skid conditions were much more common than steep median slope-related rollovers. Vehicles involved in these crashes either impacted the cable median barriers with sideslip angles very close to 90 degrees, or yawed to 90 degrees after impact before rolling over. Broadside skid rollovers were distinct from both contact-with-post and median slope rollovers because the cables were the primary contributor to rollover. Lateral redirective forces from the cables locally exceeded the stabilizing moment generated by the weight acting at the CG, tripping the vehicle. Passenger vehicles were involved in 35% of these types of rollovers, whereas SUVs, pickup trucks, and vans accounted for 65%. For those larger vehicles which rolled due to large oversteering angles, SUVs alone accounted for 29% of all rollover crashes.

Vehicle impacts at high orientation angles contributed to vehicle instability by increasing the overturning moment applied to the vehicle frame. A model and schematic diagram of the force interaction in a high-orientation angle crash is shown in Figure 72. During rollover crashes,

new, energetically-favorable roll axes were generated through which the applied moments to the vehicle were maximized. The new roll axis was rotated with respect to the longitudinal axis of the vehicle to incorporate the contribution of a small pitch moment at the cable impact location.

Because of this shift in the vehicle's trip axis, the back corner of the leading side of the vehicle was typically the first location to contact the ground. Frequently, first contact of the vehicle's upper body with the ground resulted in displacement of the upper frame rails, crushing near the rear-top corner of the vehicle, roof slant, and often an accumulation of dirt, grass, or median materials at the initial contact site. In addition to the increased pitch moment, vehicle-to-cable friction interaction caused yaw moments, which tended to increase the orientation angle. Thus, if the vehicle struck the barrier at a relative sideslip angle of 60 degrees, the frictional interaction with the barrier tended to accentuate vehicle yaw toward a 90 degree sideslip angle, increasing rollover propensity. Examples of broadside skid rollover crashes are shown in Figures 73 through 75. In each of the crashes shown, the vehicle struck the cable barrier with the front end at a high orientation angle then tripped and rolled. None of the crashes were caused by an impact with a single post or series of posts. Median slopes contributed to some crashes, but wheels were not entrapped on a slope in any of the crashes. Further, no trailer attachments or towed units were present.

One crash involving a Jeep Grand Cherokee is shown in Figure 73. During this crash, the vehicle struck the cable barrier with the left-front corner in an oversteering configuration, yawed around the front end, and tripped as the vehicle approached a 90-degree orientation angle. The right-rear corner made first contact with the ground, shattering the rear windshield and right-rear window. As the vehicle rolled, the roof was crushed, but most of the remaining damage to the vehicle only occurred to the exterior body panels. A similar crash involving a Suzuki Grand Vitara which also yawed around the front end before tripping is shown in Figure 74.

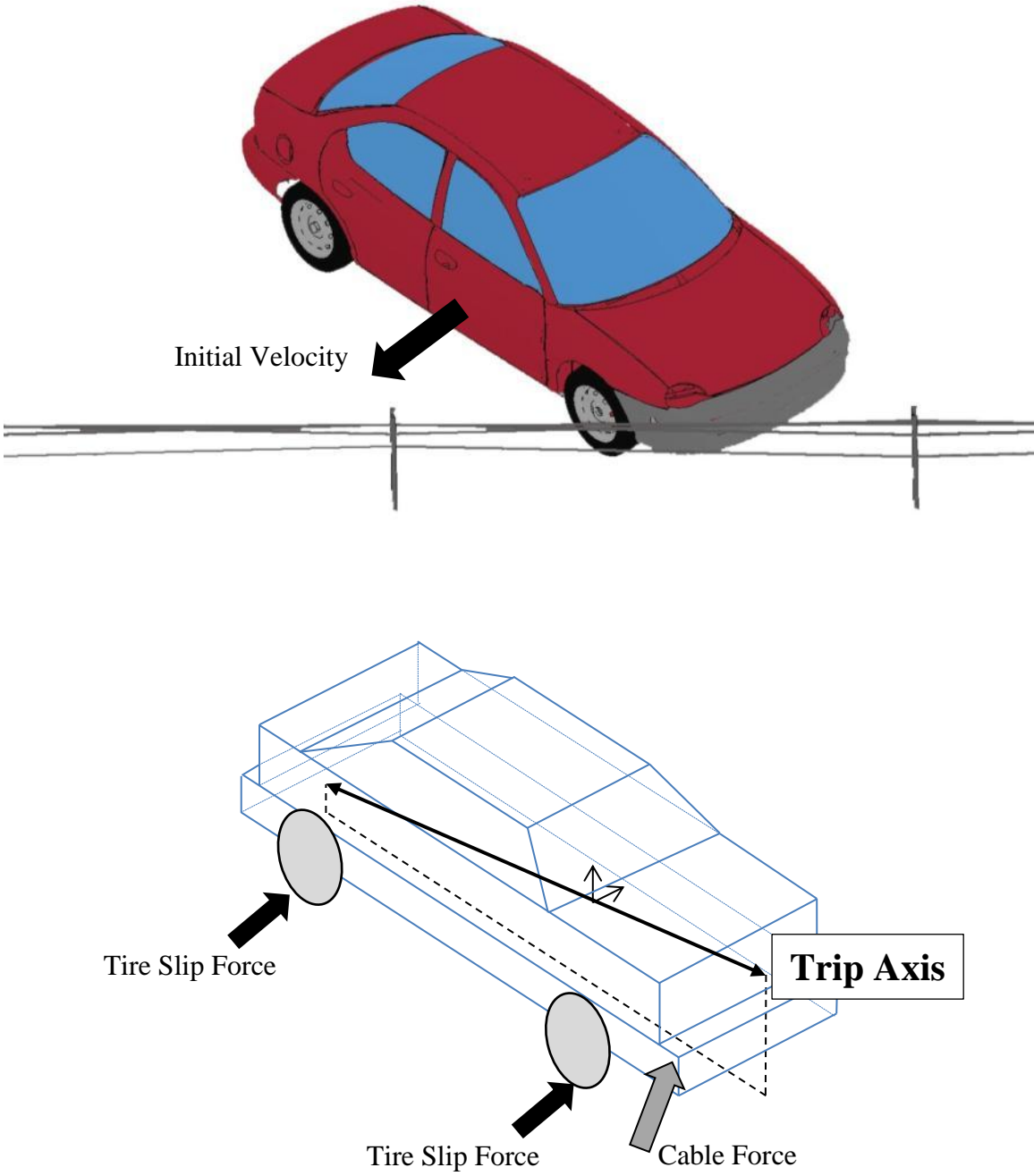

Figure 72. Impact at High Orientation Angle with Unbalanced Force Diagram



Figure 73. Example Rollover Crash Caused by High Orientation Angle at Impact



Figure 74. Example Rollover Crash Caused by High Orientation Angle at Impact



Figure 75. Example Rollover Crash Caused by High Orientation Angle at Impact

A second high-orientation angle rollover crash occurred involving an Isuzu Rodeo, as shown in Figure 75. During this crash, as the vehicle descended into the V-ditch, the right-front bumper corner engaged the cables. Combined with the large frictional moment from the tires, the vehicle tripped with the right-rear corner leading, and made one complete revolution, coming to rest on its tires. Most of the damage was concentrated on the right side.

8.2.3 Contact with Post Rollovers

The most obvious cause of rollover crashes was attributable to vehicles contacting and snagging on posts, which can form trip points. Unlike other types of rollover crashes, vehicle contact with posts can accentuate rollover risk for all impacting vehicles, including small cars. When comparing vehicle data within each barrier make, lighter vehicles were found to be more susceptible to tripping, as shown in Table 25. Mid-size and small passenger cars comprised 24 out of the 55 rollover crashes caused by post snagging, or 44% of all rollovers involving vehicle contact with posts. Furthermore, no large cars were documented with this type of crash result, and only 6 out of the 29 SUV, pickup truck, and van rollovers related to vehicle contact with posts had weights over 4,400 lb (1,996 kg).

Rollovers caused by contact with posts were unique because the rollover initiator was wheel snag on a flange or web of the post. Although multiple compounding factors including friction contributed to most rollovers, contact-with-post rollovers also occurred in wet and snowy weather when roadside friction was reduced. The occurrence of these types of rollovers in low-friction conditions indicates that even weak posts can contribute to vehicle instability, which was noted historically [43]. Examples of post snag rollover crashes are shown in Figures 76 and 77.

Contact-with-post rollovers were the most sensitive to the make of cable barrier struck, since post strengths were critical to facilitating rollover. Post shapes and cable tensions are shown in Tables 26 and 27, and several post section shapes are shown in Figure 78.



Figure 76. Example of Post Snag Rollover Crash



Figure 77. Example of Post Snag Rollover Crash

Table 26. Summary of Post Characteristics in High-Tension Cable Guardrail Systems

| Cable Barrier System | FHWA Approval Letter | Post Installation Option | Post Shape | Post Size | Post Material | Galvanization | Yield Stress ksi (MPa) | Maximum Post Shear Capacity kip (kN) | Critical Cross Section Area in. ² (mm ²) | Critical Moment of Inertia | | | Plastic Section Modulus | | | Strong Axis Bending Moment | Weak Axis Bending Moment | Rollover Rate |
|--|----------------------|--|------------|---|-------------------------------------|---------------|------------------------|--------------------------------------|---|---|---|---|--|--|--|----------------------------|---------------------------|--------------------------|
| | | | | | | | | | | Ixx in. ⁴ (mm ⁴) | Iyy in. ⁴ (mm ⁴) | Izz in. ⁴ (mm ⁴) | Sx in. ³ (mm ³) | Sy in. ³ (mm ³) | Sz in. ³ (mm ³) | | | |
| Nucor Steel Maroon Inc. NUL-CABLE | B-96 | (TL-3) Driven Post with Tripezooidal Soil Plate Socketed Post in Concrete Base | U | 6 kg/m (4 lb/ft) U-Channel with 3.8 in. (10 mm) hole | Nucor Steel Maroon Inc. Grade SP-80 | NA | 80 (552) | 51.6 (229) | 1.176 (717) | 0.606 (224800) | 1.125 (477500) | 0.496 (8121) | 0.656 (10742) | 0.519 (11782) | 0.779 (17160) | 39.6 kip-in. (4483 KN-mm) | 52.4 kip-in. (5930 KN-mm) | 3.2% (-5.6% TL-4 System) |
| | B-107 | | | | | | | | | | | | | | | | | |
| | B-183 | | | | | | | | | | | | | | | | | |
| | B-184 | | | | | | | | | | | | | | | | | |
| Tinky Highway Safety Products, Inc. CASS | B-184A | In Concrete Base-Plated Driven Sleeve with Notch Soil Plate | U | 7.5 kg/m (5 lb/ft) U-Channel with 3.8 in. (10 mm) hole | ASTM A 36 | NA | 80 (552) | 66.1 (293) | 1.423 (917) | 1.433 (596622) | 0.605 (9913) | 0.802 (13141) | 0.862 (14129) | 1.338 (21931) | 48.4 kip-in. (5472 KN-mm) | 64.2 kip-in. (7254 KN-mm) | N/A | |
| | B-195 Revised | | | | | | | | | | | | | | | | | |
| | B-119 | | | | | | | | | | | | | | | | | |
| | B-119A | | | | | | | | | | | | | | | | | |
| | B-119B | | | | | | | | | | | | | | | | | |
| | B-141 | | | | | | | | | | | | | | | | | |
| | B-141A | | | | | | | | | | | | | | | | | |
| | B-141B | | | | | | | | | | | | | | | | | |
| | B-141C | | | | | | | | | | | | | | | | | |
| | B-141D | | | | | | | | | | | | | | | | | |
| B-141E | | | | | | | | | | | | | | | | | | |
| B-157 | | | | | | | | | | | | | | | | | | |
| Hill & Smith Limited Batten Limited WRSF | B-82 | Driven Post in Concrete Footer | S/Z | 3.93 in. x 1.26 in. x 0.236 in. (100 mm x 32 mm x 6 mm) | ASTM A36 | A123 | 36 (250) | 29.0 (128) | 1.378 (888) | 2.629 (1094355) | 0.142 (59271) | 1.336 (21887) | 1.702 (27889) | 0.382 (6251) | 48.1 kip-in. (5472 KN-mm) | 81 kip-in. (926 KN-mm) | 3.2% | |
| | B-82B | | | | | | | | | | | | | | | | | |
| | B-82BI | | | | | | | | | | | | | | | | | |
| | B-82C | | | | | | | | | | | | | | | | | |
| | B-82CI | | | | | | | | | | | | | | | | | |
| Gibraltar Gibraltar Cable Barrier | B-137 | Driven Post Socketed Post-Rebar Tube in Concrete | C | 3.25 in. x 2.5 in. x 0.15 in. (83 mm x 63 mm x 3.4 mm) slotted tube | ASTM A570 (A1011) Gr 60 | ASTM F104-3A | 60 (410) | 53.8 (239) | 1.560 (1006) | 2.232 (929049) | 1.595 (663706) | 1.373 (22506) | 1.276 (20904) | 1.491 (24436) | 82.4 kip-in. (9227 KN-mm) | 76.5 kip-in. (8571 KN-mm) | N/A | |
| | B-137A | | | | | | | | | | | | | | | | | |
| | B-137B | | | | | | | | | | | | | | | | | |
| | B-137C (HSA) | | | | | | | | | | | | | | | | | |
| | B-137D (HSSD) | | | | | | | | | | | | | | | | | |
| | B-147A | | | | | | | | | | | | | | | | | |
| | B-88 | | | | | | | | | | | | | | | | | |
| | B-88A | | | | | | | | | | | | | | | | | |
| | B-88B | | | | | | | | | | | | | | | | | |
| | B-88C | | | | | | | | | | | | | | | | | |
| B-88D | | | | | | | | | | | | | | | | | | |
| B-88E | | | | | | | | | | | | | | | | | | |
| B-88F | | | | | | | | | | | | | | | | | | |
| Safence, Incorporated Safence Cable Barrier | B-64 | Plastic Sleeve in Concrete Footer Driven Post | C | 0.1575-in. (4-mm) thick C-post | Cold Rolled from A36 | A 123 | 80 (550) | 38.9 (172) | 0.840 (541) | 1.034 (430199) | 0.100 (41589) | 0.646 (10593) | 0.134 (2201) | 0.827 (13544) | 42.7 kip-in. (4863 KN-mm) | 6.6 kip-in. (749 KN-mm) | 4.9% | |
| | B-88F | | | | | | | | | | | | | | | | | |
| Low-Tension, 3-Cable Median Barrier | B-64 | Driven Post | S | S385.7 (S7688.5) 72-in. (1,829-mm) Long | A 36 Hot Rolled | Galvanized | 36 (250) | 35.1 (156) | 1.670 (1077) | 2.520 (1048903) | 0.455 (189385) | 1.680 (27530) | 0.391 (6400) | 1.940 (31790) | 60.5 kip-in. (6883 KN-mm) | 14.1 kip-in. (1600 KN-mm) | 7.8% | |
| | B-147 | | | | | | | | | | | | | | | | | |

Table 27. Standard Cable Heights and Tensions

| Cable Barrier System | Cable Heights | | | Cable Design Tension at 70°F (21°C) | |
|---|------------------------------------|----------|------|-------------------------------------|------|
| | System | (in.) | (mm) | lb | kN |
| Nucor Steel Marion Inc. NU-CABLE | TL-3 | 15* | 381* | 5600 | 24.9 |
| | | 21 1/2 | 546 | | |
| | | 25 1/2 | 648 | | |
| | | 29 1/2 | 749 | | |
| | TL-4 6:1 Slope or Flatter | 15 | 381 | | |
| | | 27 | 686 | | |
| | | 31 | 787 | | |
| | | 35 | 889 | | |
| | TL-4 4:1 Slope | 19 | 483 | | |
| 31 | | 787 | | | |
| 38 | | 965 | | | |
| 42 | | 1067 | | | |
| Trinity Highway Safety Products, Inc CASS | TL-3 | 20 13/16 | 529 | 4600 | 20.5 |
| | | 25 1/8 | 638 | | |
| | | 29 7/16 | 748 | | |
| | TL-4 | 20 7/8 | 530 | | |
| | | 29 1/2 | 749 | | |
| | | 38 1/8 | 968 | | |
| Hill & Smith Limited Briken Limited WRSF | TL-3 | 19 1/2 | 495 | 4250 | 18.9 |
| | | 26 | 660 | | |
| | | 26 | 660 | | |
| | TL-4 | 28 3/8 | 721 | | |
| | | 18 1/2 | 470 | | |
| | | 24 1/2 | 622 | | |
| 30 1/2 | | 775 | | | |
| | | 36 1/2 | 927 | | |
| Gibraltar Gibraltar Cable Barrier | TL-3 | 20 | 508 | 4800 | 21.4 |
| | | 25 | 635 | | |
| | | 30 | 762 | | |
| | TL-4 3-Cable | 20 | 508 | | |
| | | 30 | 762 | | |
| | | 39 | 991 | | |
| | TL-4 4-Cable | 20 | 508 | | |
| | | 25 | 635 | | |
| 30 | | 762 | | | |
| | | 39 | 991 | | |
| Safence, Incorporated Safence Cable Barrier | TL-3 Side-Mounted on O-posts | 18.9 | 480 | 3020 | 13.4 |
| | | 24.8 | 630 | | |
| | | 30.7 | 780 | | |
| | | 36.6 | 930 | | |
| | TL-4 I-post | 18.9 | 480 | | |
| | | 22 | 559 | | |
| | | 25.2 | 640 | | |
| | | 28.3 | 719 | | |
| | TL-4 C-post | 18.9 | 480 | | |
| | | 22* | 559* | | |
| | | 25.2 | 640 | | |
| | | 28.3 | 719 | | |
| TL-4 C-post MASH on 4:1 Slope | 19 5/16 | 491 | | | |
| | 30 15/16 | 786 | | | |
| | 34 11/16* | 881* | | | |
| | 38 7/16 | 976 | | | |
| Low-Tension, 3-Cable, Non-Proprietary | TL-3 | 20 13/16 | 529 | 950 | 4.2 |
| | | 25 1/8 | 638 | | |
| | | 29 7/16 | 748 | | |

*Optional cable shown

** 1st, 2nd, and 3rd cables are interwoven between posts

*** Posts are installed on alternating sides of system

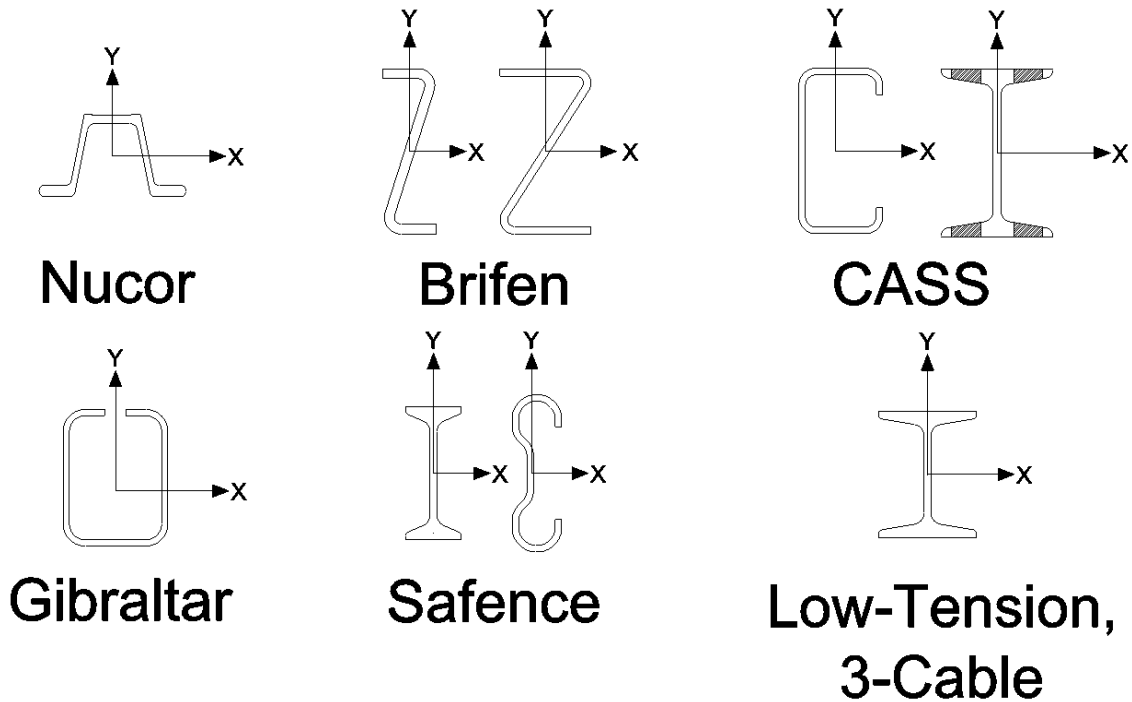

Figure 78. High-Tension Post Section Shapes

The cumulative rate of vehicle rollover on each system was plotted against calculated yield moments about the X and Y axes. Bending moments were calculated based on the assumption that no torsional warping occurred and that all loading occurred through each post section shear center. Scatter in the weak-axis bending moment direction appeared to be randomly distributed, as shown in Figure 79. However, a possible correlation was observed when rollover frequency was plotted against yield moments about the X direction, as shown in Figure 80.

Considering the large number of factors contributing to rollover events, these results suggested that there may be a strong relationship between post strength in bending along an axis parallel with the roadway and the frequency of rollover crashes. These results also indicate that post bending strengths along axes perpendicular to the roadway (i.e., the Y-axes) do not have a strong correlation with rollover frequency, as has often been assumed.

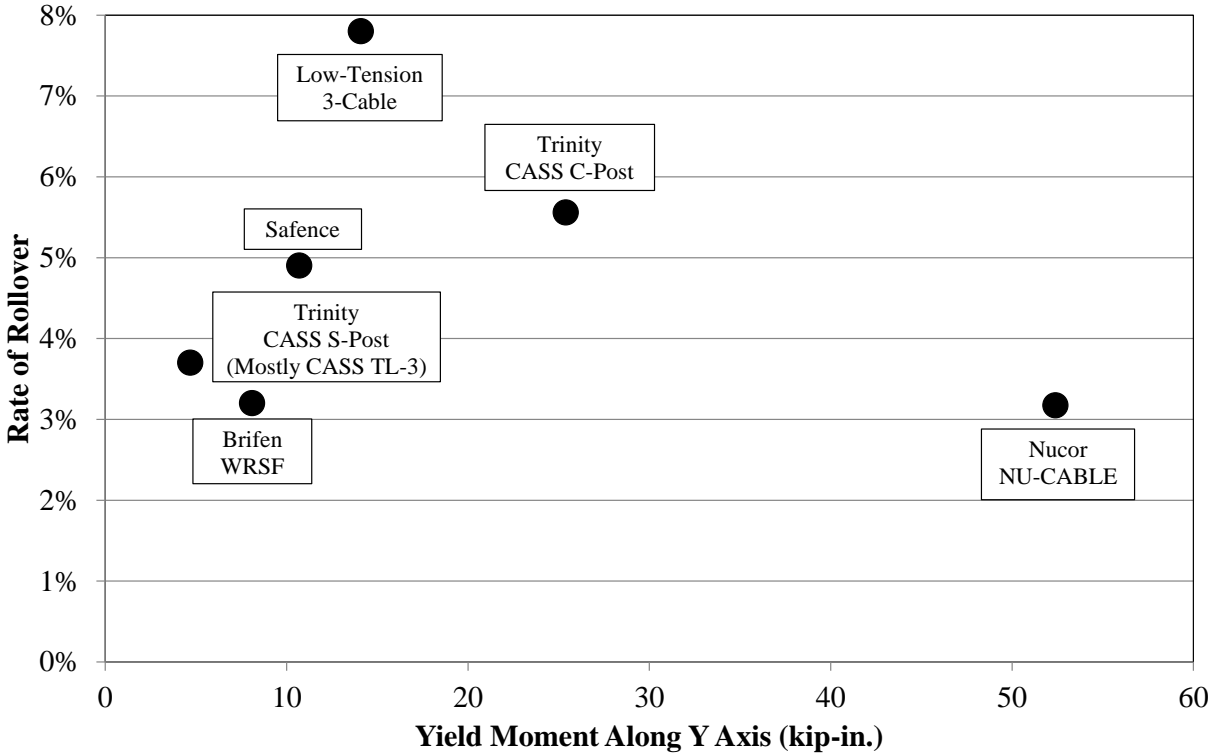

Figure 79. Y-Axis (Typ. Weak Axis) Yield Moment Relationship with Rollover Frequency

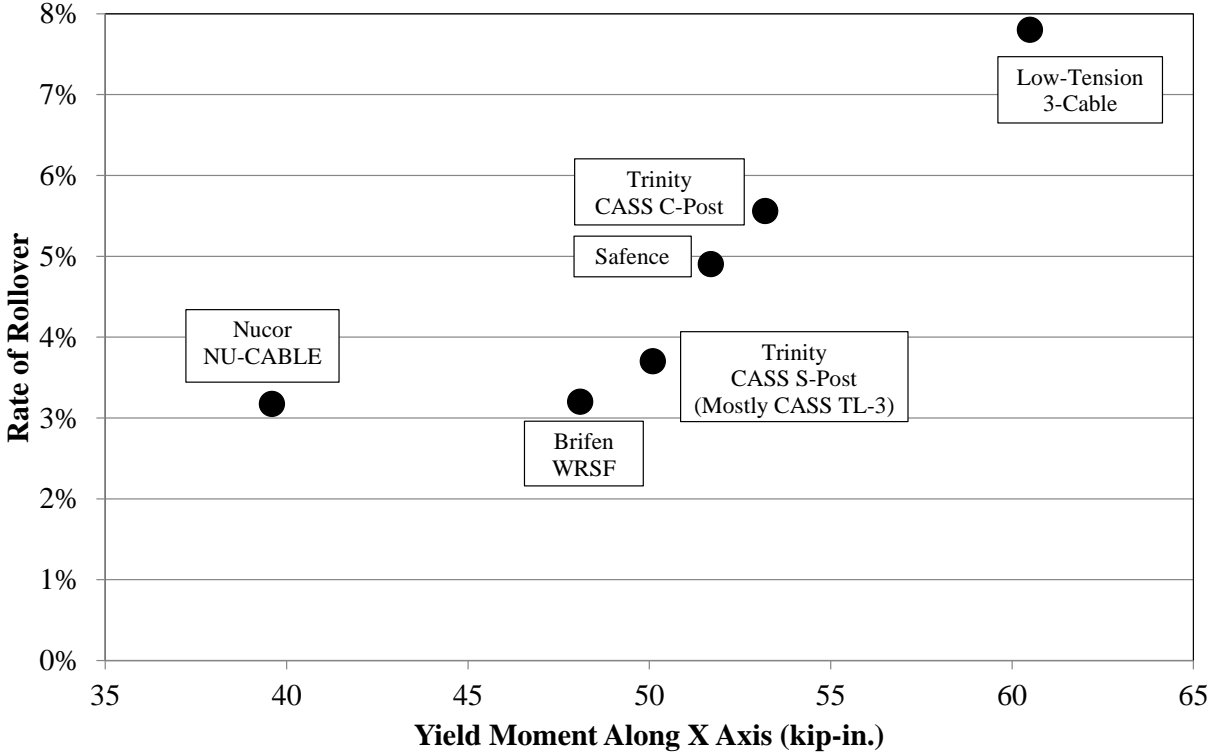

Figure 80. X-Axis (Typ. Strong Axis) Yield Moment Relationship with Rollover Frequency

Note also that many rollovers occurring due to impacts with Nucor systems were caused as posts accumulated in front of the vehicle after being lifted out of the ground or sockets, or fracturing at the ground line. As the posts accumulated, the effective strong-axis strength of the next downstream post increased. This effect, unique to Nucor systems, may have increased the average rate of rollover if the cable-to-post attachment was weaker and if the posts-soil interaction was stronger. If the Nucor result followed the trend of the other high-tension cable median barrier systems, the expected rollover rate would be between 1.9% and 2.7%.

8.2.4 Other Rollover Causes

Several other rollover causes were identified in the research study, although each cause was relatively unique. For these remaining rollover crashes, the most frequent rollovers involved large vehicles, such as tractor-trailers, buses, or single-unit trucks, as well as vehicles with tow-behind trailers. The increased rollover frequency for tow-behind units was likely the result of a high trailer center-of-gravity with respect to the towing vehicle. For example, the vertical CG height of many ½-ton to ¾-ton pickup trucks ranged between 25 and 30 in. (635 to 732 mm), but the storage floor height on most tow-behind units was at least the center axle height of the vehicle, typically 16 to 18 in. (406 to 457 mm). As a result, tow-behind trailers dramatically increased the effective CG height of the towing vehicle.

In particular, tow-behind camping units were particularly sensitive to rollovers. Over 60% of all vehicles with tow-behind campers were at least partially involved in a rollover event in the database, although trailer-related crashes were infrequent.

8.3 Discussion

In general, rollovers occurred less frequently than penetrations. However, this was not indicative of the difference in crash severities.

Rollover crashes increase risk of injury or fatality for the occupants of impacting vehicles. Occupants utilizing safety belts experience risk due to large accelerations, occupant compartment deformation or intrusion, or an appendage being pinned under the vehicle after flailing. Unbelted occupants are at higher risk of fatality due to bouncing and tumbling within the interior occupant compartment, as well as during ejection, in addition to the factors affecting belted occupants.

Rollover crashes were responsible for more A+K fatalities than penetration crashes. After a vehicle penetrates a cable median barrier and the barrier does not crush the occupant compartment or contribute to rollover, then the vehicle can come to a stop in the median without causing occupant injury. Penetration crashes resulted in property damage only (PDO) in 73% of the crashes, and on average, 7.9% of penetration crashes were severe. Using data only from states with complete data sets, rollover crashes resulted in only 35% PDO damage, compared to 17.3% A+K injuries. This indicates that, in the event of a rollover, severe crash outcomes are almost twice as likely as if the vehicle had penetrated through the barrier. Although prevention of cable median barrier penetrations is necessary to reducing the risk of severe crashes with cable median barriers, rollover crashes have higher associated severities in general and every effort should be made to mitigate these types of crashes.

High orientation angle crashes tended to promote a chaotic rollover path with combined roll and pitch motions. At high speeds, these types of rollovers were more severe on average than the other rollover types observed in this database. At lower speeds, more energy was transferred to the more energetic roll and pitch motions along the eccentric roll axis, as shown in Figure 72. These crashes had lower average severities than for other rollover types. As a result, little variation was observed between fatal and severe injury rollover crash frequencies, compared to

other rollover crash types. High-orientation angle crash fatality risk was 50% greater than median slope fatality risk and nearly 100% greater than the risk due to contact with posts.

One way to reduce rollover propensity is to place the cable median barrier near the center of the V-ditch, within 4 ft (1.2 m) of the centerline. Whereas penetrations occurred more frequently in ditch centers, particularly in narrow V-ditches, rollovers occurred approximately 20% less often in ditch centers than anywhere else in the median. Despite these competing factors, median centers were associated with the lowest rates of severe and fatal injuries. Moreover, penetration crashes are easier to prevent than rollover crashes in general, so factors which reduce rollover frequency may still have high benefit-to-cost ratios by reducing overall average crash severity even if the countermeasures increase penetration frequency.

A different method of reducing rollover frequency is to alter cable barrier post design. The frequency of rollover events with CASS C-post systems was nominally higher than other high-tension barrier systems at 5.6%, but rollover events on CASS systems with weakened S4x7.7 posts only resulted in a rollover rate of 3.7%, as shown in Table 26 and Figures 79 and 80. Strong-axis post strength appeared to be closely related to rollover propensity. Unfortunately, this presents a difficult design problem for engineers: strong posts, with high strong-axis bending strengths, had higher rollover frequencies than weak posts with low weak-axis bending strengths. However, strong posts were able to exert more lateral force on the vehicle during redirection, reducing the number of posts damaged in a crash and potentially reducing dynamic deflection. This results in a trade-off between rollover mitigation and design deflection.

Since the Gibraltar data set was extremely small, no statistics for the Gibraltar system were considered explicitly. However, Gibraltar utilized the strongest posts in bending about the X-axis. There is cause for concern that crashes with Gibraltar systems may be at elevated risk of rollover. Additional investigation with a broader accident database may be necessary.

9 DISCUSSION

9.1 Penetration Crashes

A maximum reduction in penetration crash frequency of 92% could be realized if all passenger vehicle penetrations were prevented. Practically, this is impossible, as penetration events can even occur on concrete median barriers, which are frequently cited as a replacement for cable median barriers involved in frequent penetrations. However, many of these penetration crashes can be prevented through improvements in barrier design, updated barrier placement guidelines, and by varying cable mounting heights on the posts.

There is a major advantage of high-tension cable median barrier systems over low-tension systems. Following most impacts on high-tension systems, the cables retain sufficient tension to minimize cable drop in the impact region where posts were disengaged from the cables. Crashes into low-tension cable median barriers frequently resulted in cable drop after impact. Some crashes involved two or more vehicles striking the low-tension cable median barrier in succession in Washington, Missouri, and in some non-penetration crashes in North Carolina. In many of these crashes, all errant vehicles were captured and redirected. However, state DOTs reported that crash sites were unsightly and suggested that any additional crashes at the same location could result in increased risk of penetration [23]. Higher-tension systems provided some sense of confidence that additional impact events would not result in penetrations.

The Gibraltar cable barrier system, with wide post spacings up to 30 ft (9.1 m) and installed on alternating sides of the cables, may exhibit a higher susceptibility to under-ride penetration crashes. Vehicles impacting at the location of a post on the opposite side of the cables can cause complete post disengagement. Although the hairpin cable-to-post attachment was relatively strong, as shown in Figure 81, upward vertical bracket release could occur during impacts with low-height, sharp-nosed and narrow front-profile vehicles, as shown in Figure 77.

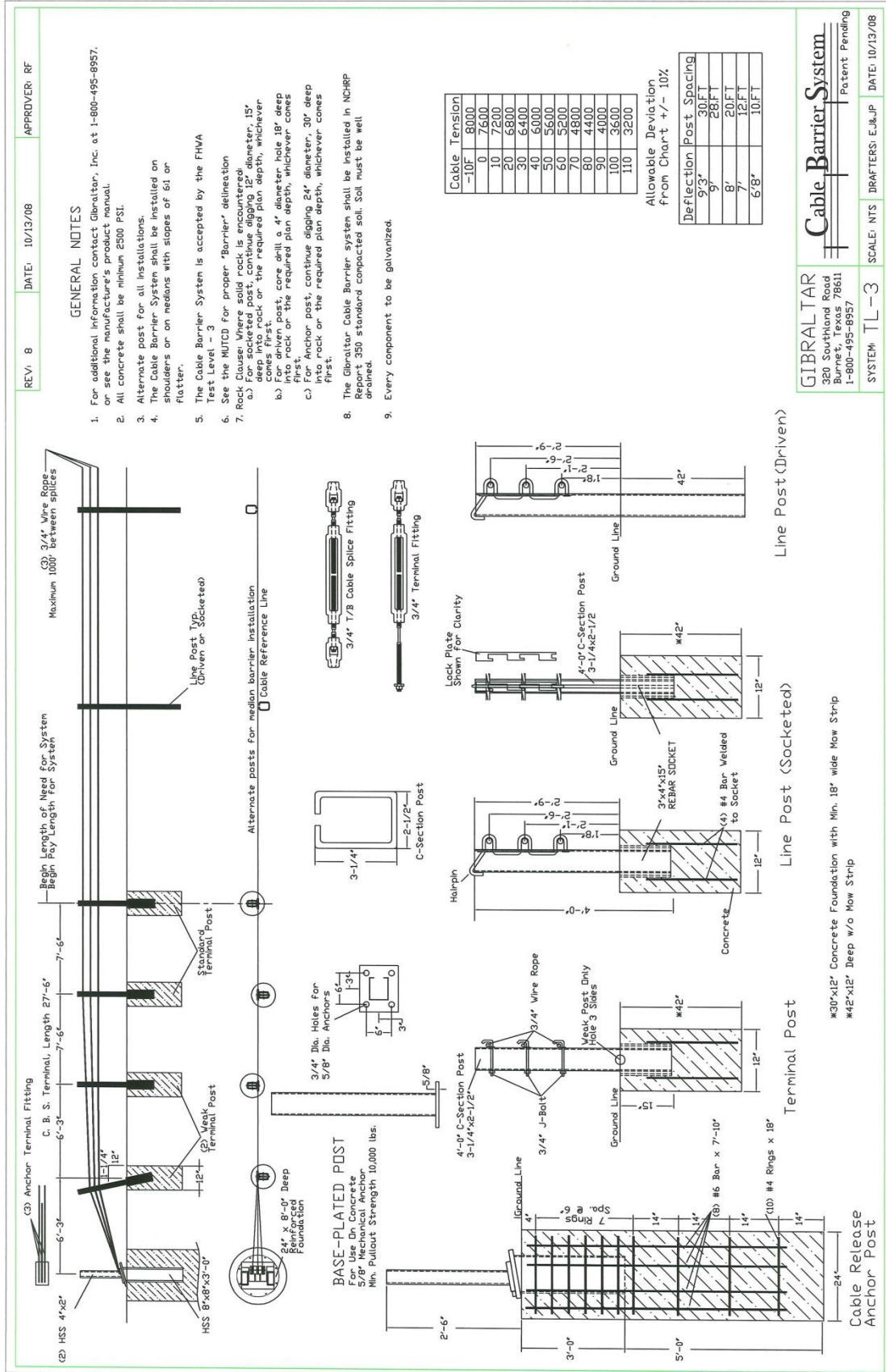

Figure 81. Gibraltar System Details, TL-3 System [44]

For posts installed at the approved 20- to 30-ft (6.1- to 9.1-m) spacing, any cable-to-post disengagement of a given post would result in a 40- to 60-ft (12.2- to 18.3-m) unsupported cable length upstream or downstream of the vehicle. With such large unsupported lengths, the barrier may experience an increased penetration frequency due to median slopes, low-profile vehicles, or vehicle crashes under non-tracking and high-orientation angle impact conditions.

Whereas the Gibraltar cable barrier system may be more prone to underride in some crash configurations, the vertical release load of the cable-to-post attachment may be sufficiently small to prevent override penetrations. Based on a preliminary analysis, the hairpin bracket should vertically release away from the posts when the posts deflect laterally, and impacts at the posts will less frequently cause the cables to be pulled down by the deflected posts. More analysis will be necessary to conclusively determine the accuracy of this estimate.

9.2 Rollover Crashes

Despite gaps in the available data sets, rollover crashes were likely more severe than penetration crashes on average since most penetration crashes involved vehicles coming to rest in the median with only property damage. Severe penetration events were limited to crashes in which the occupant compartment was deformed, barrier elements protruded into the compartment, or cross-median crashes occurred. Rollover crashes much less frequently resulted in property damage only. Low-speed, short-distance rollover events could also be severe if an occupant was ejected from the vehicle.

The cable entrapment within the vertical slots of the CASS barrier was found to contribute to penetration propensity when impacts at posts forced the cables to drop within the post slot. This effectively created a ramp to allow the impacting vehicle to pass over the top of the barrier, which also was associated with a high rollover frequency. However, the weakened S-

posts utilized in the CASS TL-3 and CASS TL-4 systems appeared to result in significant reductions in rollover propensity. Penetration frequency was unchanged for these posts.

The major difference in the performance of the CASS S4x7.7 (S102x11.5) posts was a significant reduction in strong-axis post strength. Since the weakened/modified posts were nominally more flexible at the ground line and yielded more quickly under the same impact conditions, vehicle capture occurred more frequently and more vehicles were brought to controlled stops. This proprietary design was reflective of the improvement that can be obtained by weakening a nominally strong post section in terms of its strong-axis bending capacity. Note that the Nucor flanged U-channel posts are not installed with the strong axis parallel with the roadway, and thus strong-axis weakening is not expected to have a significant effect on rollover propensity. Although this improvement would likely assist other cable median barrier systems, untested post modifications are not recommended for use in any barrier system.

9.3 Barrier Placement and Median Grading

As stated in Chapter 4, Section 4.2.4, barriers placed in medians wider than 40 ft (12 m) had optimal performance when installed near the center of 6:1 or 8:1 V-ditches. Penetration crashes were reduced from over 10% on slopes flatter than 10:1 or steeper than 5:1 to less than 8% on slopes ranging between 9:1 and 6:1. Likewise, rollover frequency decreased from over 5% for slopes flatter than 8:1 and steeper than 4:1 to approximately 1% on slopes ranging between 7:1 and 5:1. However, further analysis suggests that barriers placed in narrow medians may not experience the same safety benefits observed in wide medians. Current standards are under development to establish meaningful crash testing procedures for evaluating barriers installed within relatively narrow, sloped median ditches [20]. However, narrow, flat medians and barrier systems installed adjacent to wide shoulders are both expected to have nearly the same performance.

Many studies have been performed to determine optimum barrier placement within medians located between divided highways [e.g. 24-26]. From these studies, the optimum location for placing a cable median barrier is at or near the center of the V-ditch in order to prevent the maximum number of nuisance impacts. Unfortunately, this barrier placement poses problems for state DOTs in terms of erosion control and mowing concerns, as cited by most of the states surveyed in this study. Most states prohibited the installation of cable median barrier within 1 to 8 ft (0.3 to 2.4 m) of the center of the ditch, which was consistent with placement guidance provided by FHWA. Barriers located near the center of depressed medians can cause increased difficulty with the maintenance and repair work of damaged cable barriers. In addition, post socketed and end anchor foundations may require greater depths, diameters, and/or reinforcement as the ditch bottom generally has a higher moisture content than the adjacent median slopes.

In response to these concerns, state design practice has historically tended toward installing cable median barriers close to one or both of the two shoulders, or on an approach slope or back slope as far away as possible from the travel lanes. Barrier placement alternatives were determined from full-scale crash testing results. In addition, state DOTs have historically installed cable median barriers near shoulders and on 6:1 or flatter slopes based on successful crash testing of barriers installed on level terrain.

Unfortunately, systems installed near shoulders were more likely to be associated with a severe crash than installations near the center of the median, as discussed in Chapter 4, Section 4.2.9. Severe crash rates for installations near shoulders were approximately 15%, based on a limited sample, and 4.4%, for all crashes occurring further than 4 ft (1.2 m) from the center of the median. In contrast, the severe crash rate for barriers installed near the center of the median was 1.6%. Penetration frequency was 5.6% higher for barriers installed near the center of the

median than on approach or back slopes, but rollover frequency was 1.2% lower for this same comparison. However, these conclusions are applicable to medians wider than 40 ft (12.2 m). Narrower medians may experience a difference in crash rate distributions [20].

Flat medians, as compared to steep medians, enabled errant vehicles to oversteer and increase CG trajectory angles before crashing into the barrier. As the CG trajectory and orientation angles at impact increased, the likelihood of penetration or rollover increased as well. These roadside/median encroachments were usually caused by avoidance maneuvers or panic reactions to on-road conditions and/or situations.

Steeper median slopes can allow errant vehicles to launch into the air beyond the slope break point and potentially vault over a barrier. As a result, it would seem reasonable that the distributions of CG trajectory impact angles and impact speeds for barriers installed near shoulders as well as near V-ditch centers would be similar, although bumper and hood heights with respect to the barrier may not be similar. Higher-speed impact events were found to increase the severity of those crashes. Crash severity was also increased when vehicles were redirected back into adjacent travel lanes. In addition, vehicle redirection into adjacent travel lanes was more common when barriers were installed near median shoulders as compared to median centers.

Barriers installed near median centers significantly reduced the risk of re-entering adjacent travel lanes and potentially striking adjacent vehicles. Vehicles, which departed the road at low angles and were able to regain control, were also less likely to crash into the barrier, thus decreasing both nuisance hits and severe crash frequency. If barrier placement is not feasible near the center of divided highways, it is recommended that barrier placement occur as far as reasonably possible away from travel lanes using taller, more robust barrier systems.

The symmetric 6:1 V-ditch configuration also reduced the risk of override relative to steeper median slopes due to reduced propensity for “bounce-over”. As a vehicle was projected over the slope break point (SBP) and onto the front slope of a median, there was a physical separation which occurred between the nominal and actual bumper height positions above the ground [25-26]. The difference between actual and expected bumper positions in a crash increased with slope steepness. Steep-sloped ditches not only promoted override conditions due to vehicular launching over the SBP, but there was also a risk of the vehicle contacting the front slope and redirecting up the back slope, causing a redirective “leap” into or potentially over the barrier.

A risk analysis was conducted based on median terrain to determine bounce-over likelihood in 6:1 V-ditches wider than 40 ft (12.2 m). When allowing for a 20% difference between observed and actual bounce-over frequencies, vehicles were over 10 times more likely to underride the barrier than to vault over the barrier on slopes of 6:1 or flatter. Medians with 4:1 slopes more commonly resulted in “bounce-over” penetrations and overrides.

Some recommendations have been made regarding critical barrier placement in medians when considering the NCHRP Report No. 350 and MASH impact safety standards [26]. However, most prior crash testing studies were conducted using the NCHRP Report No. 350 or MASH crash test conditions at roadside departure. Due to the wide distribution of crash speeds, CG trajectory and orientation angles, and median slopes on a given section of road, barrier placement recommendations must be broad and incorporate a large spectrum of possible vehicle crash conditions.

All median barriers are roadside objects, and crashes with any roadside object can potentially pose a risk to occupants of errant vehicles. It was noted that for high-tension cable barrier systems, more than 50% of all severe injuries or fatalities were not caused by rollovers or

penetrations. Even for low-tension cable barrier systems, the barrier-related A+K crashes constituted a minimum of 30% of all serious or fatal crashes. As such, it is believed that a reduction in nuisance crashes into cable median barriers can also dramatically decrease the frequency of serious vehicle-to-barrier crashes.

9.4 Full-Scale Crash Testing

9.4.1 Background

Full-scale crash testing guidelines have advanced significantly since the introduction of such documents as NCHRP Report No. 153 [45] and the Transportation Research Circular (TRC) No. 191 [46]. Prior to the acceptance of NCHRP Report No. 230 [47] in 1981, crash testing was largely conducted ad hoc and according to engineering judgment. Standardized testing vehicles and impact conditions were required according to the criteria presented in NCHRP Report 230, but those guidelines were based on historical estimates of the practical worst-case impact scenarios, using subcompact small cars and large sedans as test vehicles.

As the number of light trucks and utility vehicles increased in the late 1980s, it became apparent that updates to the crash testing criteria were necessary. With the introduction and acceptance of crash testing criteria proposed in NCHRP Report No. 350 in 1993 [48], the standardized vehicles used to evaluate roadside appurtenances at any test level were changed to an 1,808-lb (820-kg) 820C small car and a 4,409-lb (2,000-kg) 2000P pickup truck. These vehicles were selected for several reasons: (1) the small car had a low mass and front hood height, which could increase risk to occupants due to high decelerations, occupant compartment deformation, or underride; (2) the larger and heavier 2000P vehicle was useful for testing structural adequacy of roadside appurtenances; and (3) the 2000P pickup truck was susceptible to instability, even rollover. These guidelines remained in effect for well over a decade, until MASH was accepted in 2009 [49].

With the introduction of MASH, criteria for conducting and evaluating full-scale crash tests were proposed based on real-world studies of more than 890 run-off-road crashes [22]. Vehicle selection was determined based on the 2nd and 95th percentile vehicles purchased in the United States based on data collected from vehicle sales between 2000 and 2004. A 5,000-lb (2,268-kg) 2270P pickup truck and a 2,425-lb (1,100-kg) 1100C small car were chosen as the most representative vehicles using similar arguments as were used following the acceptance of NCHRP Report No. 350. An optional mid-size 1500A vehicle weighing approximately 3,300 lb (1,497 kg) was also proposed if it was believed that barrier systems would be susceptible to crashes with this vehicle type.

9.4.2 Cable Barrier Crash Observations

The vehicles selected for use in full-scale crash testing according to the criteria presented in NCHRP Report No. 350 and MASH were not selected based on a historically poor performance with certain systems. As a result, crash tests have rarely been conducted with the most critical vehicle types or crash conditions maximizing containment failure risk.

A summary of the vehicles most commonly involved in penetration and rollover crashes with cable median barriers is shown in Table 28. Not surprisingly, vehicles most commonly associated with penetrations were typically either sharply-contoured or high bumper height, high CG location vehicles such as large SUVs. Examples of sharply-contoured vehicles include the Subaru Impreza, Acura Integra, Oldsmobile Alero, and Ford Taurus from model years 1996 to 2007. Likewise, rollovers were common with SUVs. The vehicles most commonly involved in rollovers were Chevrolet C1500, Ford Explorer, and Chevrolet Blazer.

Table 28. Vehicles Frequently Involved in (a) High Penetrations and (b) High Rollovers

| Vehicle | Number of Impacts | Number of Penetrations | Number of Rollovers | Penetration Rate | Rollover Rate |
|-------------------------|-------------------|------------------------|---------------------|------------------|---------------|
| Subaru Impreza | 11 | 6 | 0 | 54.5% | 0.0% |
| Chrysler PT Cruiser | 12 | 4 | 3 | 33.3% | 25.0% |
| Ford Crown Victoria | 14 | 4 | 0 | 28.6% | 0.0% |
| Ford Escape | 11 | 3 | 0 | 27.3% | 0.0% |
| Ford F250 | 24 | 6 | 5 | 25.0% | 20.8% |
| Acura Integra | 24 | 6 | 0 | 25.0% | 0.0% |
| Oldsmobile Alero | 12 | 3 | 0 | 25.0% | 0.0% |
| Ford F350 | 17 | 4 | 2 | 23.5% | 11.8% |
| Chevrolet Lumina | 18 | 4 | 0 | 22.2% | 0.0% |
| Chevrolet Impala | 23 | 5 | 1 | 21.7% | 4.3% |
| Buick Regal | 14 | 3 | 1 | 21.4% | 7.1% |
| Dodge Intrepid | 19 | 4 | 3 | 21.1% | 15.8% |
| Ford Taurus (1996-2007) | 48 | 10 | 6 | 20.8% | 12.5% |
| Nissan Sentra | 40 | 8 | 2 | 20.0% | 5.0% |
| Toyota 4 Runner | 25 | 5 | 6 | 20.0% | 24.0% |
| Chevrolet Camaro | 15 | 3 | 1 | 20.0% | 6.7% |
| Chevrolet S10 | 15 | 3 | 0 | 20.0% | 0.0% |
| Dodge Durango | 21 | 4 | 2 | 19.0% | 9.5% |
| Chevrolet Blazer | 37 | 7 | 9 | 18.9% | 24.3% |
| Chevrolet Astro | 16 | 3 | 2 | 18.8% | 12.5% |
| Chrysler Sebring | 23 | 4 | 0 | 17.4% | 0.0% |
| Toyota Tundra | 19 | 3 | 3 | 15.8% | 15.8% |
| Chevrolet Cobalt | 19 | 3 | 1 | 15.8% | 5.3% |
| Ford Escort | 33 | 5 | 2 | 15.2% | 6.1% |
| Volkswagen Jetta | 33 | 5 | 0 | 15.2% | 0.0% |
| Chevrolet Trailblazer | 28 | 4 | 3 | 14.3% | 10.7% |
| Jeep Liberty | 21 | 3 | 3 | 14.3% | 14.3% |
| Honda Civic | 130 | 18 | 5 | 13.8% | 3.8% |
| Ford Explorer | 81 | 11 | 20 | 13.6% | 24.7% |
| Pontiac Grand Am | 37 | 5 | 2 | 13.5% | 5.4% |
| Honda Accord | 118 | 15 | 4 | 12.7% | 3.4% |
| Saturn SL/SL1/SL2 | 41 | 5 | 3 | 12.2% | 7.3% |
| Pontiac Grand Prix | 33 | 4 | 1 | 12.1% | 3.0% |
| Toyota Celica | 10 | 3 | 2 | 30.0% | 20.0% |
| Chrysler Concorde | 7 | 3 | 2 | 42.9% | 28.6% |
| Lincoln Town Car | 7 | 3 | 0 | 42.9% | 0.0% |
| Mercury Tracer | 6 | 3 | 0 | 50.0% | 0.0% |
| Mitsubishi Mirage | 6 | 2 | 1 | 33.3% | 16.7% |
| Chrysler Cirrus | 6 | 2 | 0 | 33.3% | 0.0% |
| Toyota Matrix | 6 | 2 | 0 | 33.3% | 0.0% |
| Ford Aerostar | 5 | 2 | 0 | 40.0% | 0.0% |
| Mercury Grand Marquis | 4 | 2 | 0 | 50.0% | 0.0% |
| Oldsmobile 88 | 4 | 2 | 0 | 50.0% | 0.0% |
| Volkswagen Golf | 4 | 2 | 0 | 50.0% | 0.0% |

(a)

| Vehicle | Number of Impacts | Number of Penetrations | Number of Rollovers | Penetration Rate | Rollover Rate |
|---------------------------|--------------------------|-------------------------------|----------------------------|-------------------------|----------------------|
| Chevrolet C1500/2500/3500 | 32 | 2 | 8 | 6.3% | 25.0% |
| Ford Explorer | 81 | 11 | 20 | 13.6% | 24.7% |
| Chevrolet Blazer | 37 | 7 | 9 | 18.9% | 24.3% |
| Toyota 4 Runner | 25 | 5 | 6 | 20.0% | 24.0% |
| Dodge Ram 1500 | 27 | 3 | 6 | 11.1% | 22.2% |
| Ford F250 | 24 | 6 | 5 | 25.0% | 20.8% |
| Ford Ranger | 72 | 4 | 13 | 5.6% | 18.1% |
| Dodge Intrepid | 19 | 4 | 3 | 21.1% | 15.8% |
| Toyota Tundra | 19 | 3 | 3 | 15.8% | 15.8% |
| Jeep Liberty | 21 | 3 | 3 | 14.3% | 14.3% |
| Jeep Cherokee | 30 | 3 | 4 | 10.0% | 13.3% |
| Ford Taurus (1996-2007) | 48 | 10 | 6 | 20.8% | 12.5% |
| Chrysler PT Cruiser | 12 | 4 | 3 | 33.3% | 25.0% |
| Isuzu Rodeo | 11 | 2 | 4 | 18.2% | 36.4% |
| Dodge Grand Caravan | 11 | 2 | 3 | 18.2% | 27.3% |
| Ford Econoline | 11 | 1 | 3 | 9.1% | 27.3% |
| Chrysler Concorde | 7 | 3 | 2 | 42.9% | 28.6% |
| Mazda Tribute | 6 | 0 | 2 | 0.0% | 33.3% |
| Mazda 323 | 5 | 1 | 2 | 20.0% | 40.0% |

(b)

While a complete discussion of the vehicle factors contributing to barrier containment failures is beyond the scope of this report, several observations were made regarding the rates of containment failures on cable median barriers. There has been a trend in recent years away from sharply-contoured front end profiles, which was indicative in the crash data. Many of the vehicles on the high-penetration rate list are out of production. However, the Subaru Impreza and the Chevrolet Impala are still in production and are similar to the vehicles which struck the cable median barrier causing penetration. Alternatively, the high-rollover rate list is largely intact, with many vehicles still in production, such as the Forde Explorer, Toyota 4Runner, Dodge Ram, and others.

Notable omissions from the penetration list included the Geo Metro, Hyundai Accent, Pontiac Sunfire, Ford Focus, and Chevrolet Malibu, each of which were involved in less than 6.7% penetration crashes, but were involved in a total of more than 15 crashes. These vehicles

are not believed to be critical vehicles for use in crash testing and should be avoided when making the selection for appropriate high-penetration propensity vehicles.

Vehicles frequently involved in rollover crashes were typically high-CG vehicles. Two exceptions included the Dodge Intrepid and Ford Taurus with model years between 1996 and 2007. Neither of these vehicles are currently in production. However, 5 of the 7 vehicles involved in the highest number of rollovers are still in production: Ford Explorer, Chevrolet Blazer, Toyota 4Runner, Dodge Ram, and Ford F250. If testing for rollover propensity on cable median barrier systems is conducted, these vehicles should be readily available. It is of particular interest to note that the Dodge Ram ½-ton vehicle currently used in 2270P full-scale crash testing had a rollover rate of approximately 22%. As a result, the 2270P vehicle currently utilized for many MASH tests may be a critical vehicle involved in cable median barrier crashes, although the current impact conditions may not be as critical.

Small cars were not commonly involved in penetration crashes, in general. Exceptions to this observation, as expected, occurred with narrow front profile vehicles such as the Honda Accord, Honda Civic, and Ford Escort. Small vehicles with stiff front ends were also commonly involved in penetration crashes, such as the Chevrolet Cobalt and Volkswagen Jetta. The small number of critical small car vehicles is not surprising since crash testing according to NCHRP Report No. 350 and MASH has only showed critical behavior when tested in a V-ditch [50]. Vehicles demonstrating more frequent barrier failures may be necessary to improve future testing guidelines.

It has been frequently stated that the increased scrutiny applied to the cable median barriers recommended in this study places the barriers at a competitive disadvantage with respect to other barrier systems. However, cable median barriers were the only barriers which showed favorable performance on 6:1 slopes, and have the potential for application in steeper slopes.

Cable median barriers will continue to be less expensive to manufacture and install in divided medians than other median barrier types. If the concerns addressed in this study are satisfactorily addressed, the associated reduction in severe crash risk would make cable median barriers the safest barriers available for use on divided roadways.

Furthermore, this study should be used as a springboard to apply this type of system-specific analysis to other barrier systems en route to more specific, comprehensive guidelines for roadside safety appurtenance testing that can accurately predict worst-case scenarios and prevent serious crash occurrences. Without sufficient scrutiny applied to barrier system containment failures and methods to prevent such events from being propagated, it will be impossible to reduce the current rate of roadside fatalities with any meaningful and purposeful direction. In time, all barrier systems should be subjected to scrutiny on a crash-by-crash basis.

10 SUMMARY AND CONCLUSIONS

Cable median barrier crash data was collected from 12 state DOTs and analyzed to determine mechanisms of cable median barrier containment failures resulting in penetration and rollover crashes. It was determined that the composite rate of passenger vehicle penetration through cable median barriers was approximately 9.9%, and rollover occurrence was approximately 8.1%. Causation was also identified, and the crash database was segregated by predominant failure mechanism contributing to barrier penetration or rollover. By creating categories of penetration-related and rollover-related containment failures, the mutually exclusive rates of penetration and rollover were determined to be 9.3% and 5.1%, respectively. This observation led to a composite CMB containment failure rate of 14.6%.

Adverse weather conditions were determined to significantly reduce the propensity for rollover and penetration crash frequency. During rain or snow storms in which precipitation was falling, the rate of cable median barrier penetrations was decreased by approximately 35%, whereas the rate of rollovers was decreased by 70%. However, when roads were wet or snow-covered, penetration propensity was decreased by 6% and 49%, respectively. Rollover frequency was likewise reduced on wet and snow-covered roads by 76% and 47%, respectively. Based on this result, it is evident that friction has a significant effect on crash outcome in both penetration and rollover crashes. It was likely that the frictional contribution from all adverse weather events decreased the CG trajectory angle into the barrier, which in turn reduced the IS value of the crash during storms. The rate of penetration after storms was very similar to dry conditions, since vehicles returned to nominal travel speeds. Lower IS values at the time of impact somewhat reduced the likelihood of rollover and penetration. As a result, standard crash test conditions should not be altered from the nominally dry condition used in full-scale cable median barrier crash tests.

CG trajectory and orientation angles at impact were explored through a limited study of severe cable median barrier crashes in the state of Missouri. The high rate of high CG trajectory and orientation angle impacts in the severe crash database indicated a need to evaluate cable median barriers at higher CG trajectory and orientation angles. The 85th percentile impact condition for severe cable median barrier crashes was 39 degrees relative to a tangent line on the barrier. The currently-used 25 degree angle into cable median barrier installations only corresponds to the 70th percentile of CG trajectory angles.

The performance of each barrier system was not equal, but there was also no “silver bullet” cable median barrier system. It was determined that the cable median barrier type with the lowest rate of A+K crashes was the low-tension 3-cable median barrier. The lowest rate of severity of high-tension systems occurred on the Safence 4-cable median barrier. The highest frequency of A+K injuries was observed with the Nucor 3-cable median barrier. The lowest rate of rollover occurred with the Brifen WRSF. Frequencies of fatalities recorded with the Nucor and Brifen systems were lower than with the Trinity CASS system.

Insufficient information was present to make definitive conclusions about the Gibraltar or Safence systems. The limited data available for the Gibraltar systems suggested a high rate of rollover crashes, which was consistent with the rollover model shown in Figure 80.

Crash severities were related with containment failure rates, but the correlation was limited. Although many fatalities occurring with cable median barriers were caused by cross-median impacts and rollovers, other fatalities and many serious injuries were caused by other circumstances. The highest correlation of containment failure with crash severity occurred with the 3-cable median barrier, with nearly 70% of all fatalities and serious injuries related to either rollover or penetration. If containment failures were equally reduced for every barrier system, the

system with the highest expected rate of severe crash reduction would be the low-tension, 3-cable median barrier.

Penetration mechanisms were discussed in detail, and causes of penetrations were determined and analyzed for each system. The penetration mechanisms were classified into fundamental groupings: diving, prying, override, bounce-over, system failure, and large vehicle penetration events. Of these, the diving and prying penetrations were common on every cable median barrier system, while override penetrations were common on the CASS and Nucor systems. Generic cable median barrier crashes had the fewest number of override events, likely because of the weak top cable-to-post connection, and insufficient data was available to make deterministic conclusions about override penetrations for Brifen, Gibraltar, or Safence systems. Based on the analysis of penetration mechanisms, higher bottom cable tension, lower top cable tension, stronger bottom cable-to-post connections, and weaker top cable-to-post connections were recommended.

Furthermore, it was noted that every future TL-3 cable median barrier system transition may require the use of 4 cables, with the bottom cable located approximately 13 to 15 in. (330 to 381 mm) above the ground. The bottom cable should have strong resistance to lifting on the post, but which could be overridden. To reduce the propensity for override penetrations, the top cable should be located a minimum of 35 in. (889 mm) above the ground.

Short post spacing was not strongly correlated with increased resistance to penetration. The smallest post spacing observed in the database was located in Missouri on a stretch of low-tension, 3-cable median barrier. For approximately 1 mi (1.6 km) of barrier, the post spacing was reduced to 4 to 6 ft (1.2 to 1.8 m) on center. The barrier was located adjacent to one shoulder and protected vehicles from entering a median with an estimated 4:1 slope. However, two severe penetrations still occurred in this segment in a three-year period, both from the vehicles in

adjacent travel lanes. If post spacing alone could prevent penetrations, it is statistically unlikely that a barrier with this small post spacing would encounter two severe penetration crashes in a 1-mi (1.6-km) stretch of roadway in only three years. As a result, it is unlikely that the reduced post spacing utilized on the low-tension, 3-cable median barrier can prevent penetration crashes without additional modifications, such as stronger cable-to-post attachments. However, some systems, such as Brifen WRSF and Gibraltar, rely on cable engagement with the flanges of adjacent posts in addition to or in lieu of strong cable-to-post attachments. In these systems, post spacing may have a more significant effect on penetration propensity than in the low-tension, 3-cable median barrier.

Rollover causes were also explored in detail. Whereas penetration events tended to occur in similar patterns by barrier type, rollover events were similar irrespective to barrier type. Rollovers which occurred on cable median barriers were most commonly caused by interaction with median slopes, high orientation angles at impact, or tripping on post members. Several other factors, such as trailer attachments and tire loss, were also briefly discussed. However, it would be infeasible to uniquely accommodate most of these infrequent rollover causes. As with penetration events, rollovers caused by impacts with large vehicles were not addressed, since no barriers in this study were designed to accommodate semi-tractor trailers. Barrier improvements to reduce the risk of rollover included the use of weak collapsing posts, reduced cable tension, differential cable tension, and graded medians which favor moderate (i.e. 6:1 to 8:1) slopes.

Cable median barrier installations are being erected annually at a rapid pace. Many cable median barrier systems resulted in reductions in severe injury and fatal crashes due to cross-median crash reduction. Nonetheless, modifications to full-scale testing conditions, barrier design, and roadside design must be made to ensure optimal performance of each barrier system. By implementing these design changes, it is expected that at least 50% of all cable median

barrier related severe crashes could be mitigated, and that penetration rate by passenger cars could be reduced by as much as 80%.

11 RECOMMENDATIONS

11.1 Modifications to Barrier Designs

11.1.1 Cable-to-Post Attachments and Vertical Positions

An untested design concept has been proposed by researchers to address cable median barrier containment failures and involves a stratification of cable-to-post attachment strengths for high-tension cable median barrier systems. The stratification methodology is an attempt to reconcile post strength, post bending moment, vehicle geometry, vehicle crush strength, and principles of controlled redirection via energetically-favorable capture zones on the vehicle for optimum redirection performance for any barrier, whether located in a V-ditch or on flat ground. This design methodology would implement low-tension cables with low-strength cable-to-post attachments at the tops of the posts to minimize risk of excessively damaging the occupant compartments of small cars involved in cable barrier crashes. The upper vertical cable release loads should be low to prevent roof crush. Likewise, the upper horizontal cable release loads could be less than or equal to the load required to form a plastic hinge in the base of the post. Using this design principle, the top cable-to-post connection would be the weakest, but vehicles could still be redirected with a single, top cable.

The bottom cable on the posts could likewise have cable release loads proportional to the load required to initiate plastic hinge formation at the base of the post and should be located no higher than 15 in. (381 mm) from the ground. The vertical resistance for the bottom cable to be pushed down should be lower than the vertical cable resistance to raise up the post flange. Because of the low bottom cable height and resistance to vertical uplift, underride events will be less likely. Furthermore, most windshield crown heights are at least 24 in. (610 mm) above the ground. As such, there is little risk of impacting vehicles to dive in the median and underride the

bottom cable if it is located no higher than 15 in. (381 mm) and if it has a strong resistance to vertical rise. The design concept is shown schematically in Figure 82.

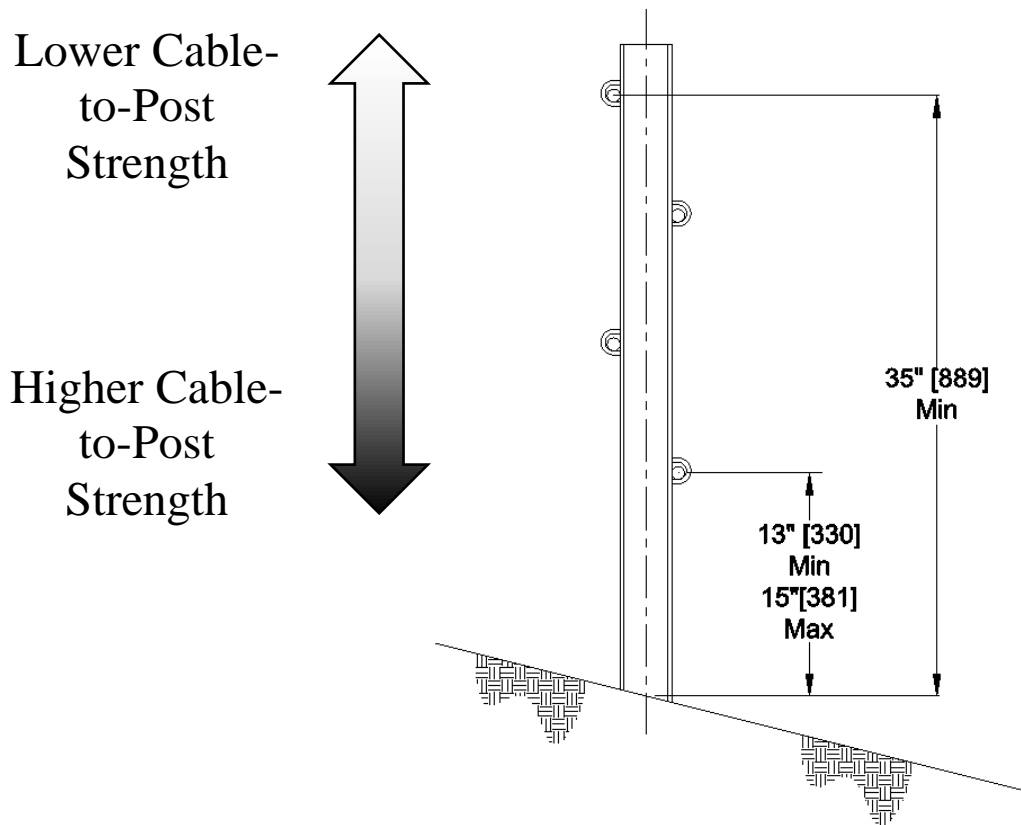

Figure 82. Cable Median Barrier Stratification Concept

Low-tension, 3-cable median barrier systems sustained the lowest frequency of large orientation angle-related rollovers but the highest number of post snagging related rollovers. This reduction is likely due to the lower cable tension and resulting lower lateral force on the vehicles applied by the cables. Common S3x5.7 (S76x8.5) post sections used with low-tension cable median barrier systems should be weakened, and improved cable-to-post connections should be utilized in order to experience a significant improvement in safety performance. Bottom cable-to-post attachments permitted frequent underrides and occasionally through-cable penetrations. Both of these penetration types would be significantly reduced if the bottom cable-to-post attachment was strengthened. The top cable-to-post attachment appeared to be optimal for the

low-tension, 3-cable median barrier; since, overrides were infrequent on this system. This cable-to-post attachment strength should be evaluated based on cable tension and height above the ground. Note that the nominal mounting height for the top cable in all low-tension, 3-cable median barrier systems in this study was 33 in. (838 mm).

11.1.2 Cable Tension

One design alteration, which may alleviate some rollover propensity caused by high-orientation angle crashes into high-tension cable barrier systems, is to reduce cable tension. A reduction in cable tension would decrease the lateral force imparted to a vehicle at the point of impact. Vehicles entering a V-ditch frequently have a pitch and roll displacement associated with the angled orientation in the ditch. As a result, interaction with cables in the ditch may cause an increased trip propensity due to roll and pitch moments imparted to the vehicle by the cables. Lower cable tension would permit a more gradual cable engagement with the vehicle and thus may reduce rollover propensity.

11.1.3 Number of Cables

One design improvement which would aid a low-tension, 3-cable, TL-3 median barrier system would be the addition of a fourth cable. The added cost of the fourth cable is an initial fixed cost which would not greatly increase annual maintenance costs associated with barrier repair. However, the anticipated safety improvement obtained by considering an additional cable is expected to be very high. Cost savings due to reduction in severe injuries and fatalities should far exceed the increased cost that the additional cable adds to system installations. In steeply-sloped medians or to reduce the rate of tractor-trailer penetrations, a fifth cable should be considered in a cable median barrier system.

11.1.4 Summary of Design Improvements

Several cable design improvements for cable barriers are recommended for further evaluation and are shown in Table 29.

Table 29. Summary of Barrier Design Improvement Recommendations

| Barrier System | Component | Problem | Recommended Design Improvements |
|------------------------------------|---------------------------|--|--|
| Nucor NU-CABLE | Cable to Post Attachments | Strong attachment prevents cable release after post is struck or deflects, causing continued engagement and post pullout from the ground or post fracture. | Eliminate nut from upper and middle clips. Redesign lower clip to release at a load near to the bending capacity of the post. |
| | Post Embedment | Frequent post pullout from ground or sockets. | Extend embedment depth to optimum length determined by component testing. Deepen embedment in socket to optimum length determined by component testing. |
| | Cable Heights | Insufficient number of cables to prevent penetrations. | Increase the standard number of cables in the TL-3 design to 4. Place the top cable at least 35 to 38 in. (890 to 965 mm) above ground, and the bottom cable at approximately 13 to 15 in. (330 to 381 mm). |
| Trinity CASS | C-Shape Posts | Frequently contribute to rollover. | Drill weakening holes at ground line in corners of post to facilitate post collapse and reduce the strong-axis yield moment. Consider breakaway alternative instead of post deformation as primary failure mechanism. |
| | Post Slot | If vehicles make first contact with post instead of cables, posts can be pushed down while still retaining cables, increasing rollover propensity. | Weaken the flange or web via slot or saw cut adjacent to middle or upper cable(s) to reduce risk of posts pushing cables downward. |
| | Cable Spacer | Vehicles which "dive" under cables are subjected to large vertical loads which can crush occupant compartments or increase ridedown accelerations. | Add additional bottom cable to prevent underride. Consider independent cable suspension within the slot or removal of at least one cable from the slot. |
| Brifen WRSF | Cable to Post Attachments | Bottom cable attachments using "roller" to maintain cable height contributes to diving and prying underride failures. | Add physical attachment to resist vertical displacement of bottom cable. Lower bottom cable height to 13 to 15 in. (330 to 381 mm) to reduce underride potential. Vertically separate 2nd and 3rd cables in TL-3 system. |
| | Cable Weave | Cable weave on bottom cable has contributed to rollover when wheel on impact side of vehicle overrides cable and causes pinch point at post. | Consider eliminating bottom cable weave or reduce height of bottom cable. |
| | Override | Large passenger vehicles can override system. | Increase height of top cable in TL-3 system. |
| Blue Systems Safence | C-Shape Posts | Similar concern as Trinity CASS. | See comments on Trinity CASS. |
| | Post Slot | | |
| | Cable Spacer | | |
| Gibraltar | Post Spacing | Large post spacing significantly increases risk of penetration by reducing lateral constraints on cables. | Decrease standard post spacing. Limit maximum post spacing to 10 ft (3.0 m) on centers. |
| | Post Strength | Tube post section does not completely collapse on weak-axis impact and forms ramp contributing to rollover. | Add weakening element to tube posts to completely collapse after impact. |
| Low-Tension 3-Cable Median Barrier | Cable to Post Attachments | Bottom and middle cables release from posts at low loads, causing extensive cable displacements when one cable redirects vehicle, and can increase penetration propensity. | Increase bottom and middle cable pullout load vertically and horizontally. Consider use of a retrofit strengthener which adds pullout resistance. |
| | Cable Heights | Barrier is susceptible to diving and prying underride failures. | Add fourth cable between 13 and 15 in. (330 to 381 mm). Apply stronger cable-to-post connection resisting vertical uplift and back side pullout. |
| | Post Strength | Post strength frequently contributes to rollover. | Slot, cut, or alter posts to make weaker. Apply weakened tube or pipe-section posts which will flatten completely when impacted. |

11.2 Barrier Placement in Medians

Many medians have slopes which may vary widely, even within a section spanning only one mile (1.6 km). As such, it is impossible to know *a priori* the actual slope in front of or behind a barrier before it is installed in the median. Thus, every barrier system should be crash tested and evaluated on the front and back slopes of a 4:1 V-ditch in the most critical configurations, which were determined and are discussed in Reference 20. Crash testing on the 4:1 slope or in a narrow 6:1 V-ditch may still be necessary if it is recommended for use on slopes shallower than or equal to 6:1 because of median geometry variations. These matrices should more adequately ensure that cable barriers can accommodate errant vehicles traversing sloped medians under tracking conditions.

Note that placing cable median barriers along both shoulders will not necessarily prevent all penetrations, cross-median crashes, or rollovers. Penetration crashes were nearly as common when barriers were impacted at the shoulders as when they occurred in the center of the ditch. Rollover crashes commonly occurred with low CG trajectory angles but high orientation angles. Rollover frequency was also greater when cable barriers were located adjacent to shoulders than in other locations; since, roadways typically have higher-friction surfaces which can increase the tripping moment on the vehicle and cause larger changes in the CG trajectory angle with the same steering input applied. Whenever convenient, it is recommended that cable median barriers be placed as close to the center of the median as possible.

11.3 Full-Scale Crash Testing

11.3.1 Full-Scale Crash Testing on Slopes

Due to the wide range of possible impact conditions which could occur on any cable median barrier, a variety of underride and override barrier impact conditions should be considered likely unless impacts with similar conditions cannot be observed with regular

frequency in real-world crash databases. Override penetrations, underride penetrations, and rollovers were observed for barrier systems regardless of approach slope, back slope, and median placement. Using crash data as an indicator, it will likely be necessary to utilize much of the crash-testing matrix recommended in Reference 20. Testing in accordance with these matrices will likely prevent many future penetration and rollover crashes.

11.3.2 Impact Conditions

Based on the impact conditions observed in this report, the 85th percentile CG trajectory angle involved in serious cable median barrier crashes was 39 degrees. Since the severe crashes followed the trend of all penetration crashes, based on the observation of Missouri and North Carolina data, full-scale crash testing to evaluate propensity for penetrations should be conducted at the higher CG trajectory angle of 39 degrees in future testing.

Based on the plot of impact angle shown in Figure 22, many rollovers in Missouri were observed when the initial orientation angle was approximately 45 degrees. In fact, the only severe crashes which occurred with orientation angles between 35 and 55 degrees were either penetration or rollover crashes. An orientation angle of 45 degrees is recommended for full-scale crash testing; since, crashes occurring at CG trajectory angles greater than 10 degrees were frequently oversteering crashes.

In order to test system susceptibility to low-CG trajectory angle, high-orientation angle crashes with SUV and light truck vehicles, the 50th percentile CG trajectory angle of 18 degrees is recommended. This angle is lower than the current 25-degree angle used in full-scale crash testing, but it should still be representative of a practical worst-case impact condition when combined with the 45-degree orientation angle.

The currently-used impact speed of 62.1 mph (100.0 km/h) appears to be representative of the 85th percentile condition, although an actual speed distribution was not available.

However, the median impact speed estimated by responding officers in Ohio was approximately 60 mph (97 km/h), and the average estimated impact speed was 58.1 mph (93.5 km/h). Furthermore, the speed limit on interstates in Ohio was only 65 mph (105 km/h). This data suggests that impact speeds used in full-scale crash testing should not be reduced.

11.3.3 Vehicle Selection

The crash testing of a system according to the TL-3 test criteria found in NCHRP Report No. 350 may not have been tested with the most critical impact angles and also may not have used the most critical vehicles. Barrier systems should also be evaluated with widely-purchased vehicles which have the greatest propensity to cause barrier failure. Although many of the vehicles shown in Table 28 are no longer being produced, an analysis is being conducted to identify critical features of vehicles which contribute to increased rollover or penetration propensity.

Penetration sensitivity testing should be conducted with low-profile mid-size or full-size cars for full-scale tests, which may not necessarily be the lightest, small cars. Very few small car crash tests have been conducted under recent impact safety standards on cable barrier systems; since, these crashes were not believed to be critical. Small car crashes are only critical if an occupant makes contact with the barrier, the vehicle penetrates over, under, or through the system, if cables crush the occupant compartment or cause rapid decelerations, or if the vehicle trips and rolls over. All of these conditions were infrequent in the available database of real-world cable barrier crashes. Unless a critical vehicle is selected, conducting crash tests using small cars would likely waste valuable research money.

11.3.4 Summary of Full-Scale Crash Testing Recommendations

The recommended impact conditions for future full-scale crash testing of cable median barriers are shown in Table 30. A diagram of the crash testing impact conditions is shown in Figure 83.

Table 30. Recommended Crash Testing Impact Conditions for Cable Median Barriers

| Test No. | Impact Speed, V (mph) | CG Trajectory Angle, ϕ (deg) | Orientation Angle, θ (deg) | Vehicle Class | Description |
|----------|-----------------------|-----------------------------------|-----------------------------------|--------------------------------------|--|
| 3-10A | 62.1 | 39 | 45 | Passenger Car | Passenger car penetration prying/override test. Impact should occur 2 ft (0.6 m) downstream of post. Recommended vehicles include: Acura Integra, Chevrolet Impala, Chevrolet Lumina, Dodge Intrepid, Ford Escort, Ford Taurus (model years before 2008), Honda Accord, or Subaru Impreza. |
| 3-11A | 62.1 | 39 | 45 | SUV, Pickup Truck, or Commercial Van | High-angle override test. Impact should be 4 in. (102 mm) upstream of post. Recommended vehicles include Chevrolet Blazer, Ford Explorer, Ford Escape, Toyota 4Runner, Toyota Tundra, or commercial van vehicles. |
| 3-11B | 62.1 | 7 | 7 | SUV, Pickup Truck, or Commercial Van | Low-angle override test. Should be conducted in ditch on 6:1 approach slope. Vehicles should be similar to those in test 3-11A. |

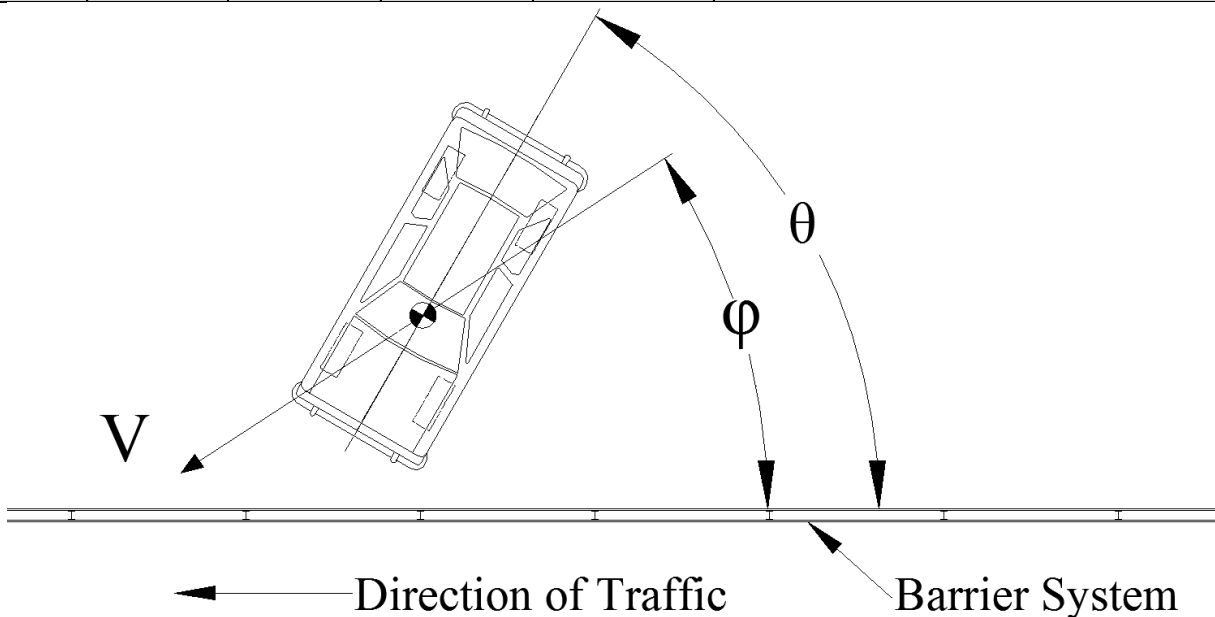

Figure 83. Representative Crash Testing Impact Diagram

These crash tests are recommended to replace the current TL-3 MASH crash test nos. 3-10 and 3-11 which are required for cable barrier systems and should be conducted on level, flat terrain unless otherwise specified. These tests are intended to supplement V-ditch testing of cable median barriers [20].

However, current limitations on crash testing procedures may limit the ability of agencies to conduct non-tracking and partially-skidding crash tests. Until the necessary apparatuses are developed to conduct crash testing with the recommended impact conditions, full-scale crash tests should be conducted at the CG trajectory angles identified in Table 30 and in fully-tracking conditions. Additional research to develop crash testing apparatus to conduct full-scale crash tests with off-tracking conditions will be necessary.

If the roadside safety community intends to reduce the number and frequency of cable median barrier containment failures, updates to existing testing criteria should be considered to reflect the more realistic “practical worst-case” impact scenarios. Whereas data per each system was not historically available, better data is now available to guide the redesign of systems to obtain the maximum possible safety improvement. The matrix provided in Table 30 is expected to cover the most critical crash conditions. Test no. 3-10A may incorporate a small car if a small car is shown to be most critical, but currently there is no plan to incorporate a separate crash test specifically for small cars.

12 REFERENCES

1. Graf, V.D., and Wingerd, N.C., *Median Barrier Warrants*, California Department of Public Works, Sacramento, 1968.
2. Nystron, K., *Median Barrier Study Warrant Review – 1997*, Report No. CALTRANS-TE-97-02, California Department of Transportation, Sacramento, 1997.
3. Hunter, W.W., J.R. Stewart, K.A. Eccles, H.F. Huang, F.M. Council, and D.L. Harkey. “Three-Strand Cable Median Barrier in North Carolina: An In-Service Evaluation,” Paper No. 01-0375, Presented at the Transportation Research Board Annual Meeting, January 2001.
4. Murphy, B., *Median Barriers in North Carolina – Long Term Evaluation*, Presentation at the Missouri Traffic and Safety Conference meeting, May 16, 2006, <<http://www.transportation.org/sites/aashtotig/docs/NC%20Info%20for%20Missouri%20Median%20Conference%2051606%20-%20Slides%20Updated%20as%20of%2021407.pdf>>
5. Gabler, H.C., Gabauer, D.J., and Bowen, D., *Evaluation of Cross-Median Crashes*, Final Report to the New Jersey Department of Transportation, Report No. FHWA–NJ–2005-04, Rowan University, February 2005.
6. Noyce, D.A., *Reducing Crossover Crashes in Wisconsin*, Wisconsin TOPS Lab, 2005.
7. Witte, A.S., Noyce, D.A., Bill, A.M., and Chapman, J.R., *A Five-Year Analysis of the Safety Impacts of Crossover Median Crashes in Wisconsin*, Final Report to the Wisconsin Department of Transportation, Wisconsin TOPS Lab, June 2007.
8. Davis, G.A., *Cross-Median Crashes: Identification and Countermeasures*, Final Report to the Minnesota Department of Transportation, Report No. MN/RC 2008-17, June 2008.
9. Hiss, J.G.F. Jr., and Bryden, J.E., *Traffic Barrier Performance*, New York Department of Transportation, May 1992.
10. Ray, M.H. and Weir J.A., *In-Service Performance Evaluation of Post-And-Beam Guardrails in Connecticut, Iowa, and North Carolina*, Worcester Polytechnic Institute, February 28, 1999.
11. Ross, H.E. Jr., Smith, D.G., Sicking, D.L., and Hall, P.R., *Development of Guidelines for Placement of Longitudinal Barriers on Slopes*, Transportation Research Report No. 3659-2, Texas Transportation Institute, May 1983.
12. *Evaluation of Cable Median Barrier Performance in Missouri*, Missouri Department of Transportation (in progress).
13. Mak, K.K., Sicking, D.L., and Coon, B.A., *Identification of Vehicle Impact Conditions Associated with Serious Ran-off-Road Crashes*, National Cooperative Highway Research Report No. 665, Transportation Research Board, Washington, D.C., 2010.

14. Sicking, D.L., F.D.B. Albuquerque, K.A. Lechtenberg, and C.S. Stolle. "Guidelines for Implementation of Cable Median Barrier". *Journal of the Transportation Research Board*, Transportation Research Record No. 2120, Washington, D.C., 2009, p. 82-90.
15. "NOAA's 1981-2010 Climate Normals", NOAA Satellite and Information Service, National Environmental Satellite, Data, and Information Service (NESDIS), Accessed June 2012. <<http://www.ncdc.noaa.gov/oa/climate/normal/usnormals.html>>
16. "Annual Average Precipitation Map 1971-2000", National Oceanic and Atmospheric Administration and Oregon State University, PRISM Climate Group, Accessed July 2012. <http://prism.oregonstate.edu/products/viewer.phtml?file=/pub/prism/us_30s/graphics/ppt/Normal/us_ppt_1981_2010.14.png&year=1981_2010&vartype=ppt&month=14&status=final>
17. Bullard, D.L. Jr., and Menges, W.L., *Crash Testing and Evaluation of the WSDOT Three Strand Cable Rail System*, Final Report to the Washington State Department of Transportation, Research Study No. 270687-WDT2, Texas Transportation Institute, Texas A&M University, June 1996.
18. Terpsma, R.J., Polivka, K.A., Sicking, D.L., Rohde, J.R., Reid, J.D., and Faller, R.K., *Evaluation of a Modified Three-Cable Guardrail Adjacent to Steep Slope*, Final Report to the Midwest States Regional Pooled Fund Program, MwRSF Research Report No. TRP-03-192-08, Midwest Roadside Safety Facility, University of Nebraska-Lincoln, March 2008.
19. Molacek, K.M., Lechtenberg, K.A., Faller, R.K., Rohde, J.R., Sicking, D.L., Bielenberg, R.W., Reid, J.D., Stolle, C.J., Johnson, E.A., and Stolle, C.S., *Design and Evaluation of a Low-Tension Cable Median Barrier System*, Final Report to the Midwest States Regional Pooled Fund Program, MwRSF Research Report No. TRP-03-195-08, Midwest Roadside Safety Facility, University of Nebraska-Lincoln, December 2008.
20. Mongiardini, M., Faller, R.K., Rosenbaugh, S.K., and Reid, J.D., *Test Matrices for Evaluating Cable Median Barriers Placed in V-Ditches*, Final Report to the Midwest States Regional Pooled Fund Program, MwRSF Research Report No. TRP-03-265-12, Midwest Roadside Safety Facility, University of Nebraska-Lincoln, July 2012.
21. Stolle, C.S., Bohlken, J.C., Lechtenberg, K.A., and Sicking, D.L., "Recommended Impact Conditions for Side-Impact and Non-Tracking Testing", Paper No. 11-3806, Presented at the 90th Annual Meeting of the Transportation Research Board, January 25, 2011.
22. Mak, K.K., Sicking, D.L., and Coon, B.A., *Identification of Vehicular Impact Conditions Associated with Serious Ran-Off-Road Crashes*, National Cooperative Highway Research Program Report No. 665, Transportation Research Board, Washington, D.D., 2010.
23. Gabler, H.C., Gabauer, D.J., and Bowen, D., *Evaluation of Cross-Median Crashes*, Final Report to the New Jersey Department of Transportation, Report No. FHWA-NJ-2005-04, Rowan University, February, 2005.

24. Bligh, R., Miaou, S.-P., Lord, D., and Cooner, S., *Median Barrier Guidelines for Texas*, Final Report to the Texas Department of Transportation, Report No. FHWA/TX-06/0-4254-1, Texas Transportation Institute, Texas A&M University, January 2006.
25. Marzougui, D., and Opiela, K., *Analyzing the Potential Interface Effectiveness of Cable Barriers in Asymmetrical Median Cross-Sections*, National Crash Analysis Center Working Paper No. NCAC-2011-W-001, National Crash Analysis Center, February 2011.
26. Marzougui, D., Mohan, P., Kan, S., and Opiela, K., "Performance Evaluation of Low Tension Three Strand Cable Median Barriers", *Journal of the Transportation Research Board*, Issue 2025, 2007, pp. 34-44.
27. Stolle, C.S., Reid, J.D., and Lechtenberg, K.A., *Development of Advanced Finite Element Material Models for Cable Barrier Wire Rope*, Final Report to the Mid-America Transportation Center, FHWA Region VII University Transportation Center, MwRSF Report No. TRP-03-233-10, August 2010.
28. Daniello, A., and Gabler, H.C., "The Effect of Barrier Type on Injury Severity in Motorcycle to Barrier Collisions in North Carolina, Texas, and New Jersey", Paper No. 11-3958, Proceedings of the 90th Annual Meeting of the Transportation Research Board, Washington, D.C., 2011.
29. "NU-CABLE Cable Barrier Systems Installation Manual: Test Level-3 for 6:1 Slopes", Version 2011.09A, Accessed April 25, 2012, <http://nucorhighway.com/files/NU-CABLE_DOCUMENT_INSTALLATIONMANUAL_TL3_SIXTOONE.pdf>
30. Nucor NU-CABLE TL-3 Barrier Standard Design Details, Accessed April 25, 2012, <http://nucorhighway.com/files/TL3_HTCB_STANDARD.pdf>
31. "CASS C-Shaped Posts", Trinity Highway Products, Updated 2007. <<http://www.highwayguardrail.com/products/cass.html>>
32. "CASS TL-3", Trinity Highway Products, Updated 2007. <<http://www.highwayguardrail.com/products/cassTL3.html>>
33. "2002 Dodge Stratus", CarLotBot.com, 2009. <<http://carlotbot.com/car/365062>>
34. "Supplemental Specifications and Attachments: Bid Details", Texas Department of Transportation Bid Sheet Drawings, 2012, <<ftp://ftp.dot.state.tx.us/pub/txdot-info/gsd/pdf/wrsftl3.pdf>>
35. Graham, M.D., Burnett, W.C., Gibson, J.L., and Freer, R.H., *New Highway Barriers: The Practical Application of Theoretical Design*, Highway Research Record No. 174, New York State Department of Transportation, 1967, pp. 88-167.
36. Bullard, D.L. Jr., and Menges, W.L., *Crash Testing and Evaluation of the WSDOT Three Strand Cable Rail System*, Final Report to the Washington State Department of Transportation, Research Study No. 270687-WDT2, Texas Transportation Institute, Texas A&M University, June 1996.

37. Phillips, R.G., Tyrell, A.B., Bryden, J.E., and Fortuniewicz, J.S., *Cable Guiderail Breakaway Terminal Ends*, Research Report No. 148, New York State Department of Transportation, 1998.
38. Fang, H., Weggel, D.C., Bi, J., and Martin, M.E., *Finite Element Evaluation of Two Retrofit Options to Enhance the Performance of Cable Median Barriers*, Final Report to the North Carolina Department of Transportation, University of North Carolina-Charlotte, June, 2009.
39. Reid, J.D., and Coon, B.A., "Finite Element Modeling of Cable Hook Bolts", Conference Proceedings, Presented at the 7th International LS-DYNA Users Conference, Dearborn, Michigan, May 2002, pp. 17-11 through 17-23.
40. Thiele, J.D., Bielenberg, R.W., Faller, R.K., Sicking, D.L., Rohde, J.R., Reid, J.D., Polivka, K.A., and Holloway, J.C., *Design and Evaluation of High-Tension Cable Median Barrier Hardware*, Final Report to the Midwest States Regional Pooled Fund Program, MwRSF Research Report No. TRP-03-200-08, Midwest Roadside Safety Facility, University of Nebraska-Lincoln, February 2008.
41. Stout, D. and Hinch, J., *Test and Evaluation of Traffic Barriers*, Research Report No. FHWA-RD-89-119, ENSCO, Inc., Springfield, Virginia, April 1989.
42. Nelson, R.M., Sicking, D.L., Faller, R.K., Reid, J.D., Rohde, J.R., Polivka, K.A., and Hascall, J.A., *Evaluation of Alternative Cable Anchor Designs and Three-Cable Guardrail Adjacent to Steep Slope*, Final Report to the Midwest States Regional Pooled Fund Program, MwRSF Research Report No. TRP-03-155-05, Midwest Roadside Safety Facility, University of Nebraska-Lincoln, February 2005.
43. Hitz, R.A., Molacek, K.J., Stolle, C.S., Polivka, K.A., Faller, R.K., Rohde, J.R., Sicking, D.L., Reid, J.D., and Bielenberg, R.W., *Design and Evaluation of a Low-Tension Cable Guardrail End Terminal System*, Final Report to the Midwest States Regional Pooled Fund Program, MwRSF Report No. TRP-03-131-08, Midwest Roadside Safety Facility, University of Nebraska-Lincoln, July 2008.
44. "TL-3 System Drawings: System Drawing (Standard)", Gibraltar, Updated October 13, 2008. <<http://gibraltartx.com/cable-barriers/drawings>>
45. Bronstad, M.E., and Michie, J.D., "Recommended Procedures for Vehicle Crash Testing of Highway Appurtenances", *National Cooperative Highway Research Program (NCHRP) Report No. 153*, Transportation Research Board, National Research Council, Washington, D.C., 1974.
46. *Recommended Procedures for Vehicle Crash Testing of Highway Appurtenances*, Transportation Research Circular No. 191, Transportation Research Board, National Academy of Sciences, Washington, D.C., February 1978.

47. Michie, J.D., *Recommended Procedures for the Safety Performance Evaluation of Highway Appurtenances*, National Cooperative Highway Research Program (NCHRP) Report No. 230, Transportation Research Board, Washington, D.C., March 1981.
48. Ross, HE Jr., DL Sicking, RA Zimmer, and JD Michie, *Recommended Procedures for the Safety Performance Evaluation of Highway Features*, National Cooperative Highway Research Program Report 350, Transportation Research Board, National Research Council, Washington, DC. 1993.
49. Manual for Assessing Safety Hardware (MASH), American Association of State Highway and Transportation Officials (AASHTO), Washington, D.C., 2009.
50. Wiebelhaus, M.J., Johnson, E.A., Sicking, D.L., Faller, R.K., Lechtenberg, K.A., Rohde, J.R., Bielenberg, R.W., Reid, J.D., and Rosenbaugh, S.K., *Phase I Development of a Non-Proprietary, Four-Cable, High-Tension Median Barrier*, Final Report to the Midwest States Regional Pooled Fund Program, MwRSF Report No. TRP-03-213-11, Midwest Roadside Safety Facility, University of Nebraska-Lincoln, December 2011.
51. Schmidt, J.D., Sicking, D.L., Faller, R.K., Lechtenberg, K.A., Bielenberg, R.W., Reid, J.D., and Rosenbaugh, S.K., *Phase II Development of a Non-Proprietary, High-Tension Cable Median Barrier*, Final Report to the Midwest States Regional Pooled Fund Program, MwRSF Report No. TRP-03-253-12, Midwest Roadside Safety Facility, University of Nebraska-Lincoln, March 2012.

13 ADDITIONAL RELEVANT STUDIES

Sposito, B., and Johnston, S., *Three-Cable Median Barrier: Final Report*, Final Report to the Oregon Department of Transportation, Report No. OR-RD-99-03, July 1998.

Monsere, C.M., Sposito, B., and Johnston, S., Safety Effectiveness and Operating Performance of Three-Cable Median Barrier on Interstate 5 in Oregon, 2003.

McClanahan, D., Albin, R.B., and Milton, J.C., “Washington State Cable Median Barrier In-Service Study”, Submitted to the Journal of the Transportation Research Board, November 2003.

Hammond, P. and Batiste, P., Cable Median Barrier: Reassessment and Recommendations Update, Final Report to the Governor of the State of Washington, October 2009.

Medina, J.C., High-Tension Cable Median Barrier: A Scanning Tour Report, Final Report to the Illinois Department of Transportation, Report No. FHWA-IL/UI-TOL-18, University of Illinois Urbana-Champaign, January 2006.

Outcalt, W., Cable Guardrail, Interim Report to the Colorado Department of Transportation, Report No. CDOT-DTD-R-2004-10, June 2004.

Sharp, B. and Stewart, R., High-Tension Cable Median Barrier (Brifen, Trinity) at UDOT, Report on Experimental Features Submitted to the Utah Department of Transportation, Report No. UT-04.03, May 2004.

Managing Vegetation Under Cable Median Barriers: Mow Strip Design and Practices, Final Report to the Wisconsin State Department of Transportation, CTC & Associates LLC, December 2007.

Chandler, B., “Eliminating Cross-Median Fatalities”, Transportation Research News, Issue 248, January-February 2007, pp. 29-31.

Kenyon, W. D., *Cable Guiderail Tension*, Final Report to the Federal Highway Administration, New York Research Report No. FHWA/NY/RR-85/124, New York Department of Transportation, July 1985.

END OF DOCUMENT